

GERDA®

HERSTELLER VON TÜREN DER KLASSE PREMIUM



HAUSTÜREN

THERMO PRIME | THERMO PREMIUM | OPTIMA

INHALTSVERZEICHNIS **GERDA**[®]

SCHRITT-FÜR-SCHRITT-ANLEITUNG ZUR NEUEN AUSSENTÜR

TEDEE POWERED BY GERDA	3
SOFORT VERFÜGBARE TÜREN	4
WAS SOLL MAN ÜBER GERDA-TÜREN WISSEN	8
WAS SOLL MAN BEI DER AUSWAHL DER GERDA-TÜREN BEACHTEN	9
GERDA THERMO PRIME 75	12-13
GERDA THERMO PREMIUM 75	14-15
GERDA THERMO PREMIUM 60	16-17
GERDA OPTIMA 60	20-21
GERDA OPTIMA 50	22-23
TÜREN AIR GLASS	26-31
TÜREN QUADRO	32-53
TÜREN ELITE 3D	54-55
TÜREN TEMPO	56-75
TÜREN CLASSIC	76-85
TÜREN OPTIMA 60 DUO	86-87
REICHHALTIGE FARBPALETTE	88-89
ALUMINIUM-SEITENLICHTER	90-91
ZUBEHÖR-SET	92-93
OPTIONALE AUSSTATTUNG	94-99
MASSE DER TÜREN UND TÜRRAHMEN'	100-105

VERWANDELN SIE IHR SMARTPHONE IN EIN INTELLIGENTES TÜRSCHLOSS



ÖFFNEN SIE DIE TÜR PER SMARTPHONE

Öffnen und schließen Sie die Tür und überprüfen Sie den Schloss-Status von einem beliebigen Ort auf der Welt. Dank der automatischen Öffnungsfunktion müssen Sie Ihr Smartphone nicht aus der Hosentasche oder der Handtasche nehmen. Das Schloss wird Ihre Anwesenheit selbst feststellen und Sie ins Haus hereinlassen. Auf dieselbe Weise können Sie die Selbstschließfunktion einstellen.

EFFIZIENTER AKKUMULATOR

Gerda-Ingenieure haben in Zusammenarbeit mit einer südkoreanischen Forschungseinrichtung einen dedizierten und hocheffizienten Akku in kompakter Größe entwickelt. Dieser Akku versorgt den Mechanismus mit Strom für eine Betriebszeit bis zu sechs Monaten. Wenn es jedoch notwendig sein wird, den Akku aufzuladen, dann informiert Sie das Schloss darüber selbst und den Akku laden Sie in nur einer Nacht.

SICHERHEIT

Der Schlossantriebsmechanismus hat eine innovative und patentierte Bauweise, die von Gerda-Ingenieuren entwickelt wurde. Die Software wurde von IoT-Experten der Firma tedee entwickelt. Dank der intuitiven App können Sie überwachen, wer die Tür wann geschlossen oder geöffnet hat. Sie können zudem per Fernzugriff virtuelle Schlüssel vergeben.

SET

TEDEE LOCK + TEDEE BRIDGE + SCHLISSZYLINDER DER KLASSE 6



SCHLISSZYLINDER DER KLASSE 6, IM SET ENTHALTEN

- ✓ EINBRUCHSICHERER SCHLISSZYLINDER. NEUE KONSTRUKTION DES SCHLISSZYLINDERS MIT EINER ABSICHERUNG GEGEN EINEN BUMPING-VERSUCH UND WIRKSAMEN BOHRSCHUTZLÖSUNGEN.



MONTIEREN SIE DAS GERDA TEDEE-SCHLOSS

- ✓ SCHIEBEN SIE DAS SCHLOSS AUF DEN GERDA-SCHLISSZYLINDER, STELLEN SIE SEINE POSITION EIN UND FIXIEREN SIE ES MIT EINER SCHRAUBE. SIE WERDEN DAFÜR NICHT MEHR ALS ZWEI MINUTEN BENÖTIGEN. PRÜFEN SIE, OB BEIM DREHEN DES KNAUFES DIE RIEGEL HERAUSFAHREN.



INSTALLIEREN SIE DIE APP AUF IHREM SMARTPHONE

- ✓ LADEN SIE DIE GERDA TEDEE-APP AUS DEM APPLE STORE ODER GOOGLE PLAY HERUNTER. MELDEN SIE SICH AN UND SCHALTEN SIE BLUETOOTH, DEN ORTUNGSDIENST UND DEN INTERNETZUGANG EIN. FÜGEN SIE DAS SCHLOSS HINZU UND GEBEN SIE EINEN AKTIVIERUNGSCODE EIN.



SCHLIESSEN SIE BRIGDE AN

- ✓ FINDEN SIE EINE NETZBUCHSE, DIE SICH MÖGLICHSST NAHE DES TEDEE-SCHLOSSES BEFINDET, UND SCHLIESSEN SIE BRIDGE AN DIE BUCHSE AN. DIES ERMÖGLICHT IHNEN EINE KOMPLETTE KONTROLLE ÜBER DAS SCHLOSS PER INTERNET, UNABHÄNGIG VON DEM ORT; AN WELCHEM SIE SICH BEFINDEN.

SOFORT VERFÜGBARE TÜREN

GERDA®

OPTIMA 60



MILANO 8 NS1



HANOVER NS6

TÜRENMODELL	OPTIMA 60
GRÖSSE	90E
FARBE	ANTHRAZIT (FKG), GOLDEICHE (FDE)
TÜRZARGE	PERFOTHERM
SCHEIBE	MATT
SCHWELLE	ALUMINIUMSCHWELLE
ARMATUREN	TÜRROSETTEN BLOCK TÜRDRÜCKER - TÜRDRÜCKER MIT SCHLIESSZYLINDERN

TÜRENMODELL	OPTIMA 60
GRÖSSE	90E
FARBE	ANTHRAZIT (FKG), GOLDEICHE (FDE)
TÜRZARGE	PERFOTHERM
SCHEIBE	MATT
SCHWELLE	ALUMINIUMSCHWELLE
ARMATUREN	TÜRROSETTEN BLOCK TÜRDRÜCKER - TÜRDRÜCKER MIT SCHLIESSZYLINDERN

EINGebaute TÜREN (TÜRBLATT + TÜRRAHMEN + SCHWELLE)



TOKIO 2A TMMA



W00 FLACH

TÜRENMODELL	OPTIMA 60
GRÖSSE	80 90E
FARBE	ANTHRAZIT (FKG), GOLDEICHE (FDE)
TÜRZARGE	PERFOTHERM
SCHWELLE	ALUMINIUMSCHWELLE
ARMATUREN	TÜRROSETTEN BLOCK TÜRDRÜCKER - TÜRDRÜCKER MIT SCHLIESSZYLINDERN

TÜRENMODELL	OPTIMA 60
GRÖSSE	80 90E
FARBE	ANTHRAZIT (FKG), GOLDEICHE (FDE)
TÜRZARGE	PERFOTHERM
SCHWELLE	ALUMINIUMSCHWELLE
ARMATUREN	TÜRROSETTEN BLOCK TÜRDRÜCKER - TÜRDRÜCKER MIT SCHLIESSZYLINDERN

* NUR IN DER GENANNTEN KONFIGURATION SIND DIE TÜREN SOFORT VERFÜGBAR. DIE TÜREN WERDEN AB LAGER ZUM SCHNELLSTMÖGLICHEN TERMIN GELIEFERT.



TÜREN

Unsere Lösungen für Türrahmen und Türblätter eignen sich ausgezeichnet – auch bei den anspruchsvollsten Objektanwendungen. Die von uns angebotenen Paneel- und Metalltüren kennzeichnen sich durch überdurchschnittliche Lebensdauer, Funktionalität (z. B. mit der Möglichkeit einer einfachen Demontage und eines Türpaneel-Austauschs) und Gestaltungsfreiheit.



SCHLÖSSER UND BESCHLÄGE

Sicherheit hat Priorität. Einen hohen Einbruchwiderstand erzielen wir durch innenliegende Gussteile bzw. thermisch behandelte Stahlplatten. Die gehärtete Steckzylinderblende bietet Schutz gegen Herausziehen und verhindert das Ausbohren.

Das Hauptschlüsselsystem MASTER KEY ist eine für Gewerbeobjekte bestimmte Lösung. Nur mit einem Schlüssel kann man eine bestimmte Anzahl von Verriegelungen öffnen. Dies gestattet eine einfache und schnelle Kommunikation in der Gewerbeeinheit und bietet Komfort bei der Zugriffsverwaltung zu den Zonen und Räumen.



TORE

Alle von uns angebotenen Garagentore entsprechen den europäischen Normen. GERDA-Tore sind ohne Aufpreis mit einem kompletten Sicherheitssystem ausgestattet.

Die Tore der Serie Trend sind eine wirtschaftliche, aber auch beständige und funktionelle Lösung, die sich für Bauträgerobjekte perfekt eignet.

Die Tore der Linie Classic garantieren eine sehr gute Wärmedämmung, unter anderem dank der Verwendung von warmen, 45 mm dicken Paneelen. Sie eignen sich perfekt für Gebäude mit hohen Anforderungen an die Energieeffizienz.



ALUMINIUMFENSTER UND -TÜREN

GERDA steht auch für Aluminiumfenster und -Türen. Wir bauen Trennwände, Türen, Fenster, Vitrinen und räumliche Innen- und Außenbauten, auch in feuer- und rauchfester Ausführung und mit erhöhter Einbruchssicherheit.

WAS SOLL MAN ÜBER GERDA-TÜREN WISSEN



WÄRMEISOLATION

Der Wärmedurchgangskoeffizient (U_d) gibt an, wie viel Wärmeenergie durch die Tür (einschließlich Türrahmen) dringt. Auf Basis dieses Koeffizienten können wir die Wärmeverluste separat für das jeweilige Trennelement bestimmen. Auch ein geringer Wärmeverlust führt zu höheren Rechnungsbeträgen für die Heizung. Der Wert dieses Koeffizienten hängt von der Art und der Stärke des Materials ab, aus welchem die Tür gefertigt ist. Durch den Einsatz moderner Technik und Stahl-Holz- sowie Aluminium-Türrahmen erfüllen die Gerda-Außentüren die derzeit geltenden Normen.

Die Gerda-Türen können je nach den eingesetzten Komponenten unterschiedliche Werte der Dämmungskoeffizienten erreichen:

- gedämmte Türen
- energieeffiziente Türen
- Passivtüren

Die Basistüren im Angebot der gedämmten Türen kennzeichnen sich durch einen Koeffizienten unter $1,3 \text{ W/m}^2\text{K}$. Zum Einsatz kommen hierbei der Stahltürrahmen PERFOOTHERM® mit Thermoperforation, Dichtung und Schwelle. Die energieeffizienten Türen Optima 60 und Thermo Premium 60 haben einen Koeffizienten ab dem Wert von $0,9$

$\text{W/m}^2\text{K}$ beim Einsatz eines wärmeisolierten Aluminiumtürrahmens ALUTHERM (mit Füllung der Thermokammer und mit Dichtung) sowie $1,0 \text{ W/m}^2\text{K}$ beim Einsatz des Türrahmens DUOTHERM (eines wärmeisolierten Stahl-Holz-Türrahmens mit Thermoperforation und mit Dichtung).

Passivtüren sind Türen, mit denen vor allem eine maximale Energieeinsparung in Kombination mit der Steigerung des Wohnkomforts erzielt werden soll. Sie ermöglichen das Zurückhalten der Energie im Innenraum, was sich in Direkteinsparungen zeigt. Die Thermo Premium 75 Türen kennzeichnen sich durch einen Wärmedurchgangskoeffizienten mit Werten ab $0,79 \text{ W/m}^2\text{K}$. Der Wärmedurchgangskoeffizient gilt für Volltüren beim Einsatz eines wärmeisolierten Aluminiumtürrahmens ALUTHERM.



OHNE ISOLATION

$1,5 \text{ W/m}^2\text{K}$

$1,3 \text{ W/m}^2\text{K}$
REINE LUFT

$1,0 \text{ W/m}^2\text{K}$

EINBRUCHWIDERSTAND

Dies ist ein Parameter, der für einbruchhemmende Türen verwendet wird. Solche Türen haben eine spezielle robuste Bauweise, die unter anderem Aufbohrversuche erheblich erschweren und somit unbefugtes Eindringen verhindern soll. Die GERDA-Türen sind standardmäßig mit zwei robusten Schlössern mit Mehrpunktverriegelung ausgestattet. Eine wichtige Komponente sind die Aufbohrschutzbolzen, die ein Aushängen des Türrahmens oder Aufstemmen auf der Bandseite verhindern sollen. Die GERDA-Türen werden Prüfungen der Widerstandsfähigkeit gegen Einbruch unterzogen und haben eine Einbruchhemmungs-Widerstandsklasse von RC2/RC3 bis RC3. Der Einsatz einer Tür einer höheren Widerstandsklasse erhöht die Sicherheit von Menschen und Sachwerten im Haus.



EINBRUCHSICHERHEITSKLASSEN

WIDERSTANDSKLASSE RC2

- ZANGE
- KEIL
- HAMMER

WIDERSTANDSKLASSE RC3

- BRECHSTANGE AUS STAHL
- KEIL
- HAMMER
- MECHANISCHE BOHRMASCHINE

WIDERSTANDSKLASSE RC4

- SCHWERER HAMMER
- AXT
- BRECHER
- MEISSEL
- BOHRMASCHINE

1

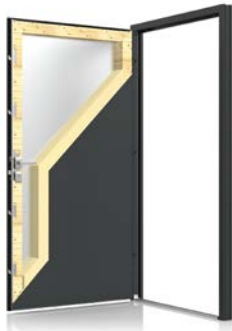

**WAS SOLL MAN BEI DER AUSWAHL
DER GERDA-TÜREN BEACHTEN**

2



**ENTSCHEIDEN SIE, WELCHE BAUWEISE
AM BESTEN IHREN ANFORDERUNGEN
GERECHT WIRD**

3

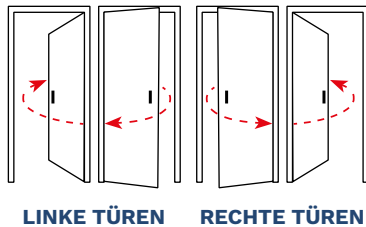

**ÜBERPRÜFEN SIE DIE ERHÄLTlichen
BREITEN UND ENTSCHEIDEN SIE SICH**

4



**GENIESSEN SIE DIE MÖGLICHKEIT
EINER INDIVIDUELLEN PLANUNG,
INDEM SIE DAS DESIGN
DER TÜROBERFLÄCHE UND
DAS APPLIKATIONSMUSTER AUSWÄHLEN**

5



**WÄHLEN SIE OPTIONAL ZUSÄTZLICHES
ZUBEHÖR: SEITENLICHTER,
TÜRDRÜCKER, GRIFFE, TÜRRAHMEN**

KOLLEKTION DER GERDA-TÜREN

GERDA®

PRODUKT DER KLASSE PREMIUM



**MILANO 8
WINCHESTER**

**VILLACH
STAHLGRAU**

**INNSBRUCK
NUSSBAUM HELL**

GERDA® KOLLEKTION DER GERDA-TÜREN

PRODUKT DER KLASSE PREMIUM



**REGEN 5
ANTHRACIT DUNKEL**



**BAMBERG 3
LIGHT WENGE**

GERDA **ERDA**[®] THERMO PRIME 75

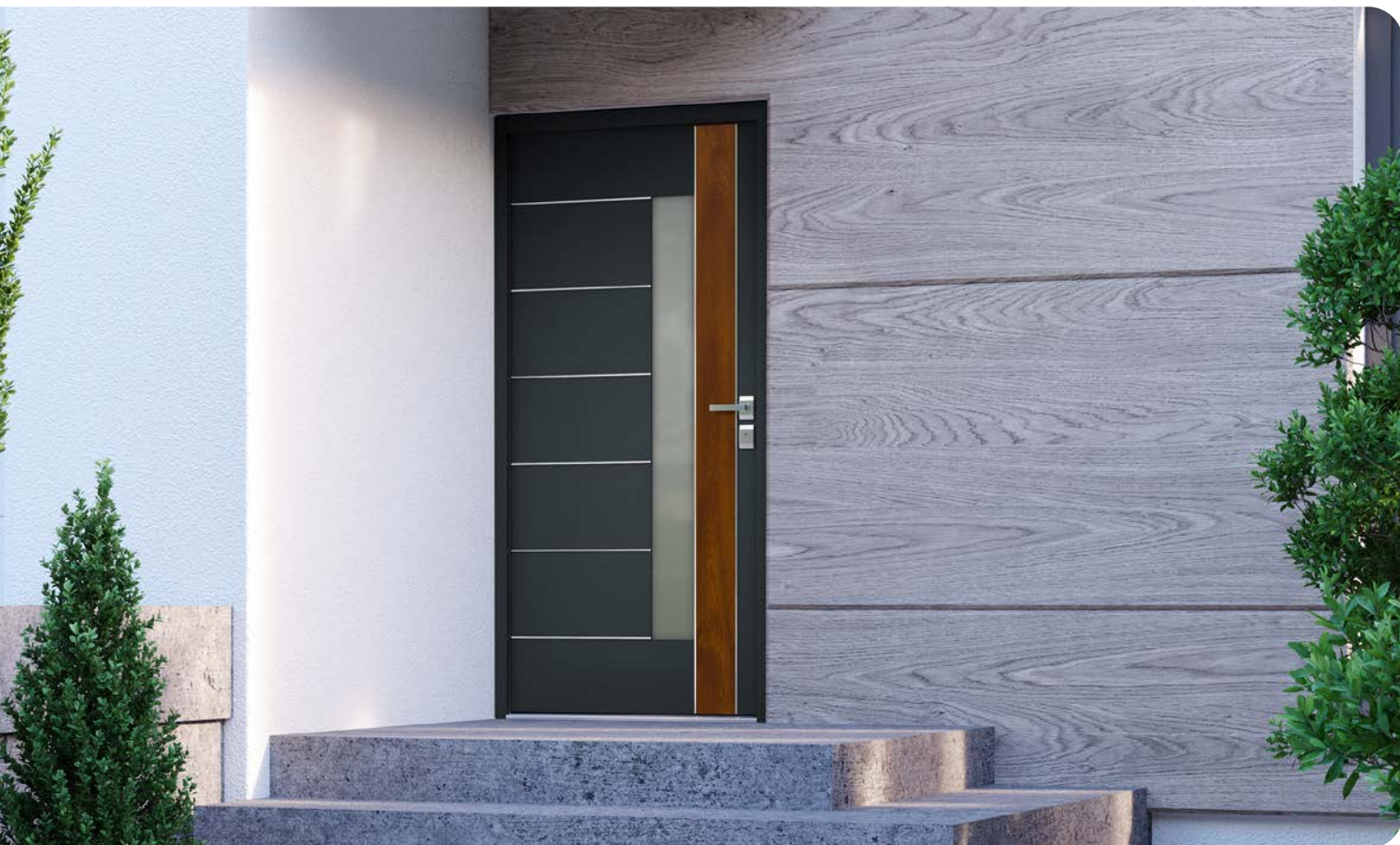

MERKMALE

	WÄRMEISOLATION	VOLLVERSION / VERGLASTE TÜRRAHMEN ALUTHERM PRIME 0,79 W/m²K / 0,9 W/m²K
	EINBRUCHSICHERHEITSKLASSE	RC2
	TÜRBLATTSTÄRKE	75 mm
	TÜRGRÖSSEN	80, 90N, 90E, 100E*
	DESIGNSERIEN	4
	TÜRBLATTKONSTRUKTION	TÜRRAHMEN AUS HOLZ + PUR-SCHAUMSTOFF
	NICHT-STANDARDGRÖSSEN DER TÜREN	HÖHERE TÜR GESAMTHÖHE BIS ZU 2400 MM

* AUFPREIS

**TÜREN IN VOLLVERSION / VERGLASTE
TÜRRAHMEN ALUTHERM PRIME**

UD = 0,79 / 0,9 W/m²K

**TÜREN IN VOLLVERSION / VERGLASTE
STAHL-TÜRRAHMEN**

-

RC2

TÜRRAHMEN ALUTHERM PRIME



VERSTELLBARE HAKENSTIFTE

Verstellbare Hakenstifte mit flexiblem Teflonzylinder



WÄRMEDÄMMEINLAGE



3D-BAND MIT BLENDE

Verstellbar in drei Ebenen, Blenden in der Farbe der Bänder



TÜRSTÄRKE



5-PUNKT-SCHLOSS IN SCHLISSLEISTE

Einbau des Schlosses in der gesamten Höhe des Türrahmens.

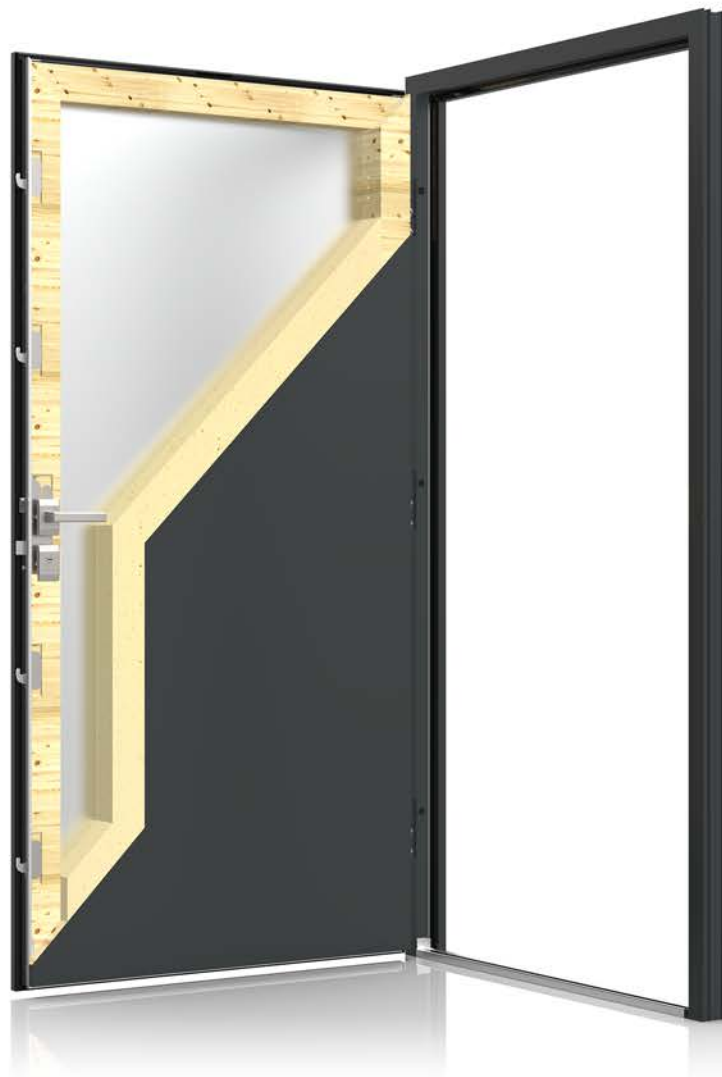

VERSTELLBARER HAKENSTIFT

Ermöglicht die stufenlose Einstellung des Andrucks des Türrahmens an die Dichtungen.



RINGFÖRMIGE TÜRROSETTE

Erhältlich im Set mit Griff



AUFBOHRSCHUTZBOLZEN

Fixe Aufbohrschutzbolzen in Metallkonsolen.



WÄRMEISOLIERTE ALUMINIUMSCHWELLE MIT VERBINDER



UNTERER FALZ, BÜRSTENDICHTUNG PRIME

TÜRRAHMEN ALUTHERM PRIME

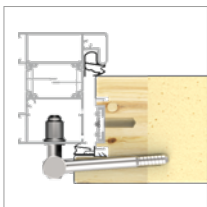

SCHWELLE

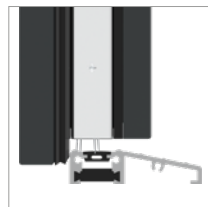

LEGENDE

* DER NETTO-PREIS UMFASST TÜRLATT, SCHWELLE, TÜRRAHMEN UND TÜRDRÜCKER MIT SCHLISSZYLINDER IN KLASSE 5 SOWIE MONTAGE-SET.





■ ■ AUFPREIS

GERDA THERMO PREMIUM 75

GERDA®



MERKMALE

	WÄRMEISOLATION	VOLLVERSION / VERGLASTE TÜRRAHMEN DUOTHERM 0,9 W/m²K / 1,3 W/m²K	VOLLVERSION / VERGLASTE TÜRRAHMEN ALUTHERM PREMIUM 0,8 W/m²K / 1,1 W/m²K
	EINBRUCHSICHERHEITSKLASSE		RC2 / RC3*
	TÜRBLATTSTÄRKE		75 mm
	TÜRGRÖSSEN		80, 90N, 90E, 100E**
	DESIGNSERIEN		4
	TÜRBLATTKONSTRUKTION	TÜRRAHMEN AUS HOLZ + GRAUES EPS	

* AUSSCHLISSLICH TÜREN IN VOLLVERSION, AUFPREIS
** AUFPREIS

**TÜREN IN VOLLVERSION / VERGLASTE
TÜRRAHMEN ALUTHERM PREMIUM**

UD = 0,8 / 1,1 W/m²K

**TÜREN IN VOLLVERSION / VERGLASTE
TÜRRAHMEN DUOTHERM**

UD = 0,9 / 1,3 W/m²K

RC2/RC3



VERTIKALE VERRIEGELUNG

Vertikale Einbruchschutz-
-Verriegelung, gesteuert über
das Hauptschloss – für RC3



WÄRMEDÄMMEINLAGE

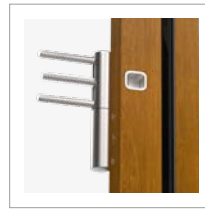

3D-BAND MIT BLENDEN

Verstellbar in drei Ebenen, Blenden
in der Farbe der Bänder



TÜRSTÄRKE



ZUSATZSCHLOSS

3-Punktverriegelung der Klasse 6
GERDA ZW 500



HAUPTSCHLOSS

Zentralschloss
3-Punktverriegelung der Klasse 7
GERDA ZW 2000



HILFSSCHLOSS

2-Punktverriegelung



**VERSTELLBARER
HAKENSTIFT**

Ermöglicht die stufenlose Einstellung
des Andrucks des Türrahmens
an die Dichtungen.

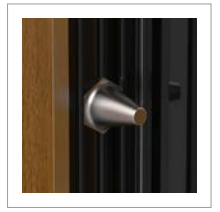

AUFBOHRSCHUTZBOLZEN

Fixed anti-prizing bolts
in metal supports.



**UNTERER FALZ,
BÜRSTENDICHTUNG**

**TÜRRAHMEN
ALUTHERM PREMIUM**

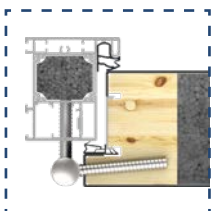

**TÜRRAHMEN
DUOTHERM**



SCHWELLE

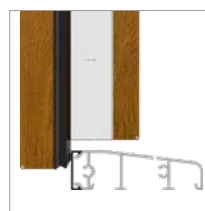

LEGENDE

* DER NETTO-PREIS
UMFASST TÜRBLATT,
SCHWELLE,
TÜRRAHMEN UND
TÜRDRÜCKER MIT
SCHLISSZYLINDER
IN KLASSE 5 SOWIE
MONTAGE-SET.

— AUFPREIS

GERDA THERMO PREMIUM 60 **ERDA**[®]



MERKMALE

UD	WÄRMEISOLATION	VOLLVERSION / VERGLASTE TÜRRAHMEN DUOTHERM 1,0 W/m²K / 1,3 W/m²K	VOLLVERSION / VERGLASTE TÜRRAHMEN ALUTHERM PREMIUM 0,9 W/m²K / 1,2 W/m²K
RC	EINBRUCHSICHERHEITSKLASSE		RC2 / RC3*
	TÜRBLATTSTÄRKE		60 mm
	TÜRGRÖSSEN		80, 90N, 90E, 100E*
	DESIGNSERIEN		4
	TÜRBLATTKONSTRUKTION	TÜRRAHMEN AUS HOLZ + GRAUES EPS	

* AUFPREIS

**TÜREN IN VOLLVERSION / VERGLASTE
TÜRRAHMEN ALUTHERM PREMIUM**

UD = 0,9 / 1,2 W/m²K

**TÜREN IN VOLLVERSION / VERGLASTE
TÜRRAHMEN DUOTHERM**

UD = 1,0 / 1,3 W/m²K

RC2/RC3



VERTIKALE VERRIEGELUNG

Anti-burglary vertical bolt controlled with the main lock for RC3

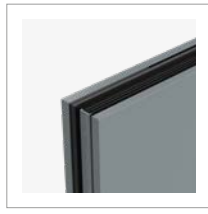

WÄRMEDÄMMEINLAGE



3D-BAND MIT BLENDEN

Verstellbar in drei Ebenen, Blenden in der Farbe der Bänder



TÜRSTÄRKE



ZUSATZSCHLOSS

3-Punktverriegelung der Klasse 6 GERDA ZW 500



HAUPTSCHLOSS

3-ryglowy klasy 7 GERDA ZW1000, dla RC3 zamek centralny ZW2000



HILFSSCHLOSS

2-Punktverriegelung for RC3

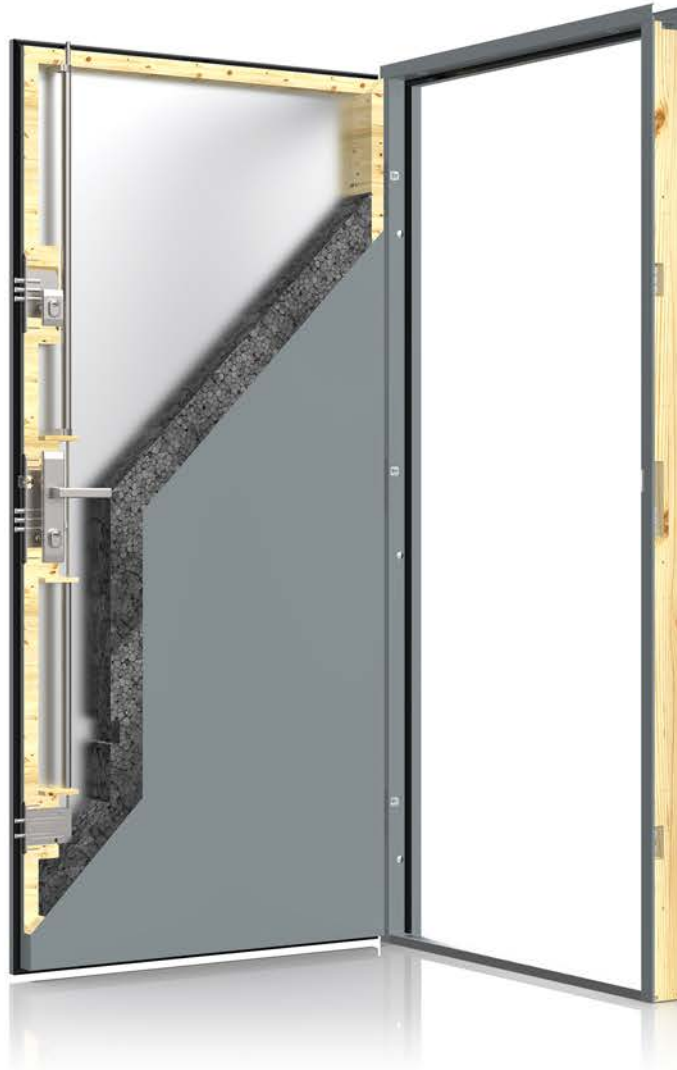

**VERSTELLBARER
HAKENSTIFT**

Ermöglicht die stufenlose Einstellung des Andrucks des Türrahmens an die Dichtungen.



AUFBOHRSCHUTZBOLZEN

Fixed anti-prizing bolts in metal supports.



**UNTERER FALZ,
BÜRSTENDICHTUNG**

**ALUTHERM PREMIUM
TÜRZARGE**



**DUOTHERM
TÜRZARGE**

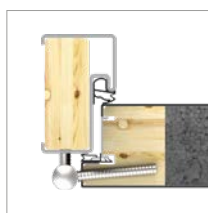

SCHWELLE

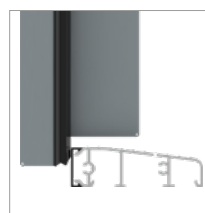

LEGENDE

* DER NETTO-PREIS UMFASST TÜRBLATT, SCHWELLE, TÜRRAHMEN UND TÜRDRÜCKER MIT SCHLIESSZYLINDER IN KLASSE 5 SOWIE MONTAGE-SET.

— AUFPREIS

AIR GLASS



AGB LINZ 1 S. 26



AGC LINZ 2 S. 26



AGD LINZ 3 S. 27



AGDB LINZ 3 B S. 27



AGE GRAZ 1 S. 28



AGF GRAZ 2 S. 28



AGG GRAZ 3 S. 29

QUADRO



KWA PASAWA 1 S. 32



KWB PASAWA 2 S. 32



KWC PASAWA 3 S. 33



KWD PASAWA 4 S. 33



KWE JENA 3 S. 34



KW4 JENA 4 S. 34



KWF BAMBERG 1 S. 36



KWN TREWIR 3 S. 41



KWP TREWIR 4 S. 41



KW7 TREWIR 7 S. 41



KWS DORFEN S. 42



KWT KASSEL 1 S. 44



KWX KASSEL 2 S. 44



KPN KRONACH 1 S. 46



KPM REGEN 5 S. 49



KPR REGEN 6 S. 49



KPRB REGEN 6 B S. 49



KPE DREZNO 1 S. 50



KPF DREZNO 2 S. 50



KPH DREZNO 4 S. 51



KPA ERFURT 1 S. 52

ELITE 3D



ELA BRIG S. 54



ELB OLTEN S. 54



ELC VISP S. 55



ELD TRIN S. 55



ELE BERNO S. 55

TEMPO



NS1 MILANO 8 S. 56



NS2 MILANO 9 S. 56



AGGB GRAZ 3 B S. 29



AGA SALZBURG S. 30



AGH VILLACH S. 30



AGHB VILLACH B S. 30



KWG BAMBERG 2 S. 36



KWH BAMBERG 3 S. 37



KWI BAMBERG 4 S. 37



KWJ ULM 1 S. 38

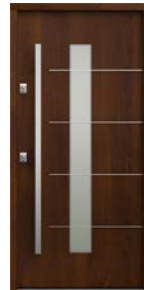

KWK ULM 2 S. 38



KWL TREWIR 1 S. 40



KWM TREWIR 2 S. 40



KPP KRONACH 2 S. 46



KPT KRONACH 3 S. 47



KPZ KRONACH 4 S. 47



KPJ REGEN 1 S. 48



KPK REGEN 2 S. 48



KPL REGEN 3 S. 49



KPS REGEN 4 S. 49



KPB ERFURT 2 S. 52



KPC ERFURT 3 S. 53



NS3 MILANO 10 S. 57



NS4 MILANO 11 S. 57



NS9B MILANO 12 B S. 57



NSSB HANOVER 5 B S. 58



NS6 HANOVER 6 S. 58



NS7 INNSBRUCK S. 59



W00 FLACH S. 60



MERKMALE

UD	WÄRMEISOLATION	VOLLVERSION / VERGLASTE TÜRRAHMEN PERFOTHERM 1,1 W/m ² K / 1,3 W/m ² K	VOLLVERSION / VERGLASTE TÜRRAHMEN ALUTHERM PREMIUM 1,0 W/m ² K / 1,3 W/m ² K
RC	EINBRUCHSICHERHEITSKLASSE		RC2 / RC3*
	TÜRBLATTSTÄRKE		60 mm
	TÜRGRÖSSEN		80N, 80, 90N, 90E, 100E**
	DESIGNSERIEN		2
	TÜRBLATTKONSTRUKTION	HOLZBLÖCKE + TÜRRAHMEN AUS HOLZ + GRAUES EPS	

* AUSSCHLIESSLICH TÜREN IN VOLLVERSION, AUFPREIS
** AUFPREIS

**TÜREN IN VOLLVERSION / VERGLASTE
TÜRRAHMEN ALUTHERM PREMIUM**

UD = 1,0 / - W/m²K

**TÜREN IN VOLLVERSION / VERGLASTE
TÜRRAHMEN DUOTHERM**

UD = 1,1 / 1,3 W/m²K

RC2/RC3



VERTIKALE VERRIEGELUNG

Anti-burglary vertical bolt controlled with the main lock for RC3

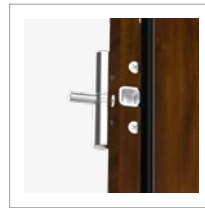

2D-BAND MIT BLENDEN

Bleenden in der Farbe der Bänder



TÜRSTÄRKE

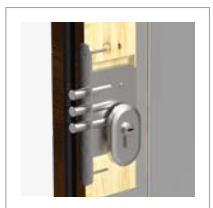

ZUSATZSCHLOSS

3-Punktverriegelung der Klasse 6
GERDA ZW 500

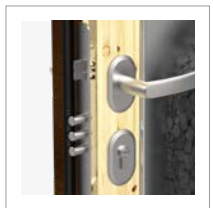

HAUPTSCHLOSS

3-Punktverriegelung der Klasse 7
GERDA ZWI000, für RC3
Zentralschloss ZW2000



HILFSSCHLOSS

2-Punktverriegelung for RC3



**VERSTELLBARER
HAKENSTIFT**

Ermöglicht die stufenlose Einstellung
des Andrucks des Türrahmens
an die Dichtungen.



AUFBOHRSCHUTZBOLZEN

Fixed anti-prizing bolts
in metal supports.



**ALUTHERM OPTIMA
TÜRZARGE**

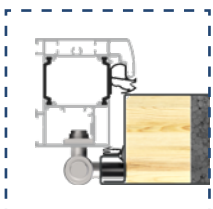

**PERFOTHERM
TÜRZARGE**



SCHWELLE





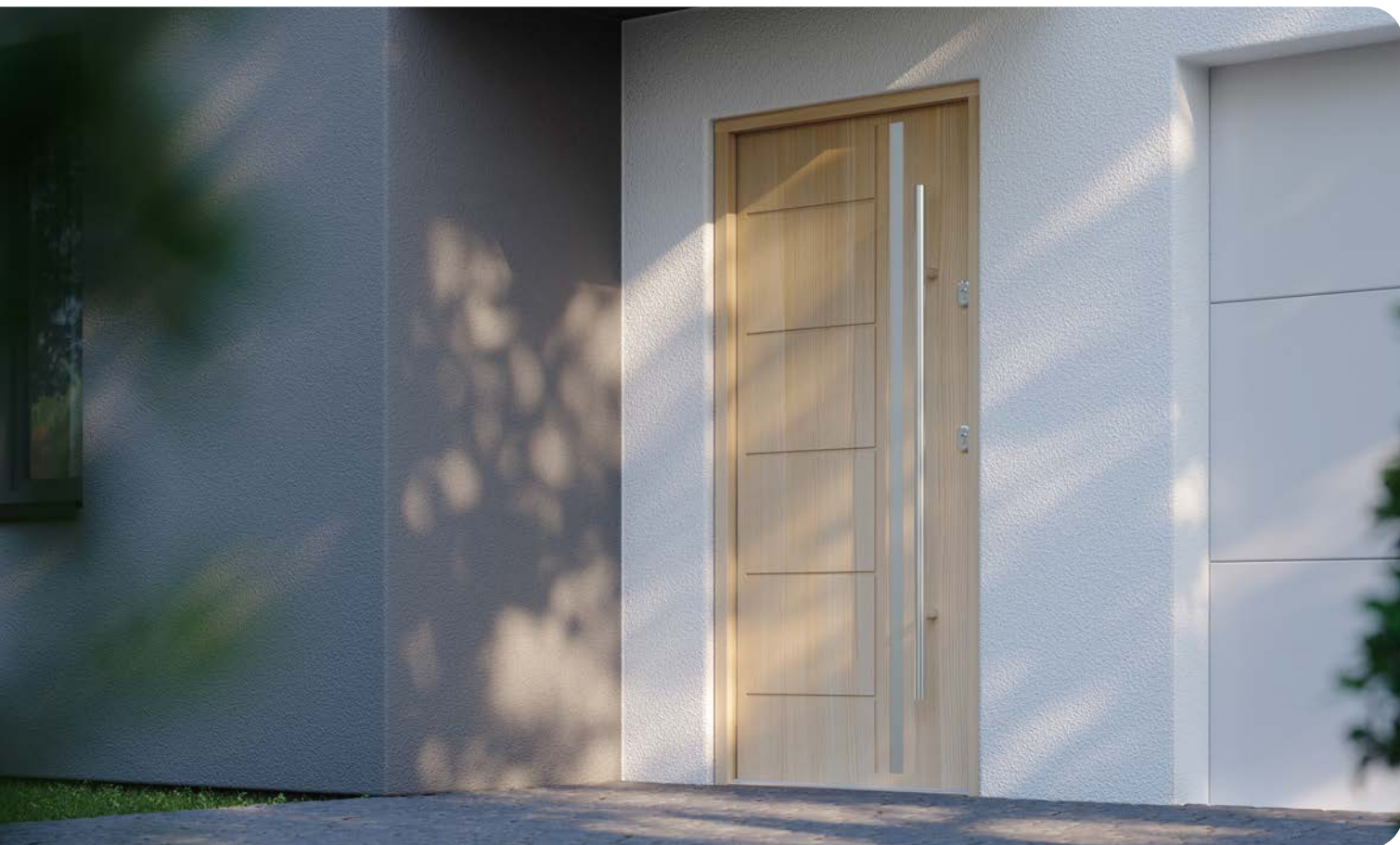

LEGENDE

* DER NETTO-PREIS
UMFASST TÜRLATT,
SCHWELLE,
TÜRRAHMEN UND
TÜRDRÜCKER MIT
SCHLIESSZYLINDER
IN KLASSE 5 SOWIE
MONTAGE-SET.

— AUFPREIS



MERKMALE

	WÄRMEISOLATION	VOLLVERSION TÜRRAHMEN PERFOTHERM 1,2 W/m²K
	EINBRUCHSICHERHEITSKLASSE	RC2
	TÜRBLATTSTÄRKE	50 mm
	TÜRGRÖSSEN	80N, 80, 90N, 90E, 100E*
	DESIGNSERIEN	2
	TÜRBLATTKONSTRUKTION	HOLZBLÖCKE + TÜRRAHMEN AUS HOLZ + GRAUES EPS

* AUFPREIS

**TÜREN IN VOLLVERSION / VERGLASTE
TÜRRAHMEN ALUMINIUM**

-

**TÜREN IN VOLLVERSION
TÜRRAHMEN PERFOTHERM**

UD = 1,2 W/m²K

RC2



2D-BAND MIT BLENDEN
Blenden in der Farbe der Bänder



TÜRSTÄRKE

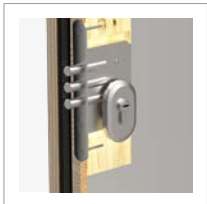

ZUSATZSCHLOSS
3-Punktverriegelung der Klasse 6
GERDA ZW 500

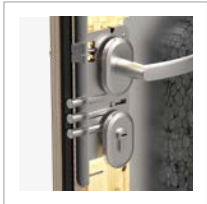

HAUPTSCHLOSS
3-bolt class 7
GERDA ZW 1000



**VERSTELLBARER
HAKENSTIFT**
Ermöglicht die stufenlose Einstellung
des Andrucks des Türrahmens
an die Dichtungen.



AUFBOHRSCHUTZBOLZEN
Fixed anti-prizing bolts
in metal supports.

**PERFOTHERM
TÜRZARGE**

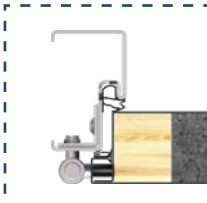

* COMPATIBLE WITH WOODEN SILLS

**FB
TÜRZARGE**



**FN
TÜRZARGE**



SCHWELLE



LEGENDE

* DER NETTO-PREIS
UMFASST TÜRLATT,
SCHWELLE,
TÜRRAHMEN UND
TÜRDRÜCKER MIT
SCHLISSZYLINDER
IN KLASSE 5 SOWIE
MONTAGE-SET.
— AUFPREIS

TEMPO



NS1 MILANO 8 S. 56



NS2 MILANO 9 S. 56



NS3 MILANO 10 S. 57



NS4 MILANO 11 S. 57



NS9 MILANO 12 S. 57



NS9B MILANO 12 B S. 57



NS5 HANOVER 5 S. 58



NT1 TURYN 1 S. 64



NT2 TURYN 2 S. 65



SOJ BERGAMO 2 S. 66



SJ9 NICEA 9 S. 66



SBE BERLIN 4 S. 67



ST4 UPPSALA 1 S. 68



ST4A UPPSALA 1A S. 68



ST9 LUND S. 72



WBA ASPEN 1 S. 73



TN7 ASPEN 2 S. 73



TN7B ASPEN 2B S. 73



SR3 TROMSO S. 74



SR4 TROMSO 1 S. 74



SR5 TROMSO 2 S. 75

CLASSIC



W76 MODENA S. 76



W77 MODENA 2 S. 76



W78 MODENA 3 S. 77



WDR RAVENA S. 77



WJ1 NICEA 5 S. 78



W23 OLYMPIA S. 79



W91 WERONA S. 80



W24 LIZBONA s. 82



W9N WENECJA s. 82



W13 LONDYN s. 83



W5L LONDYN 1 s. 83



W54 BARCELONA s. 84



W53 BARCELONA 1 s. 84



G76 GENEWA 1 s. 85



NS5B HANOVER 5 B S. 58



NS6 HANOVER 6 S. 58



NS7 INNSBRUCK S. 59



W00 FLACH S. 60



W00 FLACH S. 60



SNU MILANO 4 S. 62



SNUA MILANO 4A S. 62



ST5 UPPSALA 2 S. 69



ST5A UPPSALA 2A S. 69



TML TOKIO 1 S. 70



TMLA TOKIO 1A S. 70



TMM TOKIO 2 S. 71



TMMa TOKIO 2A S. 71



ST8 RYGA S. 72



SR5 TROMSO 2 S. 75



W94 WERONA 1 S. 80



W93 WERONA 3 S. 81



W6A WERONA 4 S. 81



WQA WERONA 5 S. 81



G75 GENEWA 2 s. 85



D75 GENEWA 3 s. 85



AGB LINZ 1



AGC LINZ 2

GRÖSSE	80	90N	90E	100E
--------	----	-----	-----	------

MODEL	THERMO PREMIUM 60	THERMO PREMIUM 75	THERMO PRIME 75
AGB / AGBB LINZ 1	✓	✓	✓
AGC / AGCB LINZ 2	✓	✓	✓
AGD / AGDB LINZ 3	✓	✓	✓

STANDARDAUSSTATTUNG RC2

- TÜRBLATT VERGLAST, ERFÜLLT DIE BEDINGUNGEN DES PROGRAMMS „REINE LUFT“
- 4 TÜRBLATT-FALZE
- THERMO PREMIUM TÜRRAHMEN DUOTHERM / THERMO PRIME TÜRRAHMEN ALUTHERM PRIME
- VERSTELLBARE 3D-BÄNDER MIT BLENCEN IN DER FARBE DER BÄNDER
- WÄRMEISOLIERTE SCHWELLE
- BESCHLÄGE-SET MIT SCHLIESSZYLINDER-SCHUTZ
- TÜRROSETTEN BERGEN MIT TÜRDRÜCKERN ALEX
- SCHLIESSZYLINDER IN KLASSE 5, EIN-SCHLÜSSEL-SYSTEM FÜR TÜREN THERMO PREMIUM

• INSERTS **INOX** **SCHWARZ**

AUFPREISE

TÜRRAHMEN ALUTHERM PREMIUM (TÜREN THERMO PREMIUM)	✓	GRIFF AMSTERDAM / MONTREAL 1500 mm, EMPFOHLENE ELEKTROVERRIEGELUNG	✓
MASSE 100E	✓	GRIFF AMSTERDAM / MONTREAL 1000 mm, EMPFOHLENE ELEKTROVERRIEGELUNG	✓
TÜREN IN ZWEIFARBIGER AUSFÜHRUNG	✓	GRIFF MIT DRÜCKER AMSTERDAM / MONTREAL 1500 mm MIT TÜRBLATTANPASSUNG, ERFORDERLICHE ELEKTROVERRIEGELUNG	✓
SCHLIESSZYLINDER IN KLASSE 6 IM 1-SCHLÜSSEL-SYSTEM	✓	GRIFF MIT DRÜCKER AMSTERDAM / MONTREAL 1000 mm MIT TÜRBLATTANPASSUNG, ERFORDERLICHE ELEKTROVERRIEGELUNG	✓
SCHUTZ DER OBEREN TÜRROSETTE (THERMO PREMIUM)	✓	ELEKTROVERRIEGELUNG MIT TAG-/NACHT-FUNKTION	✓
TÜRDRÜCKER/TÜRKNAUF	✓	REED-RELAIS SET TEDEE	✓

* FIXE ALUMINIUM-SEITENLICHTER AUF SEITE 88-89, VOLLSTÄNDIGE LISTE MIT ZUBEHÖRTEILEN AUF SEITE 94-99

SCHEIBEN



GRAFIT

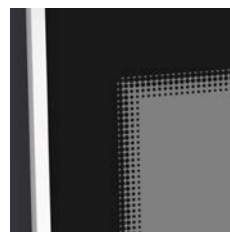

INOX



SCHWARZ

FARBEN DER TÜREN

ALPINE NUSSBAUM



FRR

MAHAGONI



FMA

BRAZILIAN NUSSBAUM



FRB

NUSSBAUM HELL



FRP

GOLDEICHE



FDE

WINCHESTER



FDW

LIGHT WENGE



FEJ

WEISS



FSB

STAHLGRAU



FKZ

ANTHRAZIT



FKG

ANTHRAZIT DUNKEL



FKF

SCHWARZ



FKC



AGD LINZ 3



INNENSEITE

KONFIGURATION DER TÜR THERMO PRIME 75



AGDB LINZ 3 B



INNENSEITE

TÜR BESCHLÄGE

TÜRDRÜCKER-
TÜRDRÜCKER



THERMO PRIME



THERMO PREMIUM

TÜRDRÜCKER-
TÜRKNÄUF



THERMO PRIME



THERMO PREMIUM

GRIFF



□ AMSTERDAM
○ MONTREAL

FARBEN
DER BESCHLÄGE

ANODISIERSCHICHT
PLATINFARBEN



ANODISIERSCHICHT
SILBERN



ANODISIERSCHICHT
SCHWARZ



FARBEN DER TÜREN

ALPINE NUSSBAUM



MAHAGONI



BRAZILIAN NUSSBAUM



NUSSBAUM HELL



GOLDEICHE



WINCHESTER



LIGHT WENGE



WEISS



STAHLGRAU



ANTHRAZIT



ANTHRAZIT DUNKEL



SCHWARZ





AGE GRAZ 1



AGF GRAZ 2

GRÖSSE	80	90N	90E	100E
--------	----	-----	-----	------

MODEL	THERMO PREMIUM 60	THERMO PREMIUM 75	THERMO PRIME 75
AGE / AGEB GRAZ 1	✓	✓	✓
AGF / AGFB GRAZ 2	✓	✓	✓
AGG / AGGB GRAZ 3	✓	✓	✓

STANDARD AUSSTATTUNG RC2

- TÜRBLATT VERGLAST, ERFÜLLT DIE BEDINGUNGEN DES PROGRAMMS „REINE LUFT“
- 4 TÜRBLATT-FALZE
- THERMO PREMIUM TÜRRAHMEN DUOTHERM / THERMO PRIME TÜRRAHMEN ALUTHERM PRIME
- VERSTELLBARE 3D-BÄNDER MIT BLENDEN IN DER FARBE DER BÄNDER
- WÄRMEISOLIERTE SCHWELLE
- BESCHLÄGE-SET MIT SCHLIESSZYLINDER-SCHUTZ
- TÜRROSETTEN BERGEN MIT TÜRDRÜCKERN ALEX
- SCHLIESSZYLINDER IN KLASSE 5, EIN-SCHLÜSSEL-SYSTEM FÜR TÜREN THERMO PREMIUM

INSERTS **INOX** **SCHWARZ**

AUFPREISS

TÜRRAHMEN ALUTHERM PREMIUM (TÜREN THERMO PREMIUM)	✓	GRIFF AMSTERDAM / MONTREAL 1500 mm, EMPFOHLENE ELEKTROVERRIEGELUNG	✓
MASSE 100E	✓	GRIFF AMSTERDAM / MONTREAL 1000 mm, EMPFOHLENE ELEKTROVERRIEGELUNG	✓
TÜREN IN ZWEIFARBIGER AUSFÜHRUNG	✓	GRIFF MIT DRÜCKER AMSTERDAM / MONTREAL 1500 mm MIT TÜRBLATTANPASSUNG, ERFORDERLICHE ELEKTROVERRIEGELUNG	✓
SCHLIESSZYLINDER IN KLASSE 6 IM 1-SCHLÜSSEL-SYSTEM	✓	GRIFF MIT DRÜCKER AMSTERDAM / MONTREAL 1000 mm MIT TÜRBLATTANPASSUNG, ERFORDERLICHE ELEKTROVERRIEGELUNG	✓
SCHUTZ DER OBEREN TÜRROSETTE (THERMO PREMIUM)	✓	ELEKTROVERRIEGELUNG MIT TAG-/NACHT-FUNKTION	✓
TÜRDRÜCKER/TÜRKNAUF	✓	REED-RELAIS SET TEDEE	✓

* FIXE ALUMINIUM-SEITENLICHTER AUF SEITE 88-89, VOLLSTÄNDIGE LISTE MIT ZUBEHÖRTEILEN AUF SEITE 94-99

SCHEIBEN



GRAFIT

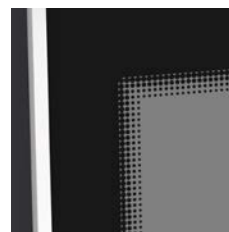

INOX



SCHWARZ

FARBEN DER TÜREN

ALPINE NUSSBAUM



FRR

MAHAGONI



FMA

BRAZILIAN NUSSBAUM



FRB

NUSSBAUM HELL



FRP

GOLDEICHE



FDE

WINCHESTER



FDW

LIGHT WENGE



FEJ

WEISS



FSB

STAHLGRAU



FKZ

ANTHRAZIT



FKG

ANTHRAZIT DUNKEL



FKF

SCHWARZ



FKC



AGGB GRAZ 3 B



INNENSEITE

KONFIGURATION DER TÜR THERMO PRIME 75



AGF GRAZ 2



INNENSEITE

TÜR BESCHLÄGE

TÜRDRÜCKER-
TÜRDRÜCKER



THERMO PRIME



THERMO PREMIUM

TÜRDRÜCKER-
TÜRKNÄUF



THERMO PRIME



THERMO PREMIUM

GRIFF



□ AMSTERDAM
○ MONTREAL

FARBEN
DER BESCHLÄGE

ANODISIERSCHEIT
PLATINFARBEN



ANODISIERSCHEIT
SILBERN



ANODISIERSCHEIT
SCHWARZ



FARBEN DER TÜREN

ALPINE NUSSBAUM



FRR

MAHAGONI



FMA

BRAZILIAN NUSSBAUM



FRB

NUSSBAUM HELL



FRP

GOLDEICHE



FDE

WINCHESTER



FDW

LIGHT WENGE



FEJ

WEISS



FSB

STAHLGRAU



FKZ

ANTHRAZIT



FKG

ANTHRAZIT DUNKEL



FKF

SCHWARZ



FKC

AIR GLASS SALZBURG / VILLACH



AGA SALZBURG



AGHB VILLACH B

GRÖSSE (AGA SALZBURG)	80	90N	90E	100E
GRÖSSE (AGH VILLACH)	-	-	90E	100E

MODEL	THERMO PREMIUM 60	THERMO PREMIUM 75	THERMO PRIME 75
AGA / AGAB SALZBURG	✓	✓	✓
AGH / AGHB VILLACH	✓	✓	✓

STANDARD AUSSTATTUNG RC2

- TÜRBLATT VERGLAST, ERFÜLLT DIE BEDINGUNGEN DES PROGRAMMS „REINE LUFT“
- 4 TÜRBLATT-FALZE
- THERMO PREMIUM TÜRRAHMEN DUOTHERM / THERMO PRIME TÜRRAHMEN ALUTHERM PRIME
- VERSTELLBARE 3D-BÄNDER MIT BLENDEN IN DER FARBE DER BÄNDER
- WÄRMEISOLIERTE SCHWELLE
- BESCHLÄGE-SET MIT SCHLIESSZYLINDER-SCHUTZ
- TÜRROSETTEN BERGEN MIT TÜRDRÜCKERN ALEX
- SCHLIESSZYLINDER IN KLASSE 5, EIN-SCHLÜSSEL-SYSTEM FÜR TÜREN THERMO PREMIUM

• INSERTS **INOX** **SCHWARZ**

AUFPREISS

SONDERHÖHE (THERMO PRIME)	2150 - 2200 mm	✓
NUR AUSFÜHRUNG AGH / AGHB	2250 - 2300 mm	✓
VERFÜGBARE FARBEN: FRP, FDE, FDW, FKG, FKF	2350 - 2400 mm	✓
TÜRRAHMEN ALUTHERM PREMIUM (TÜREN THERMO PREMIUM)	✓ GRIFF AMSTERDAM / MONTREAL 1500 mm, EMPFOHLENE ELEKTROVERRIEGLUNG	✓
MASSE 100E	✓ GRIFF AMSTERDAM / MONTREAL 1000 mm, EMPFOHLENE ELEKTROVERRIEGLUNG	✓
TÜREN IN ZWEIFARBIGER AUSFÜHRUNG	✓ GRIFF MIT DRÜCKER AMSTERDAM / MONTREAL 1500 mm MIT TÜRBLATTANPASSUNG, ERFORDERLICHE ELEKTROVERRIEGLUNG	✓
SCHLIESSZYLINDER IN KLASSE 6 IM 1-SCHLÜSSEL-SYSTEM	✓ GRIFF MIT DRÜCKER AMSTERDAM / MONTREAL 1000 mm MIT TÜRBLATTANPASSUNG, ERFORDERLICHE ELEKTROVERRIEGLUNG	✓
SCHUTZ DER OBEREN TÜRROSETTE (THERMO PREMIUM)	✓ ELEKTROVERRIEGLUNG MIT TAG-/NACHT-FUNKTION	✓
TÜRDRÜCKER/TÜRKNÄUF	✓ REED-RELAIS	✓
	SET TEDEE	✓

* FIXE ALUMINIUM-SEITENLICHTER AUF SEITE 88-89, VOLLSTÄNDIGE LISTE MIT ZUBEHÖRTEILEN AUF SEITE 94-99

SCHEIBEN



GRAFIT

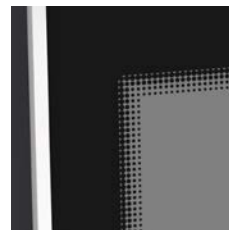

INOX



SCHWARZ

FARBEN DER TÜREN

ALPINE NUSSBAUM



FRR

MAHAGONI



FMA

BRAZILIAN NUSSBAUM



FRB

NUSSBAUM HELL



FRP

GOLDEICHE



FDE

WINCHESTER



FDW

LIGHT WENGE



FEJ

WEISS



FSB

STAHLGRAU



FKZ

ANTHRAZIT



FKG

ANTHRAZIT DUNKEL



FKF

SCHWARZ



FKC



AGA SALZBURG

KONFIGURATION DER TÜR THERMO PRIME 75



INNENSEITE

INNENSEITE

TÜRBSCHLÄGE

TÜRDRÜCKER-
-TÜRDRÜCKER



THERMO PRIME



THERMO PREMIUM

TÜRDRÜCKER-
-TÜRKNÄUF



THERMO PRIME



THERMO PREMIUM

GRIFF



- AMSTERDAM
- MONTREAL

FARBEN
DER BESCHLÄGE

ANODISIERSCHICHT
PLATINFARBEN



ANODISIERSCHICHT
SILBERN



ANODISIERSCHICHT
SCHWARZ



FARBEN DER TÜREN

ALPINE NUSSBAUM



FRR

MAHAGONI



FMA

BRAZILIAN NUSSBAUM



FRB

NUSSBAUM HELL



FRP

GOLDEICHE



FDE

WINCHESTER



FDW

LIGHT WENGE



FEJ

WEISS



FSB

STAHLGRAU



FKZ

ANTHRAZIT



FKG

ANTHRAZIT DUNKEL



FKF

SCHWARZ



FKC



KWA PASAWA 1



KWB PASAWA 2

GRÖSSE	80	90N	90E	100E
--------	----	-----	-----	------

MODEL	THERMO PREMIUM 60	THERMO PREMIUM 75	THERMO PRIME 75
KWA / KWAB PASAWA 1	✓	✓	✓
KWB / KWBB PASAWA 2	✓	✓	✓
KWC / KWCB PASAWA 3	✓	✓	✓
KWD / KWDB PASAWA 4	✓	✓	✓

STANDARD AUSSTATTUNG RC2

- TÜRLATT VERGLAST, ERFÜLLT DIE BEDINGUNGEN DES PROGRAMMS „REINE LUFT“
- 4 TÜRLATT-FALZE
- THERMO PREMIUM TÜRRAHMEN DUOTHERM / THERMO PRIME TÜRRAHMEN ALUTHERM PRIME
- VERSTELLBARE 3D-BÄNDER MIT BLENCEN IN DER FARBE DER BÄNDER
- WÄRMEISOLIERTE SCHWELLE
- BESCHLÄGE-SET MIT SCHLIESSZYLINDER-SCHUTZ
- TÜRROSETTEN BERGEN MIT TÜRDRÜCKERN ALEX
- SCHLIESSZYLINDER IN KLASSE 5, EIN-SCHLÜSSEL-SYSTEM FÜR TÜREN THERMO PREMIUM

• INSERTS **INOX** **SCHWARZ**

AUFPREISS

SONDERHÖHE (THERMO PRIME)	2150 - 2200 mm	✓
VERFÜGBARE FARBEN: FRP, FDE, FDW, FKG, FKF	2250 - 2300 mm	✓
	2350 - 2400 mm	✓
TÜRRAHMEN ALUTHERM PREMIUM (TÜREN THERMO PREMIUM)	✓ GRIFF AMSTERDAM / MONTREAL 1500 mm, EMPFOHLENE ELEKTROVERRIEGELUNG	✓
MASSE 100E	✓ GRIFF AMSTERDAM / MONTREAL 1000 mm, EMPFOHLENE ELEKTROVERRIEGELUNG	✓
VERKÜRZUNG DER TÜREN KWA, KWB, KWC (10, 20, 30, 40 mm), KWD (10, 20, 30, 40, 60, 80, 100 mm)	✓ GRIFF MIT DRÜCKER AMSTERDAM / MONTREAL 1500 mm MIT TÜRLATTANPASSUNG, ERFORDERLICHE ELEKTROVERRIEGELUNG	✓
TÜREN IN ZWEIFARBIGER AUSFÜHRUNG	✓ GRIFF MIT DRÜCKER AMSTERDAM / MONTREAL 1000 mm MIT TÜRLATTANPASSUNG, ERFORDERLICHE ELEKTROVERRIEGELUNG	✓
SCHLIESSZYLINDER IN KLASSE 6 IM 1-SCHLÜSSEL-SYSTEM	✓ ELEKTROVERRIEGELUNG MIT TAG-/NACHT-FUNKTION	✓
SCHUTZ DER OBEREN TÜRROSETTE (THERMO PREMIUM)	✓ REED-RELAIS	✓
TÜRDRÜCKER/TÜRKNAUF	✓ SET TEDEE	✓

* FIXE ALUMINIUM-SEITENLICHTER AUF SEITE 88-89, VOLLSTÄNDIGE LISTE MIT ZUBEHÖRTEILEN AUF SEITE 94-99

SCHEIBEN



MATT



MIRA STAR (SPIEGELGLAS)

FARBEN DER TÜREN

ALPINE NUSSBAUM



FRR

MAHAGONI



FMA

BRAZILIAN NUSSBAUM



FRB

NUSSBAUM HELL



FRP

GOLDEICHE



FDE

WINCHESTER



FDW

LIGHT WENGE



FEJ

WEISS



FSB

STAHLGRAU



FKZ

ANTHRAZIT



FKG

ANTHRAZIT DUNKEL



FKF

SCHWARZ



FKC



KWCB PASAWA 3 B



KWD PASAWA 4



INNENSEITE

KONFIGURATION DER TÜR THERMO PRIME 75



KWA PASAWA 1



INNENSEITE

TÜR BESCHLÄGE

TÜRDRÜCKER-
TÜRDRÜCKER



THERMO PRIME



THERMO PREMIUM

TÜRDRÜCKER-
TÜRKNAUFL



THERMO PRIME



THERMO PREMIUM

GRIFF



□ AMSTERDAM
○ MONTREAL

FARBEN
DER BESCHLÄGE

ANODISIERSCHICHT
PLATINFARBEN



ANODISIERSCHICHT
SILBERN



ANODISIERSCHICHT
SCHWARZ



FARBEN DER TÜREN

ALPINE NUSSBAUM



MAHAGONI



BRAZILIAN NUSSBAUM



NUSSBAUM HELL



GOLDEICHE



WINCHESTER



LIGHT WENGE



WEISS



STAHLGRAU



ANTHRAZIT



ANTHRAZIT DUNKEL



SCHWARZ





KW3 JENA 3



KW4 JENA 4

GRÖSSE	80	90N	90E	100E
--------	----	-----	-----	------

MODEL	THERMO PREMIUM 60	THERMO PREMIUM 75	THERMO PRIME 75
KW3 / KW3B JENA 3	✓	✓	✓
KW4 / KW4B JENA 4	✓	✓	✓

STANDARD AUSSTATTUNG RC2

- TÜRLATT VERGLAST, ERFÜLLT DIE BEDINGUNGEN DES PROGRAMMS „REINE LUFT“
- 4 TÜRLATT-FALZE
- THERMO PREMIUM TÜRRAHMEN DUOTHERM / THERMO PRIME TÜRRAHMEN ALUTHERM PRIME
- VERSTELLBARE 3D-BÄNDER MIT BLENDEN IN DER FARBE DER BÄNDER
- WÄRMEISOLIERTE SCHWELLE
- BESCHLÄGE-SET MIT SCHLIESSZYLINDER-SCHUTZ
- TÜRROSETTEN BERGEN MIT TÜRDRÜCKERN ALEX
- SCHLIESSZYLINDER IN KLASSE 5, EIN-SCHLÜSSEL-SYSTEM FÜR TÜREN THERMO PREMIUM

AUFPREISS

SONDERHÖHE (THERMO PRIME)	2150 - 2200 mm	✓	
VERFÜGBARE FARBEN: FRP, FDE, FDW, FKG, FKF	2250 - 2300 mm	✓	
	2350 - 2400 mm	✓	
TÜRRAHMEN ALUTHERM PREMIUM (TÜREN THERMO PREMIUM)	✓	GRIFF AMSTERDAM / MONTREAL 1500 mm, EMPFOHLENE ELEKTROVERRIEGELUNG	✓
MASSE 100E	✓	GRIFF AMSTERDAM / MONTREAL 1000 mm, EMPFOHLENE ELEKTROVERRIEGELUNG	✓
VERKÜRZUNG DER TÜREN (10, 20, 30, 40, 60, 80, 100 mm)	✓	GRIFF MIT DRÜCKER AMSTERDAM / MONTREAL 1500 mm MIT TÜRLATTANPASSUNG, ERFORDERLICHE ELEKTROVERRIEGELUNG	✓
TÜREN IN ZWEIFARBIGER AUSFÜHRUNG	✓	GRIFF MIT DRÜCKER AMSTERDAM / MONTREAL 1000 mm MIT TÜRLATTANPASSUNG, ERFORDERLICHE ELEKTROVERRIEGELUNG	✓
SCHLIESSZYLINDER IN KLASSE 6 IM 1-SCHLÜSSEL-SYSTEM	✓	ELEKTROVERRIEGELUNG MIT TAG-/NACHT-FUNKTION	✓
SCHUTZ DER OBEREN TÜRROSETTE (THERMO PREMIUM)	✓	REED-RELAIS	✓
TÜRDRÜCKER/TÜRKNÄUF	✓	SET TEDEE	✓

* FIXE ALUMINIUM-SEITENLICHTER AUF SEITE 88-89, VOLLSTÄNDIGE LISTE MIT ZUBEHÖRTEILEN AUF SEITE 94-99

SCHEIBEN



MATT



MIRA STAR (SPIEGELGLAS)

FARBEN DER TÜREN

ALPINE NUSSBAUM



FRR

MAHAGONI



FMA

BRAZILIAN NUSSBAUM



FRB

NUSSBAUM HELL



FRP

GOLDEICHE



FDE

WINCHESTER



FDW

LIGHT WENGE



FEJ

WEISS



FSB

STAHLGRAU



FKZ

ANTHRAZIT



FKG

ANTHRAZIT DUNKEL



FKF

SCHWARZ



FKC



KW3B JENA 3 B

KONFIGURATION DER TÜR THERMO PRIME 75



INNENSEITE

INNENSEITE

TÜRBSCHLÄGE

TÜRDRÜCKER-
TÜRDRÜCKER



THERMO PRIME



THERMO PREMIUM

TÜRDRÜCKER-
TÜRKNÄUF



THERMO PRIME



THERMO PREMIUM

GRIFF



- AMSTERDAM
- MONTREAL

FARBEN
DER BESCHLÄGE

ANODISIERSCHICHT
PLATINFARBEN



ANODISIERSCHICHT
SILBERN



ANODISIERSCHICHT
SCHWARZ



FARBEN DER TÜREN

ALPINE NUSSBAUM



FRR

MAHAGONI



FMA

BRAZILIAN NUSSBAUM



FRB

NUSSBAUM HELL



FRP

GOLDEICHE



FDE

WINCHESTER



FDW

LIGHT WENGE



FEJ

WEISS



FSB

STAHLGRAU



FKZ

ANTHRAZIT



FKG

ANTHRAZIT DUNKEL



FKF

SCHWARZ



FKC



KWF BAMBERG 1



KWG BAMBERG 2

GRÖSSE

80

90N

90E

100E

MODEL

	THERMO PREMIUM 60	THERMO PREMIUM 75	THERMO PRIME 75
KWF / KWFB BAMBERG 1	✓	✓	✓
KWG / KWGB BAMBERG 2	✓	✓	✓
KWH / KWHB BAMBERG 3	✓	✓	✓
KWI / KWIB BAMBERG 4	✓	✓	✓

STANDARD AUSSTATTUNG RC2

- TÜRLATT VERGLAST, ERFÜLLT DIE BEDINGUNGEN DES PROGRAMMS „REINE LUFT“
- 4 TÜRLATT-FALZE
- THERMO PREMIUM TÜRRAHMEN DUOTHERM / THERMO PRIME TÜRRAHMEN ALUTHERM PRIME
- VERSTELLBARE 3D-BÄNDER MIT BLENCEN IN DER FARBE DER BÄNDER
- WÄRMEISOLIERTE SCHWELLE
- BESCHLÄGE-SET MIT SCHLIESSZYLINDER-SCHUTZ
- TÜRROSETTEN BERGEN MIT TÜRDRÜCKERN ALEX
- SCHLIESSZYLINDER IN KLASSE 5, EIN-SCHLÜSSEL-SYSTEM FÜR TÜREN THERMO PREMIUM

• INSERTS

INOX

SCHWARZ

AUFPREISS

SONDERHÖHE (THERMO PRIME)	2150 - 2200 mm	✓
VERFÜGBARE FARBEN: FRP, FDE, FDW, FKG, FKJ	2250 - 2300 mm	✓
	2350 - 2400 mm	✓
TÜRRAHMEN ALUTHERM PREMIUM (TÜREN THERMO PREMIUM)	✓ GRIFF AMSTERDAM / MONTREAL 1500 mm, EMPFOHLENE ELEKTROVERRIEGELUNG	✓
MASSE 100E	✓ GRIFF AMSTERDAM / MONTREAL 1000 mm, EMPFOHLENE ELEKTROVERRIEGELUNG	✓
VERKÜRZUNG DER TÜREN (10, 20, 30, 40 mm)	✓ GRIFF MIT DRÜCKER AMSTERDAM / MONTREAL 1500 mm MIT TÜRLATTANPASSUNG, ERFORDERLICHE ELEKTROVERRIEGELUNG	✓
TÜREN IN ZWEIFARBIGER AUSFÜHRUNG	✓ GRIFF MIT DRÜCKER AMSTERDAM / MONTREAL 1000 mm MIT TÜRLATTANPASSUNG, ERFORDERLICHE ELEKTROVERRIEGELUNG	✓
SCHLIESSZYLINDER IN KLASSE 6 IM 1-SCHLÜSSEL-SYSTEM	✓ ELEKTROVERRIEGELUNG MIT TAG-/NACHT-FUNKTION	✓
SCHUTZ DER OBEREN TÜRROSETTE (THERMO PREMIUM)	✓ REED-RELAIS	✓
TÜRDRÜCKER/TÜRKNAUF	✓ SET TEDEE	✓

* FIXE ALUMINIUM-SEITENLICHTER AUF SEITE 88-89, VOLLSTÄNDIGE LISTE MIT ZUBEHÖRTEILEN AUF SEITE 94-99

SCHEIBEN



MATT



MIRA STAR (SPIEGELGLAS)

FARBEN DER TÜREN

ALPINE NUSSBAUM

FRR

MAHAGONI

FMA

BRAZILIAN NUSSBAUM

FRB

NUSSBAUM HELL

FRP

GOLDEICHE

FDE

WINCHESTER

FDW

LIGHT WENGE

FEJ

WEISS

FSB

STAHLGRAU

FKZ

ANTHRAZIT

FKG

ANTHRAZIT DUNKEL

FKF

SCHWARZ

FKC



KWHB BAMBERG 3 B



KWI BAMBERG 4



INNENSEITE

KONFIGURATION DER TÜR THERMO PRIME 75



KWF BAMBERG 1



INNENSEITE

TÜRBSCHLÄGE

TÜRDRÜCKER-
TÜRDRÜCKER



THERMO PRIME



THERMO PREMIUM

TÜRDRÜCKER-
TÜRKNÄUF



THERMO PRIME



THERMO PREMIUM

GRIFF



□ AMSTERDAM
○ MONTREAL

FARBEN
DER BESCHLÄGE

ANODISIERSCHEIT
PLATINFARBEN



ANODISIERSCHEIT
SILBERN



ANODISIERSCHEIT
SCHWARZ



FARBEN DER TÜREN

ALPINE NUSSBAUM



FRR

MAHAGONI



FMA

BRAZILIAN NUSSBAUM



FRB

NUSSBAUM HELL



FRP

GOLDEICHE



FDE

WINCHESTER



FDW

LIGHT WENGE



FEJ

WEISS



FSB

STAHLGRAU



FKZ

ANTHRAZIT



FKG

ANTHRAZIT DUNKEL



FKF

SCHWARZ



FKC



KWJB ULM 1 B



KWK ULM 2

GRÖSSE	80	90N	90E	100E
--------	----	-----	-----	------

MODEL	THERMO PREMIUM 60	THERMO PREMIUM 75	THERMO PRIME 75
KWJ / KWJB ULM 1	✓	✓	-
KWK / KWKB ULM 2	✓	✓	✓

STANDARD AUSSTATTUNG RC2

- TÜRBLATT VERGLAST, ERFÜLLT DIE BEDINGUNGEN DES PROGRAMMS „REINE LUFT“
- 4 TÜRBLATT-FALZE
- THERMO PREMIUM TÜRRAHMEN DUOTHERM / THERMO PRIME TÜRRAHMEN ALUTHERM PRIME
- VERSTELLBARE 3D-BÄNDER MIT BLENDEN IN DER FARBE DER BÄNDER
- WÄRMEISOLIERTE SCHWELLE
- BESCHLÄGE-SET MIT SCHLIESSZYLINDER-SCHUTZ
- TÜRROSETTEN BERGEN MIT TÜRDRÜCKERN ALEX
- SCHLIESSZYLINDER IN KLASSE 5, EIN-SCHLÜSSEL-SYSTEM FÜR TÜREN THERMO PREMIUM

• INSERTS **INOX** **SCHWARZ**

AUFPREISS

SONDERHÖHE (THERMO PRIME)	2150 - 2200 mm	✓
VERFÜGBARE FARBEN: FRP, FDE, FDW, FKG, FKF	2250 - 2300 mm	✓
	2350 - 2400 mm	✓
TÜRRAHMEN ALUTHERM PREMIUM (TÜREN THERMO PREMIUM)	✓ GRIFF AMSTERDAM / MONTREAL 1500 mm, EMPFOHLENE ELEKTROVERRIEGELUNG	✓
MASSE 100E	✓ GRIFF AMSTERDAM / MONTREAL 1000 mm, EMPFOHLENE ELEKTROVERRIEGELUNG	✓
VERKÜRZUNG DER TÜREN (10, 20, 30, 40, 60, 80, 100 mm)	✓ GRIFF MIT DRÜCKER AMSTERDAM / MONTREAL 1500 mm MIT TÜRBLATTANPASSUNG, ERFORDERLICHE ELEKTROVERRIEGELUNG	✓
TÜREN IN ZWEIFARBIGER AUSFÜHRUNG	✓ GRIFF MIT DRÜCKER AMSTERDAM / MONTREAL 1000 mm MIT TÜRBLATTANPASSUNG, ERFORDERLICHE ELEKTROVERRIEGELUNG	✓
SCHLIESSZYLINDER IN KLASSE 6 IM 1-SCHLÜSSEL-SYSTEM	✓ ELEKTROVERRIEGELUNG MIT TAG-/NACHT-FUNKTION	✓
SCHUTZ DER OBEREN TÜRROSETTE (THERMO PREMIUM)	✓ REED-RELAIS	✓
TÜRDRÜCKER/TÜRKNÄUF	✓ SET TEDEE	✓

* FIXE ALUMINIUM-SEITENLICHTER AUF SEITE 88-89, VOLLSTÄNDIGE LISTE MIT ZUBEHÖRTEILEN AUF SEITE 94-99

SCHEIBE



MATT



MIRA STAR (SPIEGELGLAS)



FARBEN DER TÜREN

ALPINE NUSSBAUM



FRR

MAHAGONI



FMA

BRAZILIAN NUSSBAUM



FRB

NUSSBAUM HELL



FRP

GOLDEICHE



FDE

WINCHESTER



FDW

LIGHT WENGE



FEJ

WEISS



FSB

STAHLGRAU



FKZ

ANTHRAZIT



FKG

ANTHRAZIT DUNKEL



FKF

SCHWARZ



FKC



KWJ ULM 2

KONFIGURATION DER TÜR THERMO PRIME 75



INNENSEITE

INNENSEITE

TÜRBSCHLÄGE

TÜRDRÜCKER-
-TÜRDRÜCKER



THERMO PRIME



THERMO PREMIUM

TÜRDRÜCKER-
-TÜRKNÄUF



THERMO PRIME



THERMO PREMIUM

GRIFF



- AMSTERDAM
- MONTREAL

FARBEN
DER BESCHLÄGE

ANODISIERSCHICHT
PLATINFARBEN



ANODISIERSCHICHT
SILBERN



ANODISIERSCHICHT
SCHWARZ



FARBEN DER TÜREN

ALPINE NUSSBAUM



FRR

MAHAGONI



FMA

BRAZILIAN NUSSBAUM



FRB

NUSSBAUM HELL



FRP

GOLDEICHE



FDE

WINCHESTER



FDW

LIGHT WENGE



FEJ

WEISS



FSB

STAHLGRAU



FKZ

ANTHRAZIT



FKG

ANTHRAZIT DUNKEL



FKF

SCHWARZ



FKC



KWL TREWIR 1



KWMB TREWIR 2 B

GRÖSSE	80	90N	90E	100E
--------	----	-----	-----	------

MODEL	THERMO PREMIUM 60	THERMO PREMIUM 75	THERMO PRIME 75
KWL / KWL B TREWIR 1	✓	✓	✓
KWM / KWMB TREWIR 2	✓	✓	✓
KWN / KWNB TREWIR 3	✓	✓	✓
KWP / KWPB TREWIR 4	✓	✓	✓
KW7 / KW7B TREWIR 7	✓	✓	✓

STANDARD AUSSTATTUNG RC2

- TÜRLATT VERGLAST, ERFÜLLT DIE BEDINGUNGEN DES PROGRAMMS „REINE LUFT“
 - 4 TÜRLATT-FALZE
 - THERMO PREMIUM TÜRRAHMEN DUOTHERM / THERMO PRIME TÜRRAHMEN ALUTHERM PRIME
 - VERSTELLBARE 3D-BÄNDER MIT BLENDEN IN DER FARBE DER BÄNDER
 - WÄRMEISOLIERTE SCHWELLE
 - BESCHLÄGE-SET MIT SCHLIESSZYLINDER-SCHUTZ
 - TÜRROSETTEN BERGEN MIT TÜRDRÜCKERN ALEX
 - SCHLIESSZYLINDER IN KLASSE 5, EIN-SCHLÜSSEL-SYSTEM FÜR TÜREN THERMO PREMIUM
- INSERTS **INOX** **SCHWARZ**

AUFPREISS

SONDERHÖHE (THERMO PRIME)	2150 - 2200 mm	✓
VERFÜGBARE FARBEN: FRP, FDE, FDW, FKG, FKF	2250 - 2300 mm	✓
	2350 - 2400 mm	✓
TÜRRAHMEN ALUTHERM PREMIUM (TÜREN THERMO PREMIUM)	✓ GRIFF AMSTERDAM / MONTREAL 1500 mm, EMPFOHLENE ELEKTROVERRIEGELUNG	✓
MASSE 100E	✓ GRIFF AMSTERDAM / MONTREAL 1000 mm, EMPFOHLENE ELEKTROVERRIEGELUNG	✓
VERKÜRZUNG DER TÜREN (10, 20, 30, 40 mm)	✓ GRIFF MIT DRÜCKER AMSTERDAM / MONTREAL 1500 mm MIT TÜRLATTANPASSUNG, ERFORDERLICHE ELEKTROVERRIEGELUNG	✓
TÜREN IN ZWEIFARBIGER AUSFÜHRUNG	✓ GRIFF MIT DRÜCKER AMSTERDAM / MONTREAL 1000 mm MIT TÜRLATTANPASSUNG, ERFORDERLICHE ELEKTROVERRIEGELUNG	✓
SCHLIESSZYLINDER IN KLASSE 6 IM 1-SCHLÜSSEL-SYSTEM	✓ ELEKTROVERRIEGELUNG MIT TAG-/NACHT-FUNKTION	✓
SCHUTZ DER OBEREN TÜRROSETTE (THERMO PREMIUM)	✓ REED-RELAIS	✓
TÜRDRÜCKER/TÜRKNÄUF	✓ SET TEDEE	✓

* FIXE ALUMINIUM-SEITENLICHTER AUF SEITE 88-89, VOLLSTÄNDIGE LISTE MIT ZUBEHÖRTEILEN AUF SEITE 94-99

SCHEIBEN



MATT



GRAFIT



MIRA STAR (SPIEGELGLAS)

FARBEN DER TÜREN

ALPINE NUSSBAUM



FRR

MAHAGONI



FMA

BRAZILIAN NUSSBAUM



FRB

NUSSBAUM HELL



FRP

GOLDEICHE



FDE

WINCHESTER



FDW

LIGHT WENGE



FEJ

WEISS



FSB

STAHLGRAU



FKZ

ANTHRAZIT



FKG

ANTHRAZIT DUNKEL



FKF

SCHWARZ



FKC



KWN TREWIR 3



KWP TREWIR 4



KW7 TREWIR 7

KONFIGURATION DER TÜR THERMO PRIME 75



KWL TREWIR 1



INNENSEITE

TÜR BESCHLÄGE

TÜRDRÜCKER-
TÜRDRÜCKER



THERMO PRIME



THERMO PREMIUM

TÜRDRÜCKER-
TÜRKNÄUF



THERMO PRIME



THERMO PREMIUM

GRIFF



□ AMSTERDAM
○ MONTREAL

FARBEN
DER BESCHLÄGE

ANODISIERSCHICHT
PLATINFARBEN



ANODISIERSCHICHT
SILBERN



ANODISIERSCHICHT
SCHWARZ



FARBEN DER TÜREN

ALPINE NUSSBAUM



FRR

MAHAGONI



FMA

BRAZILIAN NUSSBAUM



FRB

NUSSBAUM HELL



FRP

GOLDEICHE



FDE

WINCHESTER



FDW

LIGHT WENGE



FEJ

WEISS



FSB

STAHLGRAU



FKZ

ANTHRAZIT



FKG

ANTHRAZIT DUNKEL



FKF

SCHWARZ



FKC



KWSB DORFEN B

GRÖSSE	80	90N	90E	100E
--------	----	-----	-----	------

MODEL	THERMO PREMIUM 60	THERMO PREMIUM 75	THERMO PRIME 75
KWS / KWSB DORFEN	✓	✓	✓

STANDARD AUSSTATTUNG RC2

- TÜRLBLATT VERGLAST, ERFÜLLT DIE BEDINGUNGEN DES PROGRAMMS „REINE LUFT“
- WÄRMEISOLIERTE SCHWELLE
- 4 TÜRLBLATT-FALZE
- BESCHLÄGE-SET MIT SCHLIESSZYLINDER-SCHUTZ
- THERMO PREMIUM TÜRRAHMEN DUOTHERM / THERMO PRIME TÜRRAHMEN ALUTHERM PRIME
- TÜRROSETTEN BERGEN MIT TÜRDRÜCKERN ALEX
- VERSTELLBARE 3D-BÄNDER MIT BLENDEN IN DER FARBE DER BÄNDER
- SCHLIESSZYLINDER IN KLASSE 5, EIN-SCHLÜSSEL-SYSTEM FÜR TÜREN THERMO PREMIUM
- INSERTS **INOX** **SCHWARZ**

AUFPREISS

SONDERHÖHE (THERMO PRIME)	2150 - 2200 mm	✓
VERFÜGBARE FARBEN: FRP, FDE, FDW, FKG, FKF	2250 - 2300 mm	✓
	2350 - 2400 mm	✓
TÜRRAHMEN ALUTHERM PREMIUM (TÜREN THERMO PREMIUM)	✓ GRIFF AMSTERDAM / MONTREAL 1500 mm, EMPFOHLENE ELEKTROVERRIEGELUNG	✓
MASSE 100E	✓ GRIFF AMSTERDAM / MONTREAL 1000 mm, EMPFOHLENE ELEKTROVERRIEGELUNG	✓
VERKÜRZUNG DER TÜREN (10, 20, 30, 40 mm)	✓ GRIFF MIT DRÜCKER AMSTERDAM / MONTREAL 1500 mm MIT TÜRLBLATTANPASSUNG, ERFORDERLICHE ELEKTROVERRIEGELUNG	✓
TÜREN IN ZWEIFARBIGER AUSFÜHRUNG	✓ GRIFF MIT DRÜCKER AMSTERDAM / MONTREAL 1000 mm MIT TÜRLBLATTANPASSUNG, ERFORDERLICHE ELEKTROVERRIEGELUNG	✓
SCHLIESSZYLINDER IN KLASSE 6 IM 1-SCHLÜSSEL-SYSTEM	✓ ELEKTROVERRIEGELUNG MIT TAG-/NACHT-FUNKTION	✓
SCHUTZ DER OBEREN TÜRROSETTE (THERMO PREMIUM)	✓ VERDECKT INSTALLIERTER TÜRSCHLIESSER	✓
TÜRDRÜCKER/TÜRKNAUF	✓ REED-RELAIS	✓
	SET TEDEE	✓

* FIXE ALUMINIUM-SEITENLICHTER AUF SEITE 88-89, VOLLSTÄNDIGE LISTE MIT ZUBEHÖRTEILEN AUF SEITE 94-99

SCHEIBEN



MATT



GRAFIT



MIRA STAR (SPIEGELGLAS)

FARBEN DER TÜREN

ALPINE NUSSBAUM



FRR

MAHAGONI



FMA

BRAZILIAN NUSSBAUM



FRB

NUSSBAUM HELL



FRP

GOLDEICHE



FDE

WINCHESTER



FDW

LIGHT WENGE



FEJ

WEISS



FSB

STAHLGRAU



FKZ

ANTHRAZIT



FKG

ANTHRAZIT DUNKEL



FKF

SCHWARZ



FKC



KWS DORFEN

KONFIGURATION DER TÜR THERMO PRIME 75



INNENSEITE

INNENSEITE

TÜRBSCHLÄGE

TÜRDRÜCKER-
-TÜRDRÜCKER



THERMO PRIME



THERMO PREMIUM

TÜRDRÜCKER-
-TÜRKNÄUF



THERMO PRIME



THERMO PREMIUM

GRIFF



- AMSTERDAM
- MONTREAL

FARBEN
DER BESCHLÄGE

ANODISIERSCHICHT
PLATINFARBEN



ANODISIERSCHICHT
SILBERN



ANODISIERSCHICHT
SCHWARZ



FARBEN DER TÜREN

ALPINE NUSSBAUM



FRR

MAHAGONI



FMA

BRAZILIAN NUSSBAUM



FRB

NUSSBAUM HELL



FRP

GOLDEICHE



FDE

WINCHESTER



FDW

LIGHT WENGE



FEJ

WEISS



FSB

STAHLGRAU



FKZ

ANTHRAZIT



FKG

ANTHRAZIT DUNKEL



FKF

SCHWARZ



FKC



KWT KASSEL 1



KWXB KASSEL 2 B

GRÖSSE	80	90N	90E	100E
--------	----	-----	-----	------

MODEL	THERMO PREMIUM 60	THERMO PREMIUM 75	THERMO PRIME 75
KWT / KWTB KASSEL 1	✓	✓	✓
KWX / KWXB KASSEL 2	✓	✓	✓

STANDARD AUSSTATTUNG RC2

- TÜRBLATT VERGLAST, ERFÜLLT DIE BEDINGUNGEN DES PROGRAMMS „REINE LUFT“
- 4 TÜRBLATT-FALZE
- THERMO PREMIUM TÜRRAHMEN DUOTHERM / THERMO PRIME TÜRRAHMEN ALUTHERM PRIME
- VERSTELLBARE 3D-BÄNDER MIT BLENDEN IN DER FARBE DER BÄNDER
- WÄRMEISOLIERTE SCHWELLE
- BESCHLÄGE-SET MIT SCHLISSZYLINDER-SCHUTZ
- TÜRROSETTEN BERGEN MIT TÜRDRÜCKERN ALEX
- SCHLISSZYLINDER IN KLASSE 5, EIN-SCHLÜSSEL-SYSTEM FÜR TÜREN THERMO PREMIUM

• INSERTS **INOX** **SCHWARZ**

AUFPREISS

SONDERHÖHE (THERMO PRIME)	2150 - 2200 mm	✓	
VERFÜGBARE FARBEN: FRP, FDE, FDW, FKG, FKF	2250 - 2300 mm	✓	
	2350 - 2400 mm	✓	
TÜRRAHMEN ALUTHERM PREMIUM (TÜREN THERMO PREMIUM)	✓	GRIFF AMSTERDAM / MONTREAL 1500 mm, EMPFOHLENE ELEKTROVERRIEGELUNG	✓
MASSE 100E	✓	GRIFF AMSTERDAM / MONTREAL 1000 mm, EMPFOHLENE ELEKTROVERRIEGELUNG	✓
VERKÜRZUNG DER TÜREN (10, 20, 30, 40 mm)	✓	GRIFF MIT DRÜCKER AMSTERDAM / MONTREAL 1500 mm MIT TÜRBLATTANPASSUNG, ERFORDERLICHE ELEKTROVERRIEGELUNG	✓
TÜREN IN ZWEIFARBIGER AUSFÜHRUNG	✓	GRIFF MIT DRÜCKER AMSTERDAM / MONTREAL 1000 mm MIT TÜRBLATTANPASSUNG, ERFORDERLICHE ELEKTROVERRIEGELUNG	✓
SCHLISSZYLINDER IN KLASSE 6 IM 1-SCHLÜSSEL-SYSTEM	✓	ELEKTROVERRIEGELUNG MIT TAG-/NACHT-FUNKTION	✓
SCHUTZ DER OBEREN TÜRROSETTE (THERMO PREMIUM)	✓	REED-RELAIS	✓
TÜRDRÜCKER/TÜRKNAUF	✓	SET TEDEE	✓

* FIXE ALUMINIUM-SEITENLICHTER AUF SEITE 88-89, VOLLSTÄNDIGE LISTE MIT ZUBEHÖRTEILEN AUF SEITE 94-99

SCHEIBEN



MATT



GRAFIT



MIRA STAR (SPIEGELGLAS)

FARBEN DER TÜREN

ALPINE NUSSBAUM



FRR

MAHAGONI



FMA

BRAZILIAN NUSSBAUM



FRB

NUSSBAUM HELL



FRP

GOLDEICHE



FDE

WINCHESTER



FDW

LIGHT WENGE



FEJ

WEISS



FSB

STAHLGRAU



FKZ

ANTHRAZIT



FKG

ANTHRAZIT DUNKEL



FKF

SCHWARZ



FKC



KWT KASSEL 1

KONFIGURATION DER TÜR THERMO PRIME 75



INNENSEITE

INNENSEITE

TÜRBSCHLÄGE

TÜRDRÜCKER-
-TÜRDRÜCKER



THERMO PRIME



THERMO PREMIUM

TÜRDRÜCKER-
-TÜRKNAUF



THERMO PRIME



THERMO PREMIUM

GRIFF



- AMSTERDAM
- MONTREAL

FARBEN
DER BESCHLÄGE

ANODISIERSCHICHT
PLATINFARBEN



ANODISIERSCHICHT
SILBERN



ANODISIERSCHICHT
SCHWARZ



FARBEN DER TÜREN

ALPINE NUSSBAUM



FRR

MAHAGONI



FMA

BRAZILIAN NUSSBAUM



FRB

NUSSBAUM HELL



FRP

GOLDEICHE



FDE

WINCHESTER



FDW

LIGHT WENGE



FEJ

WEISS



FSB

STAHLGRAU



FKZ

ANTHRAZIT



FKG

ANTHRAZIT DUNKEL



FKF

SCHWARZ



FKC



KPN KRONACH 1



KPPB KRONACH 2 B

GRÖSSE	80	90N	90E	100E
--------	----	-----	-----	------

MODEL	THERMO PREMIUM 60	THERMO PREMIUM 75	THERMO PRIME 75
KPN / KPNB KRONACH 1	✓	✓	✓
KPP / KPPB KRONACH 2	✓	✓	✓
KPT / KPTB KRONACH 3	✓	✓	-
KPZ / KPZB KRONACH 4	✓	✓	-

STANDARD AUSSTATTUNG RC2

- TÜRBLATT ERFÜLLT DIE BEDINGUNGEN DES PROGRAMMS „REINE LUFT“
 - WÄRMEISOLIERTE SCHWELLE
 - 4 TÜRBLATT-FALZE
 - BESCHLÄGE-SET MIT SCHLIESSZYLINDER-SCHUTZ
 - THERMO PREMIUM TÜRRAHMEN DUOTHERM / THERMO PRIME TÜRRAHMEN ALUTHERM PRIME
 - TÜRROSETTEN BERGEN MIT TÜRDRÜCKERN ALEX
 - VERSTELLBARE 3D-BÄNDER MIT BLENDEN IN DER FARBE DER BÄNDER
 - SCHLIESSZYLINDER IN KLASSE 5, EIN-SCHLÜSSEL-SYSTEM FÜR TÜREN THERMO PREMIUM
- INSERTS **INOX** **SCHWARZ**

AUFPREISS

SONDERHÖHE (THERMO PRIME)	2150 - 2200 mm	✓
VERFÜGBARE FARBEN: FRP, FDE, FDW, FKG, FKJ	2250 - 2300 mm	✓
	2350 - 2400 mm	✓
TÜRRAHMEN ALUTHERM PREMIUM (TÜREN THERMO PREMIUM)	✓ GRIFF AMSTERDAM / MONTREAL 1500 mm, EMPFOHLENE ELEKTROVERRIEGELUNG	✓
MASSE 100E	✓ GRIFF AMSTERDAM / MONTREAL 1000 mm, EMPFOHLENE ELEKTROVERRIEGELUNG	✓
RC3 PAKET	✓ GRIFF MIT DRÜCKER AMSTERDAM / MONTREAL 1500 mm MIT TÜRBLATTANPASSUNG, ERFORDERLICHE ELEKTROVERRIEGELUNG	✓
TÜREN IN ZWEIFARBIGER AUSFÜHRUNG	✓ GRIFF MIT DRÜCKER AMSTERDAM / MONTREAL 1000 mm MIT TÜRBLATTANPASSUNG, ERFORDERLICHE ELEKTROVERRIEGELUNG	✓
VERKÜRZUNG DER TÜREN (10, 20, 30, 40 mm)	✓ ELEKTROVERRIEGELUNG MIT TAG-/NACHT-FUNKTION	✓
SCHLIESSZYLINDER IN KLASSE 6 IM 1-SCHLÜSSEL-SYSTEM	✓ VERDECKT INSTALLIERTER TÜRSCHEISSER	✓
SCHUTZ DER OBEREN TÜRROSETTE (THERMO PREMIUM)	✓ REED-RELAIS	✓
TÜRDRÜCKER/TÜRKNAUF	✓ SET TEDEE	✓
INSERT UND APPLIKATION ZWEITE SEITE	✓ INSERT ZWEITE SEITE	✓

* FIXE ALUMINIUM-SEITENLICHTER AUF SEITE 88-89, VOLLSTÄNDIGE LISTE MIT ZUBEHÖRTEILEN AUF SEITE 94-99

FARBEN DER TÜREN

ALPINE NUSSBAUM



FRR

MAHAGONI



FMA

BRAZILIAN NUSSBAUM



FRB

NUSSBAUM HELL



FRP

GOLDEICHE



FDE

WINCHESTER



FDW

LIGHT WENGE



FEJ

WEISS



FSB

STAHLGRAU



FKZ

ANTHRAZIT



FKG

ANTHRAZIT DUNKEL



FKF

SCHWARZ



FKC



KPT KRONACH 3



KPZ KRONACH 4



INNENSEITE

KONFIGURATION DER TÜR THERMO PRIME 75



KPN KRONACH 1



INNENSEITE

TÜRBSCHLÄGE

TÜRDRÜCKER-
-TÜRDRÜCKER



THERMO PRIME



THERMO PREMIUM

TÜRDRÜCKER-
-TÜRKNAUF



THERMO PRIME



THERMO PREMIUM

GRIFF



□ AMSTERDAM
○ MONTREAL

FARBEN
DER BESCHLÄGE

ANODISIERSCHEIT
PLATINFARBEN



ANODISIERSCHEIT
SILBERN



ANODISIERSCHEIT
SCHWARZ



FARBEN DER TÜREN

ALPINE NUSSBAUM



MAHAGONI



BRAZILIAN NUSSBAUM



NUSSBAUM HELL



GOLDEICHE



WINCHESTER



LIGHT WENGE



WEISS



STAHLGRAU



ANTHRAZIT



ANTHRAZIT DUNKEL



SCHWARZ





KPJ REGEN 1



KPK REGEN 2

GRÖSSE	80	90N	90E	100E
--------	----	-----	-----	------

MODEL	THERMO PREMIUM 60	THERMO PREMIUM 75	THERMO PRIME 75
KPJ / KPJB REGEN 1	✓	✓	✓
KPK / KPKB REGEN 2	✓	✓	✓
KPL / KPLB REGEN 3	✓	✓	✓
KPS / KPSB REGEN 4	✓	✓	✓
KPM / KPMB REGEN 5	✓	✓	✓
KPR / KPRB REGEN 6	✓	✓	✓

STANDARD AUSSTATTUNG RC2

- TÜRLATT ERFÜLLT DIE BEDINGUNGEN DES PROGRAMMS „REINE LUFT“
 - WÄRMEISOLIERTE SCHWELLE
 - 4 TÜRLATT-FALZE
 - BESCHLÄGE-SET MIT SCHLIESSZYLINDER-SCHUTZ
 - THERMO PREMIUM TÜRRAHMEN DUOTHERM / THERMO PRIME TÜRRAHMEN ALUTHERM PRIME
 - TÜRROSETTEN BERGEN MIT TÜRDRÜCKERN ALEX
 - VERSTELLBARE 3D-BÄNDER MIT BLENDEN IN DER FARBE DER BÄNDER
 - SCHLIESSZYLINDER IN KLASSE 5, EIN-SCHLÜSSEL-SYSTEM FÜR TÜREN THERMO PREMIUM
- INSERTS **INOX** **SCHWARZ**

AUFPREISS

SONDERHÖHE (THERMO PRIME)	2150 - 2200 mm	✓
VERFÜGBARE FARBEN: FRP, FDE, FDW, FKG, FKF	2250 - 2300 mm	✓
	2350 - 2400 mm	✓
TÜRRAHMEN ALUTHERM PREMIUM (TÜREN THERMO PREMIUM)	✓ GRIFF AMSTERDAM / MONTREAL 1500 mm, EMPFOHLENE ELEKTROVERRIEGELUNG	✓
MASSE 100E	✓ GRIFF AMSTERDAM / MONTREAL 1000 mm, EMPFOHLENE ELEKTROVERRIEGELUNG	✓
RC3 PAKET	✓ GRIFF MIT DRÜCKER AMSTERDAM / MONTREAL 1500 mm MIT TÜRLATTANPASSUNG, ERFORDERLICHE ELEKTROVERRIEGELUNG	✓
TÜREN IN ZWEIFARBIGER AUSFÜHRUNG	✓ GRIFF MIT DRÜCKER AMSTERDAM / MONTREAL 1000 mm MIT TÜRLATTANPASSUNG, ERFORDERLICHE ELEKTROVERRIEGELUNG	✓
VERKÜRZUNG DER TÜREN (10, 20, 30, 40 mm)	✓ ELEKTROVERRIEGELUNG MIT TAG-/NACHT-FUNKTION	✓
SCHLIESSZYLINDER IN KLASSE 6 IM 1-SCHLÜSSEL-SYSTEM	✓ VERDECKT INSTALLIERTER TÜRSCHLIESSER	✓
SCHUTZ DER OBEREN TÜRROSETTE (THERMO PREMIUM)	✓ REED-RELAIS	✓
TÜRDRÜCKER/TÜRKNAUF	✓ SET TEDEE	✓
INSERT UND APPLIKATION ZWEITE SEITE	✓ INSERT ZWEITE SEITE	✓

* FIXE ALUMINIUM-SEITENLICHTER AUF SEITE 88-89, VOLLSTÄNDIGE LISTE MIT ZUBEHÖRTEILEN AUF SEITE 94-99

FARBEN DER TÜREN

ALPINE NUSSBAUM



FRR

MAHAGONI



FMA

BRAZILIAN NUSSBAUM



FRB

NUSSBAUM HELL



FRP

GOLDEICHE



FDE

WINCHESTER



FDW

LIGHT WENGE



FEJ

WEISS



FSB

STAHLGRAU



FKZ

ANTHRAZIT



FKG

ANTHRAZIT DUNKEL



FKF

SCHWARZ



FKC



KPL REGEN 3



KPS REGEN 4



KPM REGEN 5

KONFIGURATION DER TÜR THERMO PRIME 75



KPRB REGEN 6 B



KPJ REGEN 1



INNENSEITE

TÜRBSCHLÄGE

TÜRDRÜCKER-
TÜRDRÜCKER



THERMO PRIME



THERMO PREMIUM

TÜRDRÜCKER-
TÜRKNAUF



THERMO PRIME



THERMO PREMIUM

GRIFF



□ AMSTERDAM
○ MONTREAL

FARBEN
DER BESCHLÄGE

ANODISIERSCHICHT
PLATINFARBEN



ANODISIERSCHICHT
SILBERN



ANODISIERSCHICHT
SCHWARZ



FARBEN DER TÜREN

ALPINE NUSSBAUM



FRR

MAHAGONI



FMA

BRAZILIAN NUSSBAUM



FRB

NUSSBAUM HELL



FRP

GOLDEICHE



FDE

WINCHESTER



FDW

LIGHT WENGE



FEJ

WEISS



FSB

STAHLGRAU



FKZ

ANTHRAZIT



FKG

ANTHRAZIT DUNKEL



FKF

SCHWARZ



FKC



KPE DREZNO 1



KPFB DREZNO 2 B

GRÖSSE	80	90N	90E	100E
--------	----	-----	-----	------

MODEL	THERMO PREMIUM 60	THERMO PREMIUM 75	THERMO PRIME 75
KPE / KPEB DREZNO 1	✓	✓	-
KPF / KPFB DREZNO 2	✓	✓	-
KPH / KPHE DREZNO 4	✓	✓	✓

STANDARDAUSSTATTUNG RC2

- TÜRBLATT ERFÜLLT DIE BEDINGUNGEN DES PROGRAMMS „REINE LUFT“
- WÄRMEISOLIERTE SCHWELLE
- 4 TÜRBLATT-FALZE
- BESCHLÄGE-SET MIT SCHLIESSZYLINDER-SCHUTZ
- THERMO PREMIUM TÜRRAHMEN DUOTHERM / THERMO PRIME TÜRRAHMEN ALUTHERM PRIME
- TÜRROSETTEN BERGEN MIT TÜRDRÜCKERN ALEX
- VERSTELLBARE 3D-BÄNDER MIT BLENCEN IN DER FARBE DER BÄNDER
- SCHLIESSZYLINDER IN KLASSE 5, EIN-SCHLÜSSEL-SYSTEM FÜR TÜREN THERMO PREMIUM
- INSERTS **INOX** **SCHWARZ**

AUFPREISS

SONDERHÖHE (THERMO PRIME)	2150 - 2200 mm	✓	
VERFÜGBARE FARBEN: FRP, FDE, FDW, FKG, FKF	2250 - 2300 mm	✓	
	2350 - 2400 mm	✓	
TÜRRAHMEN ALUTHERM PREMIUM (TÜREN THERMO PREMIUM)	✓	GRIFF AMSTERDAM / MONTREAL 1500 mm, EMPFOHLENE ELEKTROVERRIEGELUNG	✓
MASSE 100E	✓	GRIFF AMSTERDAM / MONTREAL 1000 mm, EMPFOHLENE ELEKTROVERRIEGELUNG	✓
RC3 PAKET	✓	GRIFF MIT DRÜCKER AMSTERDAM / MONTREAL 1500 mm MIT TÜRBLATTANPASSUNG, ERFORDERLICHE ELEKTROVERRIEGELUNG	✓
TÜREN IN ZWEIFARBIGER AUSFÜHRUNG	✓	GRIFF MIT DRÜCKER AMSTERDAM / MONTREAL 1000 mm MIT TÜRBLATTANPASSUNG, ERFORDERLICHE ELEKTROVERRIEGELUNG	✓
VERKÜRZUNG DER TÜREN KPH (10, 20, 30, 40 mm), KPE, KPF, KPG (10, 20, 30, 40, 60, 80, 100 mm)	✓	ELEKTROVERRIEGELUNG MIT TAG-/NACHT-FUNKTION	✓
SCHLIESSZYLINDER IN KLASSE 6 IM 1-SCHLÜSSEL-SYSTEM	✓	VERDECKT INSTALLIERTER TÜRSCHLIESSER	✓
SCHUTZ DER OBEREN TÜRROSETTE (THERMO PREMIUM)	✓	REED-RELAIS	✓
TÜRDRÜCKER/TÜRKNAUF	✓	SET TEDEE	✓
INSERT ZWEITE SEITE	✓		

* FIXE ALUMINIUM-SEITENLICHTER AUF SEITE 88-89, VOLLSTÄNDIGE LISTE MIT ZUBEHÖRTEILEN AUF SEITE 94-99

FARBEN DER TÜREN

ALPINE NUSSBAUM



FRR

MAHAGONI



FMA

BRAZILIAN NUSSBAUM



FRB

NUSSBAUM HELL



FRP

GOLDEICHE



FDE

WINCHESTER



FDW

LIGHT WENGE



FEJ

WEISS



FSB

STAHLGRAU



FKZ

ANTHRAZIT



FKG

ANTHRAZIT DUNKEL



FKF

SCHWARZ



FKC



KPH DREZNO 4



INNENSEITE

KONFIGURATION DER TÜR THERMO PRIME 75



KPE DREZNO 4



INNENSEITE

TÜR BESCHLÄGE

TÜRDRÜCKER-
-TÜRDRÜCKER



THERMO PRIME



THERMO PREMIUM

TÜRDRÜCKER-
-TÜRKNÄUF



THERMO PRIME



THERMO PREMIUM

GRIFF



□ AMSTERDAM
○ MONTREAL

FARBEN
DER BESCHLÄGE

ANODISIERSCHICHT
PLATINFARBEN



ANODISIERSCHICHT
SILBERN



ANODISIERSCHICHT
SCHWARZ



FARBEN DER TÜREN

ALPINE NUSSBAUM



MAHAGONI



BRAZILIAN NUSSBAUM



NUSSBAUM HELL



GOLDEICHE



WINCHESTER



LIGHT WENGE



WEISS



STAHLGRAU



ANTHRAZIT



ANTHRAZIT DUNKEL



SCHWARZ





KPAB ERFURT 1 B



KPB ERFURT 2

GRÖSSE	80	90N	90E	100E
--------	----	-----	-----	------

MODEL	THERMO PREMIUM 60	THERMO PREMIUM 75	THERMO PRIME 75
KPA / KPAB ERFURT 1	✓	✓	✓
KPB / KPBB ERFURT 2	✓	✓	✓
KPC / KPCB ERFURT 3	✓	✓	✓

STANDARDAUSSTATTUNG RC2

- TÜRLATT ERFÜLLT DIE BEDINGUNGEN DES PROGRAMMS „REINE LUFT“
- 4 TÜRLATT-FALZE
- THERMO PREMIUM TÜRRAHMEN DUOTHERM / THERMO PRIME TÜRRAHMEN ALUTHERM PRIME
- VERSTELLBARE 3D-BÄNDER MIT BLENCEN IN DER FARBE DER BÄNDER
- WÄRMEISOLIERTE SCHWELLE
- BESCHLÄGE-SET MIT SCHLIESSZYLINDER-SCHUTZ
- TÜRROSETTEN BERGEN MIT TÜRDRÜCKERN ALEX
- SCHLIESSZYLINDER IN KLASSE 5, EIN-SCHLÜSSEL-SYSTEM FÜR TÜREN THERMO PREMIUM

• INSERTS **INOX** **SCHWARZ**

AUFPREISS

SONDERHÖHE (THERMO PRIME)	2150 - 2200 mm	✓
VERFÜGBARE FARBEN: FRP, FDE, FDW, FKG, FKF	2250 - 2300 mm	✓
	2350 - 2400 mm	✓
TÜRRAHMEN ALUTHERM PREMIUM (TÜREN THERMO PREMIUM)	✓	GRIFF AMSTERDAM / MONTREAL 1500 mm, EMPFOHLENE ELEKTROVERRIEGELUNG ✓
MASSE 100E	✓	GRIFF AMSTERDAM / MONTREAL 1000 mm, EMPFOHLENE ELEKTROVERRIEGELUNG ✓
RC3 PAKET	✓	GRIFF MIT DRÜCKER AMSTERDAM / MONTREAL 1500 mm MIT TÜRLATTANPASSUNG, ERFORDERLICHE ELEKTROVERRIEGELUNG ✓
TÜREN IN ZWEIFARBIGER AUSFÜHRUNG	✓	GRIFF MIT DRÜCKER AMSTERDAM / MONTREAL 1000 mm MIT TÜRLATTANPASSUNG, ERFORDERLICHE ELEKTROVERRIEGELUNG ✓
VERKÜRZUNG DER TÜREN (10, 20, 30, 40 mm)	✓	ELEKTROVERRIEGELUNG MIT TAG-/NACHT-FUNKTION ✓
SCHLIESSZYLINDER IN KLASSE 6 IM 1-SCHLÜSSEL-SYSTEM	✓	VERDECKT INSTALLIERTER TÜRSCHLIESSER ✓
SCHUTZ DER OBEREN TÜRROSETTE (THERMO PREMIUM)	✓	REED-RELAIS ✓
TÜRDRÜCKER/TÜRKNAUF	✓	SET TEDEE ✓
INSERT ZWEITE SEITE	✓	

* FIXE ALUMINIUM-SEITENLICHTER AUF SEITE 88-89, VOLLSTÄNDIGE LISTE MIT ZUBEHÖRTEILEN AUF SEITE 94-99

FARBEN DER TÜREN

ALPINE NUSSBAUM



FRR

MAHAGONI



FMA

BRAZILIAN NUSSBAUM



FRB

NUSSBAUM HELL



FRP

GOLDEICHE



FDE

WINCHESTER



FDW

LIGHT WENGE



FEJ

WEISS



FSB

STAHLGRAU



FKZ

ANTHRAZIT



FKG

ANTHRAZIT DUNKEL



FKF

SCHWARZ



FKC



KPC ERFURT 3



INNENSEITE

KONFIGURATION DER TÜR THERMO PRIME 75



KPA ERFURT 1



INNENSEITE

TÜRBSCHLÄGE

TÜRDRÜCKER-
-TÜRDRÜCKER



THERMO PRIME



THERMO PREMIUM

TÜRDRÜCKER-
-TÜRKNÄUF



THERMO PRIME



THERMO PREMIUM

GRIFF



□ AMSTERDAM
○ MONTREAL

FARBEN
DER BESCHLÄGE

ANODISIERSCHICHT
PLATINFARBEN



ANODISIERSCHICHT
SILBERN



ANODISIERSCHICHT
SCHWARZ



FARBEN DER TÜREN

ALPINE NUSSBAUM



FRR

MAHAGONI



FMA

BRAZILIAN NUSSBAUM



FRB

NUSSBAUM HELL



FRP

GOLDEICHE



FDE

WINCHESTER



FDW

LIGHT WENGE



FEJ

WEISS



FSB

STAHLGRAU



FKZ

ANTHRAZIT



FKG

ANTHRAZIT DUNKEL



FKF

SCHWARZ



FKC

ELITE 3D BRIG / OLTEN / VISP / TRIN / BERNO



ELA BRIG



ELB OLTEN

GRÖSSE	80	90N	90E	100E
--------	----	-----	-----	------

MODEL	THERMO PREMIUM 60	THERMO PREMIUM 75	THERM PRIME 75
ELA BRIG	✓	✓	✓
ELB OLTEN	✓	✓	✓
ELC VISP	✓	✓	✓
ELD TRIN	✓	✓	✓
ELE BERNO	✓	✓	✓

STANDARD AUSSTATTUNG RC2

- TÜRBLATT ERFÜLLT DIE BEDINGUNGEN DES PROGRAMMS „REINE LUFT“
- 4 TÜRBLATT-FALZE
- THERMO PREMIUM TÜRRAHMEN DUOTHERM / THERMO PRIME TÜRRAHMEN ALUTHERM PRIME
- VERSTELLBARE 3D-BÄNDER MIT BLENDEN IN DER FARBE DER BÄNDER
- WÄRMEISOLIERTE SCHWELLE
- BESCHLÄGE-SET MIT SCHLIESSZYLINDER-SCHUTZ
- TÜRROSETTEN BERGEN MIT TÜRDRÜCKERN ALEX
- SCHLIESSZYLINDER IN KLASSE 5, EIN-SCHLÜSSEL-SYSTEM FÜR TÜREN THERMO PREMIUM

AUFPREISS

SONDERHÖHE (THERMO PRIME)	2150 - 2200 mm	✓	
VERFÜGBARE FARBEN: FRP, FDE, FDW, FKG, FKF	2250 - 2300 mm	✓	
	2350 - 2400 mm	✓	
TÜRRAHMEN ALUTHERM PREMIUM (TÜREN THERMO PREMIUM)	✓	TÜRDRÜCKER/TÜRKNAUFL	✓
MASSE 100E	✓	VERDECKT INSTALLIERTER TÜRSCHLIESSER	✓
RC3 PAKET	✓	REED-RELAIS	✓
VERKÜRZUNG DER TÜREN (10, 20, 30, 40 mm)	✓	ELEKTROVERRIEGELUNG MIT TAG-/NACHT-FUNKTION	✓
TÜREN IN ZWEIFARBIGER AUSFÜHRUNG	✓	RAHMEN ANDERE SEITE	✓
SCHLIESSZYLINDER IN KLASSE 6 IM 1-SCHLÜSSEL-SYSTEM	✓	SET TEDEE	✓
SCHUTZ DER OBEREN TÜRROSETTE	✓		

* FIXE ALUMINIUM-SEITENLICHTER AUF SEITE 88-89, VOLLSTÄNDIGE LISTE MIT ZUBEHÖRTEILEN AUF SEITE 94-99

RAHMEN



CLASSIC LEISTE



MODERN LEISTE

FARBEN DER TÜREN

ALPINE NUSSBAUM



LIGHT WENGE



MAHAGONI



WEISS



BRAZILIAN NUSSBAUM



STAHLGRAU



NUSSBAUM HELL



ANTHRAZIT



GOLDEICHE



ANTHRAZIT DUNKEL



WINCHESTER



SCHWARZ



GERDA® ELITE 3D BRIG / OLTEN / VISP / TRIN / BERNO



ELC VISP



ELD TRIN



ELE BERNO

KONFIGURATION DER TÜR THERMO PRIME 75



ELA BRIG



INNENSEITE

TÜRBSCHLÄGE

TÜRDRÜCKER-
TÜRDRÜCKER



THERMO PRIME



THERMO PREMIUM

TÜRDRÜCKER-
TÜRKNAUF



THERMO PRIME



THERMO PREMIUM

FARBEN DER BESCHLÄGE

ANODISIERSCICHT
PLATINFARBEN



ANODISIERSCICHT
SILBERN



ANODISIERSCICHT
SCHWARZ



FARBEN DER TÜREN

ALPINE NUSSBAUM



FRR

MAHAGONI



FMA

BRAZILIAN NUSSBAUM



FRB

NUSSBAUM HELL



FRP

GOLDEICHE



FDE

WINCHESTER



FDW

LIGHT WENGE



FEJ

WEISS



FSB

STAHLGRAU



FKZ

ANTHRAZIT



FKG

ANTHRAZIT DUNKEL



FKF

SCHWARZ



FKC



NS1B MILANO 8 B



NS2 MILANO 9

GRÖSSE (THERMO PRIME, THERMO PREMIUM)	-	80	90N	90E	100E
GRÖSSE OPTIMA	80N	80	90N	90E	100E

MODEL	OPTIMA 60	THERMO PREMIUM 60	THERMO PREMIUM 75	THERMO PRIME 75
NS1/NS1B MILANO 8	✓	✓	✓	✓
NS2/NS2B MILANO 9	✓	✓	✓	✓
NS3/NS3B MILANO 10	✓	✓	✓	✓
NS4/NS4B MILANO 11	✓	✓	✓	✓
NS9/NS9B MILANO 12	✓	✓	✓	✓

STANDARD AUSSTATTUNG RC2

- TÜRBLATT VERGLAST, ERFÜLLT DIE BEDINGUNGEN DES PROGRAMMS „REINE LUFT“
- ALUMINIUM SCHWELLE
- 4 TÜRBLATT-FALZE THERMO PREMIUM UND THERMO PRIME, 3 TÜRBLATT-FALZE OPTIMA
- BESCHLÄGE-SET MIT SCHLIESSZYLINDER-SCHUTZ
- THERMO PREMIUM TÜRRAHMEN DUOTHERM / THERMO PRIME TÜRRAHMEN ALUTHERM PRIME / OPTIMA PERFOTHERM TÜRZARGE
- LANGE TÜRROSETTEN BERGEN THERMO PREMIUM, GETEILTE TÜRROSETTEN BERGEN THERMO PRIME, GETEILTE TÜRROSETTEN BLOCK OPTIMA
- VERSTELLBARE 3D-BÄNDER MIT BLENDCEN IN DER FARBE DER BÄNDER THERMO PREMIUM UND THERMO PRIME, 2D-BÄNDER MIT BLENDCEN IN DER FARBE DER BÄNDER OPTIMA
- SCHLIESSZYLINDER IN KLASSE 5 IM 1-SCHLÜSSEL-SYSTEM FÜR TÜREN THERMO PREMIUM UND OPTIMA
- ZWEISEITIGES DESIGN

AUFPREISS

SONDERHÖHE (THERMO PRIME)	2150 - 2200 mm	✓	
VERFÜGBARE FARBEN: FRP, FDE, FDW, FKG, FKF	2250 - 2300 mm	✓	
	2350 - 2400 mm	✓	
TÜRRAHMEN ALUTHERM PREMIUM (TÜREN THERMO PREMIUM)	✓	GRIFF AMSTERDAM / MONTREAL 1500 mm, EMPFOHLENE ELEKTROVERRIEGELUNG	✓
MASSE 100E	✓	GRIFF AMSTERDAM / MONTREAL 1000 mm, EMPFOHLENE ELEKTROVERRIEGELUNG	✓
VERKÜRZUNG DER TÜREN NS1, NS2, NS3, NS9, (10, 20, 30, 40 mm), NS4 (10, 20, 30, 40, 60, 80, 100 mm)	✓	GRIFF MIT DRÜCKER AMSTERDAM / MONTREAL 1500 mm MIT TÜRBLATTANPASSUNG, ERFORDERLICHE ELEKTROVERRIEGELUNG	✓
TÜREN IN ZWEIFARBIGER AUSFÜHRUNG	✓	GRIFF MIT DRÜCKER AMSTERDAM / MONTREAL 1000 mm MIT TÜRBLATTANPASSUNG, ERFORDERLICHE ELEKTROVERRIEGELUNG	✓
SCHLIESSZYLINDER IN KLASSE 6 IM 1-SCHLÜSSEL-SYSTEM	✓	ELEKTROVERRIEGELUNG MIT TAG-/NACHT-FUNKTION	✓
SCHUTZ DER OBEREN TÜRROSETTE (THERMO PREMIUM, OPTIMA)	✓	VERDECKT INSTALLIERTER TÜRSCHLIESSER	✓
TÜRDRÜCKER/TÜRKNAUF	✓	REED-RELAIS	✓
		SET TEDEE	✓

* FIXE ALUMINIUM-SEITENLICHTER AUF SEITE 88-89, VOLLSTÄNDIGE LISTE MIT ZUBEHÖRTEILEN AUF SEITE 94-99

SCHEIBEN



MATT

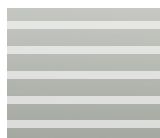

MATT,
TRANSPARENTER
STREIFEN



MIRA STAR
(SPIEGELGLAS)

FARBEN DER TÜREN

ALPINE NUSSBAUM



FRR

MAHAGONI



FMA

BRAZILIAN NUSSBAUM



FRB

NUSSBAUM HELL



FRP

GOLDEICHE



FDE

WINCHESTER



FDW

LIGHT WENGE



FEJ

WEISS



FSB

STAHLGRAU



FKZ

ANTHRAZIT



FKG

ANTHRAZIT DUNKEL



FKF

SCHWARZ



FKC



NS3 MILANO 10



NS4 MILANO 11



NS9 MILANO 12

KONFIGURATION DER TÜR THERMO PRIME 75



NS1B MILANO 8 B



INNENSEITE

TÜRBSCHLÄGE

TÜRDRÜCKER-
TÜRDRÜCKER



THERMO PRIME



THERMO PREMIUM



OPTIMA

TÜRDRÜCKER-
TÜRKNÄUF



THERMO PREMIUM

GRIFF

1000 mm
1500 mm

AMSTERDAM

MONTREAL

FARBEN
DER BESCHLÄGE

ANODISIERSCSCHICHT
PLATINFARBEN



ANODISIERSCSCHICHT
SILBERN



ANODISIERSCSCHICHT
SCHWARZ



FARBEN DER TÜREN

ALPINE NUSSBAUM



MAHAGONI



BRAZILIAN NUSSBAUM



NUSSBAUM HELL



GOLDEICHE



WINCHESTER



LIGHT WENGE



WEISS



STAHLGRAU



ANTHRAZIT



ANTHRAZIT DUNKEL



SCHWARZ





NS5B HANOVER 5 B



NS6 HANOVER 6

GRÖSSE (THERMO PRIME, THERMO PREMIUM)	-	80	90N	90E	100E
GRÖSSE OPTIMA	80N	80	90N	90E	100E

MODEL	OPTIMA 60	THERMO PREMIUM 60	THERMO PREMIUM 75	THERMO PRIME 75
NS5 HANOVER 5 B	✓	✓	✓	✓
NS6 HANOVER 6	✓	✓	✓	✓
NS7 INNSBRUCK	✓	✓	✓	✓

STANDARD AUSSTATTUNG RC2

- TÜRBLATT VERGLAST, ERFÜLLT DIE BEDINGUNGEN DES PROGRAMMS „REINE LUFT“
- 4 TÜRBLATT-FALZE THERMO PREMIUM UND THERMO PRIME, 3 TÜRBLATT-FALZE OPTIMA
- THERMO PREMIUM TÜRRAHMEN DUOTHERM / THERMO PRIME TÜRRAHMEN ALUTHERM PRIME / OPTIMA TÜRZARGE PERFOTHERM
- VERSTELLBARE 3D-BÄNDER MIT BLENDCEN IN DER FARBE DER BÄNDER THERMO PREMIUM UND THERMO PRIME, 2D-BÄNDER MIT BLENDCEN IN DER FARBE DER BÄNDER OPTIMA
- ZWEISEITIGES DESIGN
- ALUMINIUM SCHWELLE
- BESCHLÄGE-SET MIT SCHLIESSZYLINDER-SCHUTZ
- LANGE TÜRROSETTEN BERGEN THERMO PREMIUM, GETEILTE TÜRROSETTEN BERGEN THERMO PRIME, GETEILTE TÜRROSETTEN BLOCK OPTIMA
- SCHLIESSZYLINDER IN KLASSE 5 IM 1-SCHLÜSSEL-SYSTEM FÜR TÜREN THERMO PREMIUM UND OPTIMA

AUFPREISS

SONDERHÖHE (THERMO PRIME)	2150 - 2200 mm	✓
VERFÜGBARE FARBEN: FRP, FDE, FDW, FKG, FKF	2250 - 2300 mm	✓
	2350 - 2400 mm	✓
TÜRRAHMEN ALUTHERM PREMIUM (TÜREN THERMO PREMIUM)	✓	GRIFF AMSTERDAM / MONTREAL 1500 mm, EMPFOHLENE ELEKTROVERRIEGELUNG
MASSE 100E	✓	GRIFF AMSTERDAM / MONTREAL 1000 mm, EMPFOHLENE ELEKTROVERRIEGELUNG
VERKÜRZUNG DER TÜREN NS5 (10, 20, 30, 40, 60, 80, 100 mm), NS6 (10, 20, 30, 40 mm)	✓	GRIFF MIT DRÜCKER AMSTERDAM / MONTREAL 1500 mm MIT TÜRBLATTANPASSUNG, ERFORDERLICHE ELEKTROVERRIEGELUNG
TÜREN IN ZWEIFARBIGER AUSFÜHRUNG	✓	GRIFF MIT DRÜCKER AMSTERDAM / MONTREAL 1000 mm MIT TÜRBLATTANPASSUNG, ERFORDERLICHE ELEKTROVERRIEGELUNG
SCHLIESSZYLINDER IN KLASSE 6 IM 1-SCHLÜSSEL-SYSTEM	✓	ELEKTROVERRIEGELUNG MIT TAG-/NACHT-FUNKTION
SCHUTZ DER OBEREN TÜRROSETTE (THERMO PREMIUM, OPTIMA)	✓	VERDECKT INSTALLIERTER TÜRSCHLIESSER
TÜRDRÜCKER/TÜRKNAUF	✓	REED-RELAIS
		SET TEDEE

* FIXE ALUMINIUM-SEITENLICHTER AUF SEITE 88-89, VOLLSTÄNDIGE LISTE MIT ZUBEHÖRTEILEN AUF SEITE 94-99

SCHEIBEN



MATT



MIRA STAR (SPIEGELGLAS)

FARBEN DER TÜREN

ALPINE NUSSBAUM



FRR

MAHAGONI



FMA

BRAZILIAN NUSSBAUM



FRB

NUSSBAUM HELL



FRP

GOLDEICHE



FDE

WINCHESTER



FDW

LIGHT WENGE



FEJ

WEISS



FSB

STAHLGRAU



FKZ

ANTHRAZIT



FKG

ANTHRAZIT DUNKEL



FKF

SCHWARZ



FKC



NS7 INNSBRUCK

KONFIGURATION DER TÜR THERMO PRIME 75



NS5B HANOVER 5 B



INNENSEITE

TÜRBSCHLÄGE

TÜRDRÜCKER-
TÜRDRÜCKER



THERMO PRIME



THERMO PREMIUM



OPTIMA

TÜRDRÜCKER-
TÜRKNÄUF



THERMO PREMIUM

GRIFF



AMSTERDAM

MONTREAL

FARBEN
DER BESCHLÄGE

ANODISIERSCHEIT
PLATINFARBEN



ANODISIERSCHEIT
SILBERN



ANODISIERSCHEIT
SCHWARZ



FARBEN DER TÜREN

ALPINE NUSSBAUM



MAHAGONI



BRAZILIAN NUSSBAUM



NUSSBAUM HELL



GOLDEICHE



WINCHESTER



LIGHT WENGE



WEISS



STAHLGRAU



ANTHRAZIT



ANTHRAZIT DUNKEL



SCHWARZ





W00 FLACH

GRÖSSE (THERMO PRIME, THERMO PREMIUM)	-	80	90N	90E	100E
GRÖSSE OPTIMA	80N	80	90N	90E	100E

MODEL	OPTIMA 50	OPTIMA 60	THERMO PREMIUM 60	THERMO PREMIUM 75	THERMO PRIME 75
W00 FLACH	✓	✓	✓	✓	✓

STANDARD AUSSTATTUNG RC2

- TÜRLATT, ERFÜLLT DIE BEDINGUNGEN DES PROGRAMMS „REINE LUFT“
- ALUMINIUM SCHWELLE
- 4 TÜRLATT-FALZE THERMO PREMIUM UND THERMO PRIME, 3 TÜRLATT-FALZE OPTIMA
- BESCHLÄGE-SET MIT SCHLIESSZYLINDER-SCHUTZ
- THERMO PREMIUM TÜRZARGE DUOTHERM / THERMO PRIME TÜRZARGE ALUTHERM PRIME / OPTIMA 60 PERFOTHERM / OPTIMA 50 STAHL-TÜRRAHMEN
- LANGE TÜRROSETTEN BERGEN THERMO PREMIUM, GETEILTE TÜRROSETTEN BERGEN THERMO PRIME, GETEILTE TÜRROSETTEN BLOCK OPTIMA
- VERSTELLBARE 3D-BÄNDER MIT BLENDCEN IN DER FARBE DER BÄNDER THERMO PREMIUM UND THERMO PRIME, 2D-BÄNDER MIT BLENDCEN IN DER FARBE DER BÄNDER OPTIMA
- SCHLIESSZYLINDER IN KLASSE 5 IM 1-SCHLÜSSEL-SYSTEM FÜR TÜREN THERMO PREMIUM UND OPTIMA

AUFPREISS

SONDERHÖHE (THERMO PRIME)	2150 - 2200 mm	✓
VERFÜGBARE FARBEN: FRP, FDE, FDW, FKG, FKF	2250 - 2300 mm	✓
	2350 - 2400 mm	✓
TÜRRAHMEN ALUTHERM PREMIUM (TÜREN THERMO PREMIUM) / ALUTHERM (OPTIMA 60)	✓ GRIFF AMSTERDAM / MONTREAL 1500 mm	✓
TÜRRAHMEN OPTIMA 50 PERFOTHERM	✓ GRIFF AMSTERDAM / MONTREAL 1000 mm	✓
MASSE 100E	✓ GRIFF MIT DRÜCKER AMSTERDAM / MONTREAL 1500 mm MIT TÜRLATTANPASSUNG, ERFORDERLICHE ELEKTROVERRIEGELUNG	✓
RC3 PAKET	✓ GRIFF MIT DRÜCKER AMSTERDAM / MONTREAL 1000 mm MIT TÜRLATTANPASSUNG, ERFORDERLICHE ELEKTROVERRIEGELUNG	✓
VERKÜRZUNG DER TÜREN (10, 20, 30, 40, 60, 80, 100 mm)	✓ ELEKTROVERRIEGELUNG MIT TAG-/NACHT-FUNKTION	✓
TÜREN IN ZWEIFARBIGER AUSFÜHRUNG	✓ VERDECKT INSTALLIERTER TÜRSCHLIESSER (THERMO PRIME, THERMO PREMIUM)	✓
SCHLIESSZYLINDER IN KLASSE 6 IM 1-SCHLÜSSEL-SYSTEM	✓ REED-RELAIS	✓
SCHUTZ DER OBEREN TÜRROSETTE (THERMO PREMIUM, OPTIMA)	✓ TÜRDRÜCKER/TÜRKNAUF	✓
	SET TEDEE	✓

* FIXE ALUMINIUM-SEITENLICHTER AUF SEITE 88-89, VOLLSTÄNDIGE LISTE MIT ZUBEHÖRTEILEN AUF SEITE 94-99

FARBEN DER TÜREN

ALPINE NUSSBAUM



FRR

MAHAGONI



FMA

BRAZILIAN NUSSBAUM



FRB

NUSSBAUM HELL



FRP

GOLDEICHE



FDE

WINCHESTER



FDW

LIGHT WENGE



FEJ

WEISS



FSB

STAHLGRAU



FKZ

ANTHRAZIT



FKG

ANTHRAZIT DUNKEL



FKF

SCHWARZ



FKC



WOO FLACH



INNENSEITE

KONFIGURATION DER TÜR THERMO PRIME 75



WOO FLACH



INNENSEITE

TÜRBSCHLÄGE

TÜRDRÜCKER-
TÜRDRÜCKER



THERMO PRIME



THERMO PREMIUM



OPTIMA

TÜRDRÜCKER-
TÜRKNÄUF



THERMO PREMIUM

GRIFF

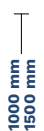

- AMSTERDAM
- MONTREAL

FARBEN
DER BESCHLÄGE

ANODISIERSCHICHT
PLATINFARBEN



ANODISIERSCHICHT
SILBERN



ANODISIERSCHICHT
SCHWARZ



FARBEN DER TÜREN

ALPINE NUSSBAUM



MAHAGONI



BRAZILIAN NUSSBAUM



NUSSBAUM HELL



GOLDEICHE



WINCHESTER



LIGHT WENGE



WEISS



STAHLGRAU



ANTHRAZIT



ANTHRAZIT DUNKEL



SCHWARZ





SNU MILANO 4



SNUA MILANO 4A

GRÖSSE

80N	80	90N	90E	100E
-----	----	-----	-----	------

MODEL

OPTIMA 50

OPTIMA 60

SNU MILANO 4

-

✓

SNUA MILANO 4A

-

✓

SNUB MILANO 4B

-

✓

STANDARD AUSSTATTUNG RC2

- | | |
|--|---|
| • TÜRLATT VERGLAST, ERFÜLLT DIE BEDINGUNGEN DES PROGRAMMS „REINE LUFT“ | • ALUMINIUM SCHWELLE |
| • 3 TÜRLATT-FALZE | • BESCHLÄGE-SET MIT SCHLISSZYLINDER-SCHUTZ |
| • OPTIMA 60 TÜRRAHMEN PERFOTHERM | • GETEILTE TÜRROSETTEN BERGEN UND BLOK |
| • 2D-BÄNDER MIT BLENDE IN DER FARBE DER BÄNDER | • SCHLISSZYLINDER IN KLASSE 5 IM 1-SCHLÜSSEL-SYSTEM |
| • ZWEISEITIGES DESIGN | |

AUFPREISS

TÜRZARGE ALUTHERM OPTIMA	✓	GRIF AMSTERDAM / MONTREAL 1500 mm, EMPFOHLENE ELEKTROVERRIEGELUNG	✓
MASSE 100E	✓	GRIF AMSTERDAM / MONTREAL 1000 mm, EMPFOHLENE ELEKTROVERRIEGELUNG	✓
VERKÜRZUNG DER TÜREN (10, 20, 30, 40, 60, 80, 100 mm)	✓	GRIF MIT DRÜCKER AMSTERDAM / MONTREAL 1500 mm MIT TÜRLATTANPASSUNG, ERFORDERLICHE ELEKTROVERRIEGELUNG	✓
TÜREN IN ZWEIFARBIGER AUSFÜHRUNG	✓	GRIF MIT DRÜCKER AMSTERDAM / MONTREAL 1000 mm MIT TÜRLATTANPASSUNG, ERFORDERLICHE ELEKTROVERRIEGELUNG	✓
SCHLISSZYLINDER IN KLASSE 6 IM 1-SCHLÜSSEL-SYSTEM	✓	ELEKTROVERRIEGELUNG MIT TAG-/NACHT-FUNKTION	✓
SCHUTZ DER OBEREN TÜRROSETTE	✓	REED-RELAIS	✓
TÜRDRÜCKER/TÜRKNÄUF	✓	SET TEDEE	✓

* FIXE ALUMINIUM-SEITENLICHTER AUF SEITE 88-89, VOLLSTÄNDIGE LISTE MIT ZUBEHÖRTEILEN AUF SEITE 94-99

SCHEIBEN



MATT



MATTE, TRANSPARENTER STREIFEN



GRAFIT



MIRA STAR (SPIEGELGLAS)

FARBEN DER TÜREN

ALPINE NUSSBAUM

FRR

MAHAGONI

FMA

BRAZILIAN NUSSBAUM

FRB

NUSSBAUM HELL

FRP

GOLDEICHE

FDE

WINCHESTER

FDW

LIGHT WENGE

FEJ

WEISS

FSB

STAHLGRAU

FKZ

ANTHRAZIT

FKG

ANTHRAZIT DUNKEL

FKF

SCHWARZ

FKC



SNUB MILANO 4B

TÜRBSCHLÄGE

TÜRDRÜCKER-
-TÜRDRÜCKER



TÜRDRÜCKER-
-TÜRKNÄUF



GRIFF



- AMSTERDAM
- MONTREAL

FARBEN
DER BESCHLÄGE

ANODISIERSCHICHT
PLATINFARBEN



ANODISIERSCHICHT
SILBERN



ANODISIERSCHICHT
SCHWARZ



FARBEN DER TÜREN

ALPINE NUSSBAUM



MAHAGONI



BRAZILIAN NUSSBAUM



NUSSBAUM HELL



GOLDEICHE



WINCHESTER



LIGHT WENGE



WEISS



STAHLGRAU



ANTHRAZIT



ANTHRAZIT DUNKEL



SCHWARZ





NT1 TURYN 1



NT1B TURYN 1B

GRÖSSE	80N	80	90N	90E	100E
--------	-----	----	-----	-----	------

MODEL	OPTIMA 50	OPTIMA 60
NT1 TURYN 1	-	✓
NT1B TURYN 1B	-	✓
NT2 TURYN 2	-	✓
NT2B TURYN 2B	-	✓

STANDARD AUSSTATTUNG RC2

• TÜRLATT VERGLAST, ERFÜLLT DIE BEDINGUNGEN DES PROGRAMMS „REINE LUFT“	• ALUMINIUM SCHWELLE
• 3 TÜRLATT-FALZE	• BESCHLÄGE-SET MIT SCHLIESSZYLINDER-SCHUTZ
• OPTIMA 60 TÜRRAHMEN PERFO THERM	• GETEILTE TÜRRÖSETTEN BERGEN UND BLOK
• 2D-BÄNDER MIT BLENDE IN DER FARBE DER BÄNDER	• SCHLIESSZYLINDER IN KLASSE 5 IM 1-SCHLÜSSEL-SYSTEM
• ZWEISEITIGES DESIGN	

AUFPREISS

TÜRZARGE ALUTHERM OPTIMA	✓	GRIFF AMSTERDAM / MONTREAL 1500 mm, EMPFOHLENE ELEKTROVERRIEGELUNG	✓
MASSE 100E	✓	GRIFF AMSTERDAM / MONTREAL 1000 mm, EMPFOHLENE ELEKTROVERRIEGELUNG	✓
VERKÜRZUNG DER TÜREN (10, 20, 30, 40 mm)	✓	GRIFF MIT DRÜCKER AMSTERDAM / MONTREAL 1500 mm MIT TÜRLATTANPASSUNG, ERFORDERLICHE ELEKTROVERRIEGELUNG	✓
TÜREN IN ZWEIFARBIGER AUSFÜHRUNG	✓	GRIFF MIT DRÜCKER AMSTERDAM / MONTREAL 1000 mm MIT TÜRLATTANPASSUNG, ERFORDERLICHE ELEKTROVERRIEGELUNG	✓
SCHLIESSZYLINDER IN KLASSE 6 IM 1-SCHLÜSSEL-SYSTEM	✓	ELEKTROVERRIEGELUNG MIT TAG-/NACHT-FUNKTION	✓
SCHUTZ DER OBEREN TÜRRÖSETTE	✓	REED-RELAIS	✓
TÜRDRÜCKER/TÜRKNÄUF	✓	SET TEDEE	✓

* FIXE ALUMINIUM-SEITENLICHTER AUF SEITE 88-89, VOLLSTÄNDIGE LISTE MIT ZUBEHÖRTEILEN AUF SEITE 94-99

SCHEIBEN



MATT



MATTE, TRANSPARENT E STREIFEN



GRAFIT



MIRA STAR (SPIEGELGLAS)

FARBEN DER TÜREN

ALPINE NUSSBAUM



FRR

MAHAGONI



FMA

BRAZILIAN NUSSBAUM



FRB

NUSSBAUM HELL



FRP

GOLDEICHE



FDE

WINCHESTER



FDW

LIGHT WENGE



FEJ

WEISS



FSB

STAHLGRAU



FKZ

ANTHRAZIT



FKG

ANTHRAZIT DUNKEL



FKF

SCHWARZ



FKC



NT2 TURYN 2



NT2B TURYN 2B

TÜRBSCHLÄGE

TÜRDRÜCKER-
-TÜRDRÜCKER



TÜRDRÜCKER-
-TÜRKNÄUF



GRIFF



- AMSTERDAM
- MONTREAL

FARBEN
DER BESCHLÄGE

ANODISIERSCHICHT
PLATINFARBEN



ANODISIERSCHICHT
SILBERN



ANODISIERSCHICHT
SCHWARZ



FARBEN DER TÜREN

ALPINE NUSSBAUM



FRR

MAHAGONI



FMA

BRAZILIAN NUSSBAUM



FRB

NUSSBAUM HELL



FRP

GOLDEICHE



FDE

WINCHESTER



FDW

LIGHT WENGE



FEJ

WEISS



FSB

STAHLGRAU



FKZ

ANTHRAZIT



FKG

ANTHRAZIT DUNKEL



FKF

SCHWARZ



FKC

TEMPO

BERGAMO / NICEA / BERLIN



SOJ BERGAMO 2



SJ9 NICEA 9

GRÖSSE	80N	80	90N	90E	100E
--------	-----	----	-----	-----	------

MODEL	OPTIMA 50	OPTIMA 60
SOJ BERGAMO 2	-	✓
SJ9 NICEA 9	-	✓
SBE BERLIN	-	✓

STANDARDAUSSTATTUNG RC2

- TÜRLATT VERGLAST, ERFÜLLT DIE BEDINGUNGEN DES PROGRAMMS „REINE LUFT“
- 3 TÜRLATT-FALZE
- OPTIMA 60 TÜRRAHMEN PERFOTHERM
- 2D-BÄNDER MIT BLENDEN IN DER FARBE DER BÄNDER
- ZWEISEITIGES DESIGN
- ALUMINIUM SCHWELLE
- BESCHLÄGE-SET MIT SCHLISSZYLINDER-SCHUTZ
- GETEILTE TÜRROSETTEN BERGEN UND BLOK
- SCHLISSZYLINDER IN KLASSE 5 IM 1-SCHLÜSSEL-SYSTEM

AUFPREISS

TÜRZARGE ALUTHERM OPTIMA	✓	GRIFF AMSTERDAM / MONTREAL 1500 mm, EMPFOHLENE ELEKTROVERRIEGELUNG	✓
MASSE 100E	✓	GRIFF AMSTERDAM / MONTREAL 1000 mm, EMPFOHLENE ELEKTROVERRIEGELUNG	✓
VERKÜRZUNG DER TÜREN SOJ (10, 20, 30, 40 mm) SJ9, SBE (10, 20, 30, 40, 60, 80, 100 mm)	✓	GRIFF MIT DRÜCKER AMSTERDAM / MONTREAL 1500 mm MIT TÜRLATTANPASSUNG, ERFORDERLICHE ELEKTROVERRIEGELUNG	✓
TÜREN IN ZWEIFARBIGER AUSFÜHRUNG	✓	GRIFF MIT DRÜCKER AMSTERDAM / MONTREAL 1000 mm MIT TÜRLATTANPASSUNG, ERFORDERLICHE ELEKTROVERRIEGELUNG	✓
SCHLISSZYLINDER IN KLASSE 6 IM 1-SCHLÜSSEL-SYSTEM	✓	ELEKTROVERRIEGELUNG MIT TAG-/NACHT-FUNKTION	✓
SCHUTZ DER OBEREN TÜRROSETTE	✓	REED-RELAIS	✓
TÜRDRÜCKER/TÜRKNAUF	✓	SET TEDEE	✓

* FIXE ALUMINIUM-SEITENLICHTER AUF SEITE 88-89, VOLLSTÄNDIGE LISTE MIT ZUBEHÖRTEILEN AUF SEITE 94-99

SCHEIBEN (BERGAMO / NICEA)



MATT

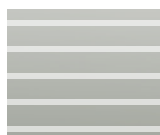

MATTE,
TRANSPARENT
STREIFEN



MIRA STAR
(SPIEGELGLAS)

FARBEN DER TÜREN

ALPINE NUSSBAUM



FRR

MAHAGONI



FMA

BRAZILIAN NUSSBAUM



FRB

NUSSBAUM HELL



FRP

GOLDEICHE



FDE

WINCHESTER



FDW

LIGHT WENGE



FEJ

WEISS



FSB

STAHLGRAU



FKZ

ANTHRAZIT



FKG

ANTHRAZIT DUNKEL



FKF

SCHWARZ



FKC



SBE BERLIN

SCHEIBEN (BERLIN)



MATT



REFLEX BRONZE

FARBEN DER TÜREN

ALPINE NUSSBAUM



FRR

MAHAGONI



FMA

BRAZILIAN NUSSBAUM



FRB

NUSSBAUM HELL



FRP

GOLDEICHE



FDE

WINCHESTER



FDW

LIGHT WENGE



FEJ

WEISS



FSB

STAHLGRAU



FKZ

ANTHRAZIT



FKG

ANTHRAZIT DUNKEL



FKF

SCHWARZ



FKC

TÜRBSCHLÄGE

TÜRDRÜCKER- -TÜRDRÜCKER



TÜRDRÜCKER- -TÜRKNÄUF



GRIFF



- AMSTERDAM
- MONTREAL

FARBEN DER BESCHLÄGE

ANODISIERSCHICHT PLATINFARBEN



ANODISIERSCHICHT SILBERN



ANODISIERSCHICHT SCHWARZ





ST4 UPPSALA 1
(Prägung ohne Inserts)



ST4A UPPSALA 1A (Inserts INOX)

GRÖSSE	80N	80	90N	90E	100E
--------	-----	----	-----	-----	------

MODEL	OPTIMA 50	OPTIMA 60
ST4 UPPSALA 1	✓	✓
ST4A UPPSALA 1A	✓	✓
ST5 UPPSALA 2	✓	✓
ST5A UPPSALA 2A	✓	✓

STANDARDAUSSTATTUNG RC2

- TÜRLATT VERGLAST, ERFÜLLT DIE BEDINGUNGEN DES PROGRAMMS „REINE LUFT“
- 3 TÜRLATT-FALZE
- OPTIMA 50 STAHL-TÜRRAHMEN, OPTIMA 60 TÜRRAHMEN PERFOTHERM
- 2D-BÄNDER MIT BLENDE IN DER FARBE DER BÄNDER
- ZWEISEITIGES DESIGN
- ALUMINIUM SCHWELLE
- BESCHLÄGE-SET MIT SCHLIESSZYLINDER-SCHUTZ
- GETEILTE TÜRROSETTEN BERGEN UND BLOK
- SCHLIESSZYLINDER IN KLASSE 5 IM 1-SCHLÜSSEL-SYSTEM

AUFPREISS

ALUTHERM OPTIMA TÜRZARGE (OPTIMA 60)	✓	GRIFF AMSTERDAM / MONTREAL 1500 MM, EMPFOHLENE ELEKTROVERRIEGELUNG	✓
PERFOTHERM STAHL-TÜRRAHMEN (OPTIMA 50)	✓	GRIFF AMSTERDAM / MONTREAL 1000 MM, EMPFOHLENE ELEKTROVERRIEGELUNG	✓
MASSE 100E	✓	GRIFF MIT DRÜCKER AMSTERDAM / MONTREAL 1500 mm MIT TÜRLATTANPASSUNG, ERFORDERLICHE ELEKTROVERRIEGELUNG	✓
RC3 PAKET	✓	GRIFF MIT DRÜCKER AMSTERDAM / MONTREAL 1000 mm MIT TÜRLATTANPASSUNG, ERFORDERLICHE ELEKTROVERRIEGELUNG	✓
VERKÜRZUNG DER TÜREN (10, 20, 30, 40 mm)	✓	ELEKTROVERRIEGELUNG MIT TAG-/NACHT-FUNKTION	✓
TÜREN IN ZWEIFARBIGER AUSFÜHRUNG	✓	REED-RELAIS	✓
SCHLIESSZYLINDER IN KLASSE 6 IM 1-SCHLÜSSEL-SYSTEM	✓	SET TEDEE	✓
SCHUTZ DER OBEREN TÜRROSETTE	✓		
TÜRDRÜCKER/TÜRKNAUF	✓		

* FIXE ALUMINIUM-SEITENLICHTER AUF SEITE 88-89, VOLLSTÄNDIGE LISTE MIT ZUBEHÖRTEILEN AUF SEITE 94-99

FARBEN DER TÜREN

ALPINE NUSSBAUM



FRR

MAHAGONI



FMA

BRAZILIAN NUSSBAUM



FRB

NUSSBAUM HELL



FRP

GOLDEICHE



FDE

WINCHESTER



FDW

LIGHT WENGE



FEJ

WEISS



FSB

STAHLGRAU



FKZ

ANTHRAZIT



FKG

ANTHRAZIT DUNKEL



FKF

SCHWARZ



FKC



ST5 UPPSALA 2
(Prägung ohne Inserts)



ST5A UPPSALA 2A (Inserts INOX)

TÜRBSCHLÄGE

TÜRDRÜCKER-
-TÜRDRÜCKER



TÜRDRÜCKER-
-TÜRKNÄUF



GRIFF



- AMSTERDAM
- MONTREAL

FARBEN
DER BESCHLÄGE

ANODISIERSCHICHT
PLATINFARBEN



ANODISIERSCHICHT
SILBERN



ANODISIERSCHICHT
SCHWARZ



FARBEN DER TÜREN

ALPINE NUSSBAUM



MAHAGONI



BRAZILIAN NUSSBAUM



NUSSBAUM HELL



GOLDEICHE



WINCHESTER



LIGHT WENGE



WEISS



STAHLGRAU



ANTHRAZIT



ANTHRAZIT DUNKEL



SCHWARZ





TML TOKIO 1
(Prägung ohne Inserts)



TMLA TOKIO 1A (Inserts INOX)

GRÖSSE	80N	80	90N	90E	100E
--------	-----	----	-----	-----	------

MODEL	OPTIMA 50	OPTIMA 60
TML TOKIO 1	✓	✓
TMLA TOKIO 1A	✓	✓
TMm TOKIO 2	✓	✓
TMmA TOKIO 2A	✓	✓

STANDARD AUSSTATTUNG RC2

- TÜRLATT VERGLAST, ERFÜLLT DIE BEDINGUNGEN DES PROGRAMMS „REINE LUFT“
- 3 TÜRLATT-FALZE
- OPTIMA 50 STAHL-TÜRRAHMEN, OPTIMA 60 TÜRRAHMEN PERFOTHERM
- 2D-BÄNDER MIT BLENDE IN DER FARBE DER BÄNDER
- ZWEISEITIGES DESIGN
- ALUMINIUM SCHWELLE
- BESCHLÄGE-SET MIT SCHLIESSZYLINDER-SCHUTZ
- GETEILTE TÜRROSETTEN BERGEN UND BLOK
- SCHLIESSZYLINDER IN KLASSE 5 IM 1-SCHLÜSSEL-SYSTEM

AUFPREISS

ALUTHERM OPTIMA TÜRZARGE (OPTIMA 60)	✓	GRIFF AMSTERDAM / MONTREAL 1500 mm, EMPFOHLENE ELEKTROVERRIEGELUNG	✓
PERFOTHERM STAHL-TÜRRAHMEN (OPTIMA 50)	✓	GRIFF AMSTERDAM / MONTREAL 1000 mm, EMPFOHLENE ELEKTROVERRIEGELUNG	✓
MASSE 100E	✓	GRIFF MIT DRÜCKER AMSTERDAM / MONTREAL 1500 mm MIT TÜRLATTANPASSUNG, ERFORDERLICHE ELEKTROVERRIEGELUNG	✓
RC3 PAKET	✓	GRIFF MIT DRÜCKER AMSTERDAM / MONTREAL 1000 mm MIT TÜRLATTANPASSUNG, ERFORDERLICHE ELEKTROVERRIEGELUNG	✓
VERKÜRZUNG DER TÜREN (10, 20, 30, 40 mm)	✓	ELEKTROVERRIEGELUNG MIT TAG-/NACHT-FUNKTION	✓
TÜREN IN ZWEIFARBIGER AUSFÜHRUNG	✓	REED-RELAIS	✓
SCHLIESSZYLINDER IN KLASSE 6 IM 1-SCHLÜSSEL-SYSTEM	✓	SET TEDEE	✓
SCHUTZ DER OBEREN TÜRROSETTE	✓		
TÜRDRÜCKER/TÜRKNAUF	✓		

* FIXE ALUMINIUM-SEITENLICHTER AUF SEITE 88-89, VOLLSTÄNDIGE LISTE MIT ZUBEHÖRTEILEN AUF SEITE 94-99

FARBEN DER TÜREN

ALPINE NUSSBAUM



FRR

MAHAGONI



FMA

BRAZILIAN NUSSBAUM



FRB

NUSSBAUM HELL



FRP

GOLDEICHE



FDE

WINCHESTER



FDW

LIGHT WENGE



FEJ

WEISS



FSB

STAHLGRAU



FKZ

ANTHRAZIT



FKG

ANTHRAZIT DUNKEL



FKF

SCHWARZ



FKC



TMm TOKIO 2
(Prägung ohne Inserts)



TMmA TOKIO 2A (Inserts INOX)

TÜRBSCHLÄGE

TÜRDRÜCKER-
-TÜRDRÜCKER



TÜRDRÜCKER-
-TÜRKNAUF



GRIFF



- AMSTERDAM
- MONTREAL

FARBEN
DER BESCHLÄGE

ANODISIERSCHICHT
PLATINFARBEN



ANODISIERSCHICHT
SILBERN



ANODISIERSCHICHT
SCHWARZ



FARBEN DER TÜREN

ALPINE NUSSBAUM



FRR

MAHAGONI



FMA

BRAZILIAN NUSSBAUM



FRB

NUSSBAUM HELL



FRP

GOLDEICHE



FDE

WINCHESTER



FDW

LIGHT WENGE



FEJ

WEISS



FSB

STAHLGRAU



FKZ

ANTHRAZIT



FKG

ANTHRAZIT DUNKEL



FKF

SCHWARZ



FKC

TEMPO RYGA / LUND / ASPEN



ST8 RYGA



ST9 LUND

GRÖSSE	80N	80	90N	90E	100E
--------	-----	----	-----	-----	------

MODEL	OPTIMA 50	OPTIMA 60
ST8 RYGA	✓	✓
ST9 LUND	✓	✓
WBA ASPEN 1	✓	✓
TN7 ASPEN 2	✓	✓
TN7B ASPEN 2B	✓	✓

STANDARDAUSSTATTUNG RC2

- TÜRBLATT, ERFÜLLT DIE BEDINGUNGEN DES PROGRAMMS „REINE LUFT“
- 3 TÜRBLATT-FALZE
- OPTIMA 50 STAHL-TÜRRAHMEN, OPTIMA 60 TÜRRAHMEN PERFOTHERM
- 2D-BÄNDER MIT BLENDEN IN DER FARBE DER BÄNDER
- ZWEISEITIGES DESIGN
- ALUMINIUM SCHWELLE
- BESCHLÄGE-SET MIT SCHLIESSZYLINDER-SCHUTZ
- GETEILTE TÜRROSETTEN BERGEN UND BLOK
- SCHLIESSZYLINDER IN KLASSE 5 IM 1-SCHLÜSSEL-SYSTEM

AUFPREISS

ALUTHERM OPTIMA TÜRZARGE (OPTIMA 60)	✓	GRIFF AMSTERDAM / MONTREAL 1500 mm, EMPFOHLENE ELEKTROVERRIEGELUNG	✓
PERFOTHERM STAHL-TÜRRAHMEN (OPTIMA 50)	✓	GRIFF AMSTERDAM / MONTREAL 1000 mm, EMPFOHLENE ELEKTROVERRIEGELUNG	✓
MASSE 100E	✓	GRIFF MIT DRÜCKER AMSTERDAM / MONTREAL 1500 mm MIT TÜRBLATTANPASSUNG, ERFORDERLICHE ELEKTROVERRIEGELUNG	✓
RC3 PAKET	✓	GRIFF MIT DRÜCKER AMSTERDAM / MONTREAL 1000 mm MIT TÜRBLATTANPASSUNG, ERFORDERLICHE ELEKTROVERRIEGELUNG	✓
VERKÜRZUNG DER TÜREN WBA, TN7, TN7B (10, 20, 30, 40, 60, 80, 100 mm)	✓	ELEKTROVERRIEGELUNG MIT TAG-/NACHT-FUNKTION	✓
TÜREN IN ZWEIFARBIGER AUSFÜHRUNG	✓	REED-RELAIS	✓
SCHLIESSZYLINDER IN KLASSE 6 IM 1-SCHLÜSSEL-SYSTEM	✓	SET TEDEE	✓
SCHUTZ DER OBEREN TÜRROSETTE	✓		
TÜRDRÜCKER/TÜRKNÄUF	✓		

* FIXE ALUMINIUM-SEITENLICHTER AUF SEITE 88-89, VOLLSTÄNDIGE LISTE MIT ZUBEHÖRTEILEN AUF SEITE 94-99

FARBEN DER TÜREN

ALPINE NUSSBAUM



FRR

MAHAGONI



FMA

BRAZILIAN NUSSBAUM



FRB

NUSSBAUM HELL



FRP

GOLDEICHE



FDE

WINCHESTER



FDW

LIGHT WENGE



FEJ

WEISS



FSB

STAHLGRAU



FKZ

ANTHRAZIT



FKG

ANTHRAZIT DUNKEL



FKF

SCHWARZ



FKC



WBA ASPEN 1



TN7 ASPEN 2



TN7B ASPEN 2B

TÜR BESCHLÄGE

TÜRDRÜCKER-
-TÜRDRÜCKER



TÜRDRÜCKER-
-TÜRKNÄUF



GRIFF



- AMSTERDAM
- MONTREAL

FARBEN
DER BESCHLÄGE

ANODISIERSCHICHT
PLATINFARBEN



ANODISIERSCHICHT
SILBERN



ANODISIERSCHICHT
SCHWARZ



FARBEN DER TÜREN

ALPINE NUSSBAUM



MAHAGONI



BRAZILIAN NUSSBAUM



NUSSBAUM HELL



GOLDEICHE



WINCHESTER



LIGHT WENGE



WEISS



STAHLGRAU



ANTHRAZIT



ANTHRAZIT DUNKEL



SCHWARZ





SR3 TROMSO



SR4 TROMSO 1

GRÖSSE	80N	80	90N	90E	100E
--------	-----	----	-----	-----	------

MODEL	OPTIMA 50	OPTIMA 60
SR3 TROMSO	✓	✓
SR4 TROMSO 1	✓	✓
SR5 TROMSO 2	✓	✓

STANDARDAUSSTATTUNG RC2

- TÜRLATT, ERFÜLLT DIE BEDINGUNGEN DES PROGRAMMS „REINE LUFT“
- 3 TÜRLATT-FALZE
- OPTIMA 50 STAHL-TÜRRAHMEN, OPTIMA 60 TÜRRAHMEN PERFOTHERM
- 2D-BÄNDER MIT BLENDEN IN DER FARBE DER BÄNDER
- ZWEISEITIGES DESIGN
- ALUMINIUM SCHWELLE
- BESCHLÄGE-SET MIT SCHLIESSZYLINDER-SCHUTZ
- GETEILTE TÜRROSETTEN BERGEN UND BLOK
- SCHLIESSZYLINDER IN KLASSE 5 IM 1-SCHLÜSSEL-SYSTEM

AUFPREISS

ALUTHERM OPTIMA TÜRZARGE (OPTIMA 60)	✓	GRIFF AMSTERDAM / MONTREAL 1500 mm, EMPFOHLENE ELEKTROVERRIEGELUNG	✓
PERFOTHERM STAHL-TÜRRAHMEN (OPTIMA 50)	✓	GRIFF AMSTERDAM / MONTREAL 1000 mm, EMPFOHLENE ELEKTROVERRIEGELUNG	✓
MASSE 100E	✓	GRIFF MIT DRÜCKER AMSTERDAM / MONTREAL 1500 mm MIT TÜRLATTANPASSUNG, ERFORDERLICHE ELEKTROVERRIEGELUNG	✓
RC3 PAKET	✓	GRIFF MIT DRÜCKER AMSTERDAM / MONTREAL 1000 mm MIT TÜRLATTANPASSUNG, ERFORDERLICHE ELEKTROVERRIEGELUNG	✓
VERKÜRZUNG DER TÜREN SR4 (10, 20, 30, 40 mm)	✓	ELEKTROVERRIEGELUNG MIT TAG-/NACHT-FUNKTION	✓
TÜREN IN ZWEIFARBIGER AUSFÜHRUNG	✓	REED-RELAIS	✓
SCHLIESSZYLINDER IN KLASSE 6 IM 1-SCHLÜSSEL-SYSTEM	✓	SET TEDEE	✓
SCHUTZ DER OBEREN TÜRROSETTE	✓		
TÜRDRÜCKER/TÜRKNAUF	✓		

* FIXE ALUMINIUM-SEITENLICHTER AUF SEITE 88-89, VOLLSTÄNDIGE LISTE MIT ZUBEHÖRTEILEN AUF SEITE 94-99

FARBEN DER TÜREN

ALPINE NUSSBAUM



FRR

MAHAGONI



FMA

BRAZILIAN NUSSBAUM



FRB

NUSSBAUM HELL



FRP

GOLDEICHE



FDE

WINCHESTER



FDW

LIGHT WENGE



FEJ

WEISS



FSB

STAHLGRAU



FKZ

ANTHRAZIT



FKG

ANTHRAZIT DUNKEL



FKF

SCHWARZ



FKC



SR5 TROMSO 2

TÜRBSCHLÄGE

TÜRDRÜCKER-
-TÜRDRÜCKER



TÜRDRÜCKER-
-TÜRKNÄUF



GRIFF



- AMSTERDAM
- MONTREAL

FARBEN
DER BESCHLÄGE

ANODISIERSCHICHT
PLATINFARBEN



ANODISIERSCHICHT
SILBERN



ANODISIERSCHICHT
SCHWARZ



FARBEN DER TÜREN

ALPINE NUSSBAUM



FRR

MAHAGONI



FMA

BRAZILIAN NUSSBAUM



FRB

NUSSBAUM HELL



FRP

GOLDEICHE



FDE

WINCHESTER



FDW

LIGHT WENGE



FEJ

WEISS



FSB

STAHLGRAU



FKZ

ANTHRAZIT



FKG

ANTHRAZIT DUNKEL



FKF

SCHWARZ



FKC

CLASSIC MODENA / RAVENA

GERDA®



W76 MODENA



W77 MODENA 2

GRÖSSE	80	90N	90E
--------	----	-----	-----

MODEL	OPTIMA 50	OPTIMA 60
W76 MODENA	-	✓
W77 MODENA 2	-	✓
W78 MODENA 3	-	✓
WDR RAVENA	✓	✓

STANDARD AUSSTATTUNG RC2

• TÜRBLATT VERGLAST, ERFÜLLT DIE BEDINGUNGEN DES PROGRAMMS „REINE LUFT“	• ALUMINIUM SCHWELLE
• 3 TÜRBLATT-FALZE	• BESCHLÄGE-SET MIT SCHLIESSZYLINDER-SCHUTZ
• OPTIMA 50 STAHL-TÜRRAHMEN, OPTIMA 60 TÜRRAHMEN PERFOTHERM	• GETEILTE TÜRROSETTEN BERGEN UND BLOK
• 2D-BÄNDER MIT BLENDE IN DER FARBE DER BÄNDER	• SCHLIESSZYLINDER IN KLASSE 5 IM 1-SCHLÜSSEL-SYSTEM
• ZWEISEITIGES DESIGN	• TIEFE PRÄGUNG

AUFPREISS

ALUTHERM OPTIMA TÜRZARGE (OPTIMA 60)	✓	ELEKTROVERRIEGELUNG MIT TAG-/NACHT-FUNKTION	✓
PERFOTHERM STAHL-TÜRRAHMEN (OPTIMA 50)	✓	REED-RELAIS	✓
RC3 PAKET (OPTIMA 60 DESIGN WDR)	✓	SET TEDEE	✓
VERKÜRZUNG DER TÜREN (10, 20, 30, 40, 60, 80, 100 mm)	✓		
TÜREN IN ZWEIFARBIGER AUSFÜHRUNG	✓		
SCHLIESSZYLINDER IN KLASSE 6 IM 1-SCHLÜSSEL-SYSTEM	✓		
SCHUTZ DER OBEREN TÜRROSETTE	✓		
TÜRDRÜCKER/TÜRKNÄUF	✓		

* FIXE ALUMINIUM-SEITENLICHTER AUF SEITE 88-89, VOLLSTÄNDIGE LISTE MIT ZUBEHÖRTEILEN AUF SEITE 94-99

SCHEIBE



MATT



**REFLEX
BRONZE**



**MIRA STAR
(SPIEGELGLAS)**

FARBEN DER TÜREN

ALPINE NUSSBAUM



FRR

MAHAGONI



FMA

BRAZILIAN NUSSBAUM



FRB

NUSSBAUM HELL



FRP

GOLDEICHE



FDE

WINCHESTER



FDW

WEISS



FSB

STAHLGRAU



FKZ

ANTHRAZIT



FKG

ANTHRAZIT DUNKEL



FKF



W78 MODENA 3



WDR RAVENA

TÜRBSCHLÄGE

TÜRDRÜCKER-
-TÜRDRÜCKER



TÜRDRÜCKER-
-TÜRKNÄUF



FARBEN DER BESCHLÄGE

**ANODISIERSCHICHT
PLATINFARBEN**



**ANODISIERSCHICHT
SILBERN**



**ANODISIERSCHICHT
SCHWARZ**



FARBEN DER TÜREN

ALPINE NUSSBAUM



MAHAGONI



BRAZILIAN NUSSBAUM



NUSSBAUM HELL



GOLDEICHE



WINCHESTER



WEISS



STAHLGRAU



ANTHRAZIT



ANTHRAZIT DUNKEL





WJ1 NICEA 5

GRÖSSE	80	90N	90E
--------	----	-----	-----

MODEL	OPTIMA 50	OPTIMA 60
WJ1 NICEA 5	-	✓
W23 OLYMPIA	-	✓

STANDARD AUSSTATTUNG RC2

• TÜRLATT VERGLAST, ERFÜLLT DIE BEDINGUNGEN DES PROGRAMMS „REINE LUFT“	• ALUMINIUM SCHWELLE
• 3 TÜRLATT-FALZE	• BESCHLÄGE-SET MIT SCHLIESSZYLINDER-SCHUTZ
• OPTIMA 60 TÜRRAHMEN PERFOTHERM	• GETEILTE TÜRROSETTEN BERGEN UND BLOK
• 2D-BÄNDER MIT BLENDE IN DER FARBE DER BÄNDER	• SCHLIESSZYLINDER IN KLASSE 5 IM 1-SCHLÜSSEL-SYSTEM
• ZWEISEITIGES DESIGN	• TIEFE PRÄGUNG

AUFPREISS

ALUTHERM OPTIMA TÜRZARGE (OPTIMA 60)	✓	ELEKTROVERRIEGELUNG MIT TAG-/NACHT-FUNKTION	✓
PERFOTHERM STAHL-TÜRRAHMEN (OPTIMA 50)	✓	REED-RELAIS	✓
MASSE 100E (DESIGN W23)	✓	SET TEDEE	✓
VERKÜRZUNG DER TÜREN (10, 20, 30, 40, 60, 80, 100 mm)	✓		
TÜREN IN ZWEIFARBIGER AUSFÜHRUNG	✓		
SCHLIESSZYLINDER IN KLASSE 6 IM 1-SCHLÜSSEL-SYSTEM	✓		
SCHUTZ DER OBEREN TÜRROSETTE	✓		
TÜRDRÜCKER/TÜRKNAUF	✓		

* FIXE ALUMINIUM-SEITENLICHTER AUF SEITE 88-89, VOLLSTÄNDIGE LISTE MIT ZUBEHÖRTEILEN AUF SEITE 94-99

SCHEIBEN



MATT



GRAFIT



MIRA STAR (SPIEGELGLAS)

FARBEN DER TÜREN

ALPINE NUSSBAUM



FRR

MAHAGONI



FMA

BRAZILIAN NUSSBAUM



FRB

NUSSBAUM HELL



FRP

GOLDEICHE



FDE

WINCHESTER



FDW

WEISS



FSB

STAHLGRAU



FKZ

ANTHRAZIT



FKG

ANTHRAZIT DUNKEL



FKF



W23 OLYMPIA

TÜRBSCHLÄGE

TÜRDRÜCKER-
-TÜRDRÜCKER



TÜRDRÜCKER-
-TÜRKNÄUF



FARBEN DER BESCHLÄGE

ANODISIERSCHICHT
PLATINFARBEN



ANODISIERSCHICHT
SILBERN



ANODISIERSCHICHT
SCHWARZ



FARBEN DER TÜREN

ALPINE NUSSBAUM



MAHAGONI



BRAZILIAN NUSSBAUM



NUSSBAUM HELL



GOLDEICHE



WINCHESTER



WEISS



STAHLGRAU



ANTHRAZIT



ANTHRAZIT DUNKEL





W91 WERONA



W94 WERONA 1

GRÖSSE	80	90N	90E
--------	----	-----	-----

MODEL	OPTIMA 50	OPTIMA 60
W91 WERONA	✓	✓
W94 WERONA 1	-	✓
W93 WERONA 3	-	✓
W6A WERONA 4	-	✓
WQA WERONA 5	-	✓

STANDARD AUSSTATTUNG RC2

- TÜRLATT VERGLAST, ERFÜLLT DIE BEDINGUNGEN DES PROGRAMMS „REINE LUFT“
- 3 TÜRLATT-FALZE
- OPTIMA 50 STAHL-TÜRRAHMEN, OPTIMA 60 TÜRRAHMEN PERFOTHERM
- 2D-BÄNDER MIT BLENDE IN DER FARBE DER BÄNDER
- ZWEISEITIGES DESIGN
- ALUMINIUM SCHWELLE
- BESCHLÄGE-SET MIT SCHLIESSZYLINDER-SCHUTZ
- GETEILTE TÜRROSETTEN BERGEN UND BLOK
- SCHLIESSZYLINDER IN KLASSE 5 IM 1-SCHLÜSSEL-SYSTEM
- TIEFE PRÄGUNG

AUFPREISS

ALUTHERM OPTIMA TÜRZARGE (OPTIMA 60)	✓	ELEKTROVERRIEGELUNG MIT TAG-/NACHT-FUNKTION	✓
PERFOTHERM STAHL-TÜRRAHMEN (OPTIMA 50)	✓	REED-RELAIS	✓
RC3 PAKET (OPTIMA 60 DESIGN W91)	✓	SCHLIESSZYLINDER IN KLASSE 6 IM 1-SCHLÜSSEL-SYSTEM	✓
VERKÜRZUNG DER TÜREN (10, 20, 30, 40, 60, 80, 100 mm)	✓	SCHUTZ DER OBEREN TÜRROSETTE	✓
TÜREN IN ZWEIFARBIGER AUSFÜHRUNG	✓	SET TEDEE	✓
TÜRDRÜCKER/TÜRKNAUF	✓		

* FIXE ALUMINIUM-SEITENLICHTER AUF SEITE 88-89, VOLLSTÄNDIGE LISTE MIT ZUBEHÖRTEILEN AUF SEITE 94-99

SCHEIBEN



MATT



REFLEX
BRONZE



MIRA STAR
(SPIEGELGLAS)

FARBEN DER TÜREN

ALPINE NUSSBAUM



FRR

MAHAGONI



FMA

BRAZILIAN NUSSBAUM



FRB

NUSSBAUM HELL



FRP

GOLDEICHE



FDE

WINCHESTER



FDW

WEISS



FSB

STAHLGRAU



FKZ

ANTHRAZIT



FKG

ANTHRAZIT DUNKEL



FKF



W93 WERONA 3



W6A WERONA 4



WQA WERONA 5

TÜRBSCHLÄGE

TÜRDRÜCKER-
-TÜRDRÜCKER



TÜRDRÜCKER-
-TÜRKNÄUF



FARBEN DER BESCHLÄGE

ANODISIERSCHICHT
PLATINFARBEN



ANODISIERSCHICHT
SILBERN



ANODISIERSCHICHT
SCHWARZ



FARBEN DER TÜREN

ALPINE NUSSBAUM



MAHAGONI



BRAZILIAN NUSSBAUM



NUSSBAUM HELL



GOLDEICHE



WINCHESTER



WEISS



STAHLGRAU



ANTHRAZIT



ANTHRAZIT DUNKEL



CLASSIC

LIZBONA / WENECJA / LONDYN



W24 LIZBONA



W9N WENECJA

GRÖSSE	80	90N	90E
--------	----	-----	-----

MODEL	OPTIMA 50	OPTIMA 60
W24 LIZBONA	✓	✓
W9N WENECJA	✓	✓
W13 LONDYN	✓	✓
W5L LONDYN 1	-	✓

STANDARD AUSSTATTUNG RC2

• TÜRBLATT VERGLAST, ERFÜLLT DIE BEDINGUNGEN DES PROGRAMMS „REINE LUFT“	• ALUMINIUM SCHWELLE
• 3 TÜRBLATT-FALZE	• BESCHLÄGE-SET MIT SCHLIESSZYLINDER-SCHUTZ
• OPTIMA 50 STAHL-TÜRRAHMEN, OPTIMA 60 TÜRRAHMEN PERFOTHERM	• GETEILTE TÜRROSETTEN BERGEN UND BLOK
• 2D-BÄNDER MIT BLENDE IN DER FARBE DER BÄNDER	• SCHLIESSZYLINDER IN KLASSE 5 IM 1-SCHLÜSSEL-SYSTEM
• ZWEISEITIGES DESIGN	• TIEFE PRÄGUNG

AUFPREISS

ALUTHERM OPTIMA TÜRZARGE (OPTIMA 60)	✓	ELEKTROVERRIEGELUNG MIT TAG-/NACHT-FUNKTION	✓
PERFOTHERM STAHL-TÜRRAHMEN (OPTIMA 50)	✓	REED-RELAIS	✓
RC3 PAKET (OPTIMA 60 DESIGN W24, W9N, W13)	✓	SCHLIESSZYLINDER IN KLASSE 6 IM 1-SCHLÜSSEL-SYSTEM	✓
VERKÜRZUNG DER TÜREN (10, 20, 30, 40, 60, 80, 100 mm)	✓	SCHUTZ DER OBEREN TÜRROSETTE	✓
TÜREN IN ZWEIFARBIGER AUSFÜHRUNG	✓	SET TEDEE	✓
TÜRDRÜCKER/TÜRKNAUF	✓		

* FIXE ALUMINIUM-SEITENLICHTER AUF SEITE 88-89, VOLLSTÄNDIGE LISTE MIT ZUBEHÖRTEILEN AUF SEITE 94-99

SCHEIBEN



MATT



REFLEX BRONZE



MIRA STAR (SPIEGELGLAS)

FARBEN DER TÜREN

ALPINE NUSSBAUM



FRR

MAHAGONI



FMA

BRAZILIAN NUSSBAUM



FRB

NUSSBAUM HELL



FRP

GOLDEICHE



FDE

WINCHESTER



FDW

WEISS



FSB

STAHLGRAU



FKZ

ANTHRAZIT



FKG

ANTHRAZIT DUNKEL

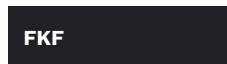

FKF



W13 LONDYN



W5L LONDYN 1

TÜRBSCHLÄGE

TÜRDRÜCKER-
-TÜRDRÜCKER



TÜRDRÜCKER-
-TÜRKNÄUF



FARBEN DER BESCHLÄGE

ANODISIERSCHICHT
PLATINFARBEN



ANODISIERSCHICHT
SILBERN



ANODISIERSCHICHT
SCHWARZ



FARBEN DER TÜREN

ALPINE NUSSBAUM



MAHAGONI



BRAZILIAN NUSSBAUM



NUSSBAUM HELL



GOLDEICHE



WINCHESTER



WEISS



STAHLGRAU



ANTHRAZIT



ANTHRAZIT DUNKEL



CLASSIC BARCELONA / GENEWA



W54 BARCELONA



W53 BARCELONA 1

GRÖSSE	80	90N	90E
--------	----	-----	-----

MODEL	OPTIMA 50	OPTIMA 60
W54 BARCELONA	✓	✓
W53 BARCELONA 1	-	✓
G76 GENEWA 1	-	✓
G75 GENEWA 2	-	✓
D75 GENEWA 3	1 599 zł	✓

STANDARD AUSSTATTUNG RC2

- TÜRLATT VERGLAST, ERFÜLLT DIE BEDINGUNGEN DES PROGRAMMS „REINE LUFT“
- 3 TÜRLATT-FALZE
- OPTIMA 50 STAHL-TÜRRAHMEN, OPTIMA 60 TÜRRAHMEN PERFOTHERM
- 2D-BÄNDER MIT BLENDE IN DER FARBE DER BÄNDER
- ZWEISEITIGES DESIGN
- ALUMINIUM SCHWELLE
- BESCHLÄGE-SET MIT SCHLIESSZYLINDER-SCHUTZ
- GETEILTE TÜRROSETTEN BERGEN UND BLOK
- SCHLIESSZYLINDER IN KLASSE 5 IM 1-SCHLÜSSEL-SYSTEM
- TIEFE PRÄGUNG (BARCELONA)

AUFPREISS

ALUTHERM OPTIMA TÜRZARGE (OPTIMA 60)	✓	ELEKTROVERRIEGELUNG MIT TAG-/NACHT-FUNKTION	✓
PERFOTHERM STAHL-TÜRRAHMEN (OPTIMA 50)	✓	REED-RELAIS	✓
RC3 PAKET (OPTIMA 60 DESIGN W54, D75)	✓	SCHLIESSZYLINDER IN KLASSE 6 IM 1-SCHLÜSSEL-SYSTEM	✓
VERKÜRZUNG DER TÜREN (10, 20, 30, 40, 60, 80, 100 mm)	✓	SCHUTZ DER OBEREN TÜRROSETTE	✓
TÜREN IN ZWEIFARBIGER AUSFÜHRUNG	✓	SET TEDEE	✓
TÜRDRÜCKER/TÜRKNAUF	✓		

* FIXE ALUMINIUM-SEITENLICHTER AUF SEITE 88-89, VOLLSTÄNDIGE LISTE MIT ZUBEHÖRTEILEN AUF SEITE 94-99

SCHEIBEN



MATT



REFLEX
BRONZE



MIRA STAR
(SPIEGELGLAS)

FARBEN DER TÜREN

ALPINE NUSSBAUM



FRR

MAHAGONI



FMA

BRAZILIAN NUSSBAUM



FRB

NUSSBAUM HELL



FRP

GOLDEICHE



FDE

WINCHESTER



FDW

WEISS



FSB

STAHLGRAU



FKZ

ANTHRAZIT



FKG

ANTHRAZIT DUNKEL



FKF



G76 GENEWA 1



G75 GENEWA 2



D75 GENEWA 3

TÜRBSCHLÄGE

TÜRDRÜCKER-
-TÜRDRÜCKER



TÜRDRÜCKER-
-TÜRKNÄUF



FARBEN DER BESCHLÄGE

ANODISIERSCHICHT
PLATINFARBEN



ANODISIERSCHICHT
SILBERN



ANODISIERSCHICHT
SCHWARZ



FARBEN DER TÜREN

ALPINE NUSSBAUM



MAHAGONI



BRAZILIAN NUSSBAUM



NUSSBAUM HELL



GOLDEICHE



WINCHESTER



WEISS



STAHLGRAU



ANTHRAZIT



ANTHRAZIT DUNKEL



TÜREN **GERDA**[®] OPTIMA 60 DUO

Die Türen OPTIMA DUO 60 sind ein Vorschlag für Personen, die nach Türen mit nicht standardmäßigen Maßen suchen. Dank der Verwendung eines sog. Standflügels kann man eine größere Durchgangsbreite erzielen. Ein Standflügel ist ohne und mit Verglasung erhältlich, damit erfüllt er gleichzeitig die Funktion eines Seitenlichtes.

MERKMALE

- ✓ EINGANGSTÜREN FÜR EIN- UND MEHRFAMILIENHÄUSER
- ✓ 60 mm STARKER STAHLFLÜGEL, GEFÜLLT MIT EXPANDIERTEM MODIFIZIERTEM POLYSTYROL
- ✓ ERHÄLTICH IM SET MIT TÜRRAHMEN PERFOTHERM UND ALUMINIUMSCHWELLE
- ✓ OPTIONAL GEGEN AUFPREIS ALUMINIUMTÜRRAHMEN ALUTHERM OPTIMA
- ✓ STANDFLÜGEL IN VOLLER UND VERGLASTER AUSFÜHRUNG, IN GRÖSSEN 30, 40, 50
- ✓ TÜREN ERHÄLTICH IN ZWÖLF FARBEN

AUSSENMASSE DER TÜRRAHMEN UND MONTAGELÖCHER, ANGEFÜHRT AUF DEN SEITEN 104-105

DESIGNS DER STANDFLÜGEL

Der Preis für den Standflügel enthält den Preis für das Zusatzteil und den Aufpreis auf die Schwelle und den Türrahmen.

BEZEICHNUNG	GRÖSSE
P00	30 40 50
PD4	40
GHI	40 50
GC2	40 50
GN5	30 40 50
GPD	30 40 50
DN3 / DN3B	30 40 50
DN6 / DN6B	30 40 50
DT8 / DT8B	30 40 50
DW9 / DW9B	30 40 50
DW8 / DW8B	30 40 50
DPE / DPEB	30 40 50
PD5	30 40 50
PD5A	30 40 50
PD5B	30 40 50
NMB	30 40 50
NMBA	30 40 50
NMBB	30 40 50
NMA	30 40 50
NMAA	30 40 50
NMAB	30 40 50

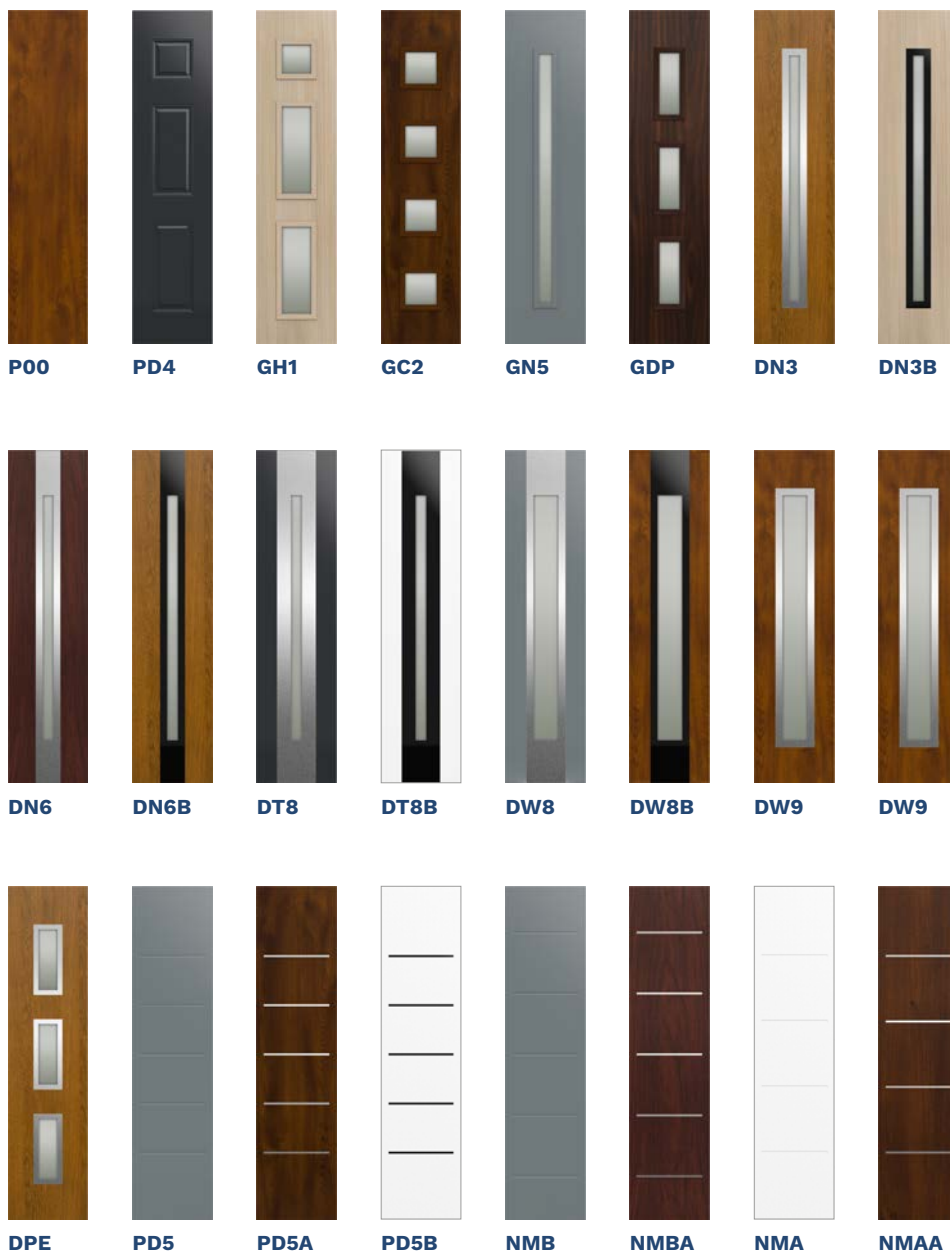



SOJ BERGAMO2 + NMBA



NS5 HANOVER 5 + DW9



ST8 RYGA + P00



TMMA TOKIO 2A + P00



NS9 MILANO 12 + DW8



SNUA MILANO 4A + PD5A



NT2B TURYN 2B + DT8



ST4A UPPSALA 1A + NMAA



NS6 HANOVER 6 + DW8

ALUMINIUM-SEITENLICHTER GERDA®



GL SET



G SET



GP SET



L SET

ALUMINIUM-SEITENLICHTER THERMO PRIME 75 TÜREN

TÜRRAHMEN ALUTHERM PRIME

Maße	Höhe Hz	Breite B
80	Standard 2087 mm Nicht-Standard:	918 mm
90N	2150 mm 2200 mm	988 mm
90E	2250 mm 2300 mm	1031 mm
100E	2350 mm 2400 mm	1131 mm

SEITENLICHTER

GESAMTHÖHE	ART DES SEITENLICHTES/ SCHEIBEN	BREITE	
		300 - 550 mm	600 - 900 mm
2087 mm	SEITENLICHTER MIT SCHEIBE AUS SICHERHEITSGLAS	✓	✓
	SEITENLICHTER EINBRUCHHEMMEND RC2 MIT SCHEIBE P4	✓	✓
2400 mm	SEITENLICHTER MIT SCHEIBE AUS SICHERHEITSGLAS	✓	✓
	SEITENLICHTER EINBRUCHHEMMEND RC2 MIT SCHEIBE P4	✓	✓

* SEITENLICHTER STANDARD BREITE IN 50 mm INCREMENTS. FOR 10 mm INCREMENTS – 25% AUFPREIS

TOP ILLUMINATORS

ILLUMINATOR HEIGHT	ART DES SEITENLICHTES/ SCHEIBEN	BREITE				
		918 - 1150 mm	bis zu 1550 mm	bis zu 1950 mm	bis zu 2350 mm	bis zu 2950 mm
300 - 500 mm	SEITENLICHTER MIT SCHEIBE AUS SICHERHEITSGLAS	✓	✓	✓	✓	✓
300 - 500 mm	SEITENLICHTER EINBRUCHHEMMEND RC2 MIT SCHEIBE P4	✓	✓	✓	✓	✓

SEITENLICHTER STANDARDBREITE IM INTERVALL VON 50 mm. IM INTERVALL VON 10 mm AUFPREIS 25%



P SET



LP SET



LGP SET

ALUMINIUM-SEITENLICHTER
FÜR THERMO PREMIUM 75,
THERMO PREMIUM 60
UND OPTIMA 60 TÜREN

TÜRRAHMEN ALUTHERM PREMIUM, OPTIMA

Maße	Höhe Hz	Breite B
80N	2087 mm	888 mm
80		918 mm
90N		988 mm
90E		1031 mm
100E		1131 mm

SEITENLICHTER

GESAMTHÖHE	ART DES SEITENLICHTES/ SCHEIBEN	BREITE	
		250-550 mm	600-900 mm
2087 mm	SEITENLICHTER MIT SCHEIBE AUS SICHERHEITSGLAS	✓	✓
	SEITENLICHTER EINBRUCHHEMMEND RC2 MIT SCHEIBE P4	✓	✓

* SEITENLICHTER STANDARD BREITE IN 50 mm INCREMENTS. FOR 10 mm INCREMENTS – 25% AUFPREIS

TOP ILLUMINATORS

ILLUMINATOR HEIGHT	ART DES SEITENLICHTES/ SCHEIBEN	BREITE				
		888 - 1150 mm	bis zu 1550 mm	bis zu 1950 mm	bis zu 2350 mm	bis zu 2950 mm
250 -500 mm	SEITENLICHTER MIT SCHEIBE AUS SICHERHEITSGLAS	✓	✓	✓	✓	✓
250 -500 mm	SEITENLICHTER EINBRUCHHEMMEND RC2 MIT SCHEIBE P4	✓	✓	✓	✓	✓

SEITENLICHTER STANDARDBREITE IM INTERVALL VON 50 mm. IM INTERVALL VON 10 mm AUFPREIS 25%.

REICHHALTIGE FARBPALETTE

GERDA®

WÄHLEN SIE DIE FARBE IHRER TÜR AUS

ALPINE NUSSBAUM



FRR

MAHAGONI



FMA

BRAZILIAN NUSSBAUM



FRB

LIGHT WENGE



FEJ

WEISS

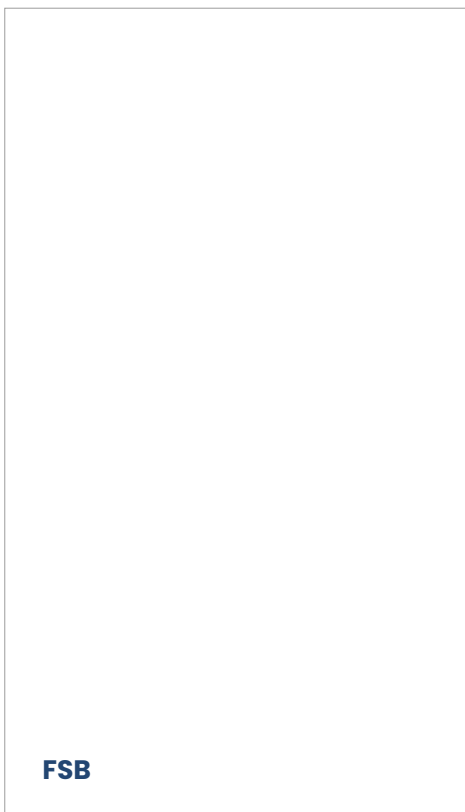

FSB

STAHLGRAU



FKZ

WÄHLEN SIE DIE FARBE IHRER TÜR AUS

NUSSBAUM HELL



GOLDEICHE



WINCHESTER



ANTHRAZIT

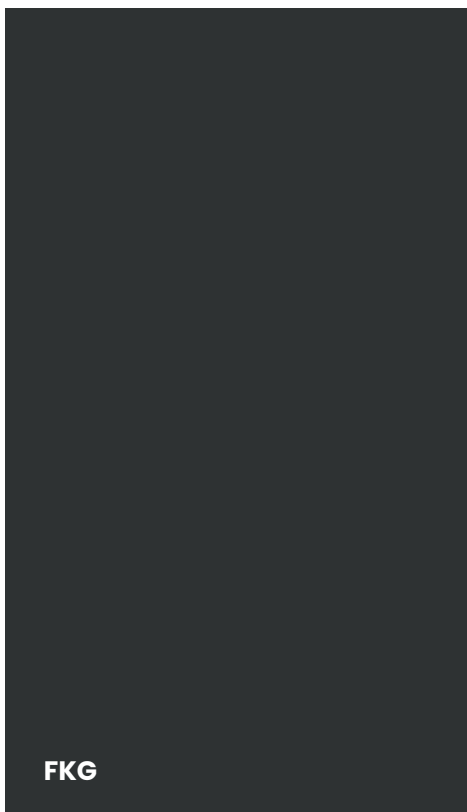

ANTHRAZIT DUNKEL

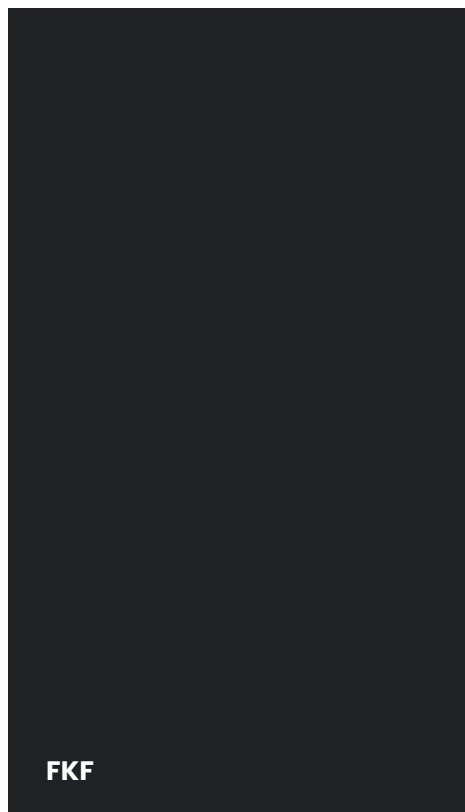

SCHWARZ



THERMO PRIME / THERMO PREMIUM (BEISPIELSWEISE KONFIGURATIONEN)

**TW300 BERGEN
(TÜRDRÜCKER ALEX)
THERMO PRIME**

**RINGFÖRMIGE TÜRROSETTE
(EINSEITIGER TÜRDRÜCKER
ALEX), GRIFF**

**TD200 BERGEN
(TÜRDRÜCKER BETA)**

**TD200 BERGEN
(TÜRKNAUF-TÜRDRÜCKER
ALEX)**

AMSTERDAM MONTREAL



FARBEN DER TÜRROSETTEN

ANODISIERSCHICHT PLATINFARBEN

ANODISIERSCHICHT SILBERN

ANODISIERSCHICHT SCHWARZ



STANDARD-ZUBEHÖRSET THERMO PRIME / PREMIUM ✓

SCHLIESSZYLINDER KLASSE 5 THERMO PRIME / SCHLIESSZYLINDER KLASSE 5 IM 1-SCHLÜSSEL-SYSTEM THERMO PREMIUM

5 SCHLÜSSEL + MONTAGE-SET

TÜRROSETTE FÜR HAUPTSCHLOSS MIT SCHUTZVORRICHTUNG

TÜRROSETTE FÜR ZUSATZSCHLOSS OHNE SCHUTZVORRICHTUNG THERMO PREMIUM

BLENDEN AUF BÄNDERN IN DER FARBE DER TÜRROSETTEN

AUFPREISS

TÜRROSETTE FÜR ZUSATZSCHLOSS MIT SCHUTZVORRICHTUNG ✓

SET TÜRKNAUF - TÜRDRÜCKER ✓

SCHLIESSZYLINDER IN KLASSE 6 THERMO PRIME ✓

SCHLIESSZYLINDER IN KLASSE 6 IM 1-SCHLÜSSEL-SYSTEM THERMO PREMIUM ✓

SCHLIESSZYLINDER DES HAUPTSCHLOSSES IN KLASSE 5 / ZUSATZSCHLOSSES IN KLASSE 2 THERMO PREMIUM ✓

GRIFF AMSTERDAM / MONTREAL 1500 mm, EMPFOHLENE ELEKTROVERRIEGELUNG ✓

GRIFF AMSTERDAM / MONTREAL 1000 mm, EMPFOHLENE ELEKTROVERRIEGELUNG ✓

GRIFF MIT DRÜCKER AMSTERDAM / MONTREAL 1500 MM MIT TÜRBLATTANPASSUNG, ERFORDERLICHE ELEKTROVERRIEGELUNG ✓

GRIFF MIT DRÜCKER AMSTERDAM / MONTREAL 1000 mm MIT TÜRBLATTANPASSUNG, ERFORDERLICHE ELEKTROVERRIEGELUNG ✓

TEDEE-SET ✓

OPTIMA (BEISPIELSWEISE KONFIGURATIONEN)

TW200 BLOK (TÜRDRÜCKER BETA)

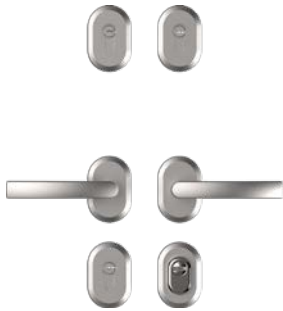

TW200 BLOK (TÜRKNAUF-TÜRDRÜCKER BETA)

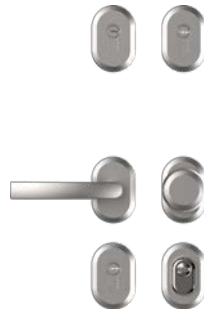

TW300 BERGEN (TÜRKNAUF-TÜRDRÜCKER ALEX)



TW200 BLOK (TÜRDRÜCKER EINSEITIG BETA), GRIFF

AMSTERDAM MONTREAL

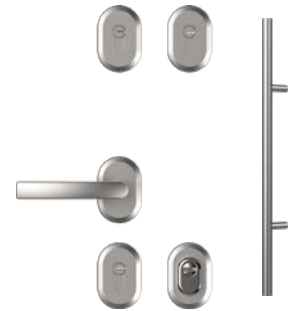

FARBEN DER TÜRROSETTEN

ANODISIERSCHICHT PLATINFARBEN



ANODISIERSCHICHT SILBERN



ANODISIERSCHICHT SCHWARZ



STANDARD-ZUBEHÖRSET OPTIMA



SCHLIESSZYLINDER KLASSE 5 IM 1-SCHLÜSSEL-SYSTEM

5 SCHLÜSSEL + MONTAGE-SET

TÜRROSETTE FÜR HAUPTSCHLOSS MIT SCHUTZVORRICHTUNG

TÜRROSETTE FÜR ZUSATZSCHLOSS OHNE SCHUTZVORRICHTUNG

BLENDEN AUF BÄNDERN IN DER FARBE DER TÜRROSETTEN

AUFPREISS

TÜRROSETTE FÜR ZUSATZSCHLOSS MIT SCHUTZVORRICHTUNG



SET TÜRKNAUF - TÜRDRÜCKER



SCHLIESSZYLINDER IN KLASSE 6 THERMO PRIME



SCHLIESSZYLINDER IN KLASSE 6 IM 1-SCHLÜSSEL-SYSTEM THERMO PREMIUM



SCHLIESSZYLINDER DES HAUPTSCHLOSSES IN KLASSE 5 / ZUSATZSCHLOSSES IN KLASSE 2 THERMO PREMIUM -



GRIFF AMSTERDAM / MONTREAL 1500 mm, EMPFOHLENE ELEKTROVERRIEGELUNG



GRIFF AMSTERDAM / MONTREAL 1000 mm, EMPFOHLENE ELEKTROVERRIEGELUNG



GRIFF MIT DRÜCKER AMSTERDAM / MONTREAL 1500 mm MIT TÜRBLATTANPASSUNG, ERFORDERLICHE ELEKTROVERRIEGELUNG



GRIFF MIT DRÜCKER AMSTERDAM / MONTREAL 1000 mm MIT TÜRBLATTANPASSUNG, ERFORDERLICHE ELEKTROVERRIEGELUNG



TEDEE-SET



OPTIONALE AUSSTATTUNG











GERDA®

AUFPREISE AUF TÜREN

	OPTIMA 50	OPTIMA 60	THERMO PREMIUM 60	THERMO PREMIUM 75	THERMO PRIME 75
ELEKTROVERRIEGELUNG MIT TAG-/NACHT-FUNKTION; WERKSEITIG INSTALLIERT IM TÜRRAHMEN (AUFPREIS AUF DEN PREIS FÜR DIE TÜR); EMPFOHLEN FÜR TÜREN MIT GRIFF; EMPFOHLENER EINSATZ EINES mm MIT NETZTEILS – ZUSÄTZLICHES ZUBEHÖR S. 97	✓	✓	✓	✓	✓
ELEKTROVERRIEGELUNG MIT TAG-/NACHT-FUNKTION, INSTALLIERT IM ZUSATZTEIL DUO, EMPFOHLEN FÜR TÜREN MIT GRIFFEN	-	✓	-	-	-
REED-RELAIS, WERKSEITIG INSTALLIERT IM TÜRRAHMEN	✓	✓	✓	✓	✓
VERKÜRZUNG DER TÜR IM BEREICH 0 – 100 (FÜR AUSGEWÄHLTE DESEIGNS)	✓	✓	✓	✓	✓
HÖHERE TÜR GESAMTHÖHE BIS ZU 2400	-	-	-	-	2150 mm; 2200 mm; 2250 mm; 2300 mm; 2350 mm; 2400 mm
TÜRBLATT ZWEIFARBIGE TÜREN	✓	✓	✓	✓	✓
INNENVERSTÄRKUNG DES TÜRBLATTES FÜR ANGEBAUTEN TÜRSCHLIESSER (AUFPREIS AUF TÜREN)	✓	✓	✓	✓	✓
VERDECKT INSTALLIERTER TÜRSCHLIESSER	-	-	✓	✓	✓
WETTERSCHENKEL (EMPFOHLEN FÜR NACH INNEN ÖFFNENDE TÜREN)	✓	✓	✓	✓	✓
ANPASSUNG AN DEN GRIFF MIT DRÜCKER	✓	✓	✓	✓	✓

TÜRDRÜCKER UND TÜRROSETTEN







OPTIMA 50 OPTIMA 60 THERMO PREMIUM 60 THERMO PREMIUM 75 THERMO PRIME 75

	BERGEN – TÜRDRÜCKER AUF LANGER TÜRROSETTE TD200 BEIDSEITIG	-	-	✓	✓	-
	BERGEN – TÜRDRÜCKER AUF LANGER TÜRROSETTE TD1000 BEIDSEITIG	-	-	✓	✓	-
	BERGEN – TÜRDRÜCKER AUF LANGER TÜRROSETTE EINSEITIG	-	-	✓	✓	-
	BERGEN – TÜRDRÜCKER/TÜRKNAUF AUF LANGER TÜRROSETTE TD200	-	-	✓	✓	-
	BERGEN – TÜRDRÜCKER/TÜRKNAUF AUF LANGER TÜRROSETTE TD1000	-	-	✓	✓	-
	BERGEN – TÜRDRÜCKER AUF GETEILTER TÜRROSETTE BEIDSEITIG	✓	✓	-	-	✓
	BERGEN – TÜRDRÜCKER AUF GETEILTER TÜRROSETTE EINSEITIG	✓	✓	-	-	✓
	BERGEN – TÜRDRÜCKER/TÜRKNAUF AUF GETEILTER TÜRROSETTE	✓	✓	-	-	✓
	BERGEN – GETEILTE TÜRROSETTE MIT SCHLIESSZYLINDERSCHUTZ TW300	✓	✓	✓	✓	✓
	BERGEN – GETEILTE TÜRROSETTE OHNE SCHLIESSZYLINDERSCHUTZ	✓	✓	✓	✓	✓

OPTIONALE AUSSTATTUNG

GERDA®

TÜRDRÜCKER UND TÜRROSETTEN

	OPTIMA 50	OPTIMA 60	THERMO PREMIUM 60	THERMO PREMIUM 75	THERMO PRIME 75
 BLOCK – TÜRDRÜCKER AUF GETEILTER TÜRROSETTE BEIDSEITIG	✓	✓	-	-	-
 BLOCK – TÜRDRÜCKER AUF GETEILTER TÜRROSETTE EINSEITIG	✓	✓	-	-	-
 BLOCK – TÜRDRÜCKER/TÜRKNAUF AUF GETEILTER TÜRROSETTE	✓	✓	-	-	-
 BLOCK – GETEILTE TÜRROSETTE MIT SCHLIESSZYLINDERSCHUTZ TW200	✓	✓	-	-	-
 BLOCK – GETEILTE TÜRROSETTE MIT SCHLIESSZYLINDERSCHUTZ TW1000	✓	✓	-	-	-
 BLOCK – GETEILTE TÜRROSETTE OHNE SCHLIESSZYLINDERSCHUTZ	✓	✓	-	-	-

GRIFFE

	OPTIMA 50	OPTIMA 60	THERMO PREMIUM 60	THERMO PREMIUM 75	THERMO PRIME 75
 AMSTERDAM RECHTECKIGER GRIFF 1500 (QUERSCHNITT 40 × 20 mm)	✓	✓	✓	✓	✓
 AMSTERDAM RECHTECKIGER GRIFF 1500 (QUERSCHNITT 40 × 20 mm)	✓	✓	✓	✓	✓
 AMSTERDAM RECHTECKIGER GRIFF MIT DRÜCKER 1500 (QUERSCHNITT 40 × 20 mm), ERFORDERLICHER KAUF EINER ELEKTROVERRIEGELUNG	✓	✓	✓	✓	✓
 AMSTERDAM RECHTECKIGER GRIFF MIT DRÜCKER 1000 (QUERSCHNITT 40 × 20 mm), ERFORDERLICHER KAUF EINER ELEKTROVERRIEGELUNG	✓	✓	✓	✓	✓
 MONTREAL RUNDER GRIFF 1500	✓	✓	✓	✓	✓
 MONTREAL RUNDER GRIFF 1000	✓	✓	✓	✓	✓
 MONTREAL RUNDER GRIFF MIT DRÜCKER 1500, ERFORDERLICHER KAUF EINER ELEKTROVERRIEGELUNG	✓	✓	✓	✓	✓
 MONTREAL RUNDER GRIFF MIT DRÜCKER 1000, ERFORDERLICHER KAUF EINER ELEKTROVERRIEGELUNG	✓	✓	✓	✓	✓

ZUBEHÖR

		OPTIMA 50	OPTIMA 60	THERMO PREMIUM 60	THERMO PREMIUM 75	THERMO PRIME 75
	BREITWINKEL-TÜRSPION 50/80	✓	✓	✓	✓	✓
	ELEKTRONISCHER TÜRSPION 4,3"	✓	✓	✓	✓	✓
	ELEKTRONISCHER TÜRSPION 2,4"	✓	✓	✓	✓	✓
	NUMERISCHE TASTATUR DER ZUGRIFFSKONTROLLE	✓	✓	✓	✓	✓
	PUFFER-NETZTEIL AWZG2-12V; EMPFOHLEN FÜR TÜREN MIT ELEKTROVERRIEGELUNG	✓	✓	✓	✓	✓
	IMPULS-NETZTEIL PSC12015; EMPFOHLEN FÜR TÜREN MIT ELEKTROVERRIEGELUNG	✓	✓	✓	✓	✓
	UNTERE SCHLISSLEISTE	✓	✓	-	-	-
	VERDECKT INSTALLIERTER TÜRSCHLIESSER	-	-	✓	✓	✓
	TÜRSCHLIESSER GT 1500 STANDARD	✓	✓	✓	✓	✓
	TÜRSCHLIESSER GT 1500 BLOCKADE	✓	✓	✓	✓	✓
	DEKORATIVE ALUMINIUMBLENDEN AUF BÄNDER	✓	✓	✓	✓	✓
	ALUMINIUMSCHWELLE 20 mm	✓	✓	-	-	-
	WÄRMEISOLIERTE ALUMINIUMSCHWELLE 20 mm	-	-	✓	✓	✓
	WÄRMEISOLIERTE SCHWELLE PCV 20 mm	-	-	✓	✓	-
	HOLZSCHWELLE 19 mm	✓	✓	-	-	-
	WETTERSCHENKEL IN DER FARBE DES TÜRBLATTES	✓	✓	✓	✓	✓

OPTIONALE AUSSTATTUNG

GERDA®

ZUBEHÖR

		OPTIMA 50	OPTIMA 60	THERMO PREMIUM 60	THERMO PREMIUM 75	THERMO PRIME 75
	SEITLICHE STAHL-HOLZ-VERBREITERUNG 30 mm (FÜR TÜRRAHMEN PERFOTHERM, DUOTHERM)	✓	✓	✓	✓	-
	SEITLICHE STAHL-HOLZ-VERBREITERUNG 60 mm (FÜR TÜRRAHMEN PERFOTHERM, DUOTHERM)	✓	✓	✓	✓	-
	SEITLICHE ALUMINIUM-VERBREITERUNG 28 mm (FÜR TÜRRAHMEN ALUTHERM UND ALUMINIUM-SEITENLICHTER)	-	✓	✓	✓	-
	SEITLICHE ALUMINIUM-VERBREITERUNG 52 mm (FÜR TÜRRAHMEN ALUTHERM UND ALUMINIUM-SEITENLICHTER)	-	✓	✓	✓	-
	SEITLICHE ALUMINIUM-VERBREITERUNG 114 mm (FÜR TÜRRAHMEN ALUTHERM UND ALUMINIUM-SEITENLICHTER)	-	✓	✓	✓	-
	SEITLICHE ALUMINIUM-VERBREITERUNG 25 mm (FÜR TÜRRAHMEN ALUTHERM PRIME)	-	-	-	-	✓
	SEITLICHE ALUMINIUM-VERBREITERUNG 33 mm (FÜR TÜRRAHMEN ALUTHERM PRIME)	-	-	-	-	✓
	SEITLICHE ALUMINIUM-VERBREITERUNG 44 mm (FÜR TÜRRAHMEN ALUTHERM PRIME)	-	-	-	-	✓
	SEITLICHE ALUMINIUM-VERBREITERUNG 55 mm (FÜR TÜRRAHMEN ALUTHERM PRIME)	-	-	-	-	✓
	SEITLICHE ALUMINIUM-VERBREITERUNG 108 mm (FÜR TÜRRAHMEN ALUTHERM PRIME)	-	-	-	-	✓
	UNTERSCHWELLEN-VERBREITERUNG 30 mm (MB)	✓	✓	✓	✓	-
	GRUNDSCHWELLEN (UNTERSCHWELLEN- VERBREITERUNGEN) AUS GEHÄRTETEM EXPANDIERTEM POLYSTYROL. (THERMO PRIME)	-	-	-	-	
						70 mm, 100 mm, 130 mm, 160 mm, 190 mm, 220 mm, 250 mm
	TÜRPFLEGEMITTEL	✓	✓	✓	✓	✓
	PFLEGEMITTEL FÜR SCHLÖSSER UND SCHLIESSZYLINDER 25 ml	✓	✓	✓	✓	✓
	PFLEGEMITTEL FÜR SCHLÖSSER UND SCHLIESSZYLINDER 100 ml	✓	✓	✓	✓	✓
	PFLEGEMITTEL FÜR SCHLÖSSER UND SCHLIESSZYLINDER 400 ml	✓	✓	✓	✓	✓
	SET VON PRÄPARATEN ZUR REINIGUNG VON EDELSTAHL GERDA INOX-1, INOX-2	✓	✓	✓	✓	✓
	GERDA-BÄNDER RESIST ULTRA DUO FÜR WÄRMEISOLIERUNGSMONTAGE	✓	✓	✓	✓	✓

OPTIMA 50 RC2

MASSE	HAUPTSCHLOSS	ZUSATZSCHLOSS	ANZAHL DER SCHLÜSSEL	KLASSE SCHLIESSZYLINDER
30/45	MITNEHMER	-	5	2
30/45 ; 45/30	-	MITNEHMER	5	2
30/45 ; 45/30	MITNEHMER	MITNEHMER	5+MONTAGE-SET	5
30/45 ; 45/30	MITNEHMER	MITNEHMER	5+MONTAGE-SET	6

OPTIMA 60 RC2

MASSE	HAUPTSCHLOSS	ZUSATZSCHLOSS	ANZAHL DER SCHLÜSSEL	KLASSE SCHLIESSZYLINDER
35/50	MITNEHMER	-	5	2
35/50 ; 50/35	-	MITNEHMER	5	2
35/50 ; 50/35	MITNEHMER	MITNEHMER	5+MONTAGE-SET	5
35/50 ; 50/35	MITNEHMER	MITNEHMER	5+MONTAGE-SET	6

OPTIMA 60 RC3

MASSE	HAUPTSCHLOSS	ZUSATZSCHLOSS	ANZAHL DER SCHLÜSSEL	KLASSE SCHLIESSZYLINDER
35/50 ; 50/35	KETTENSTANGE	MITNEHMER	5+MONTAGE-SET	5
35/50 ; 50/35	KETTENSTANGE	MITNEHMER	5+MONTAGE-SET	6

THERMO PREMIUM 60 RC2

MASSE	HAUPTSCHLOSS	ZUSATZSCHLOSS	ANZAHL DER SCHLÜSSEL	KLASSE SCHLIESSZYLINDER
35/50	MITNEHMER	-	5+MONTAGE-SET	5
35/50 ; 50/35	-	MITNEHMER	5	2
35/50 ; 50/35	MITNEHMER	MITNEHMER	5+MONTAGE-SET	5
35/50 ; 50/35	MITNEHMER	MITNEHMER	5+MONTAGE-SET	6

THERMO PREMIUM 60 RC3

MASSE	HAUPTSCHLOSS	ZUSATZSCHLOSS	ANZAHL DER SCHLÜSSEL	KLASSE SCHLIESSZYLINDER
35/50	KETTENSTANGE	-	5+MONTAGE-SET	5
35/50 ; 50/35	-	MITNEHMER	5	2
35/50 ; 50/35	KETTENSTANGE	MITNEHMER	5+MONTAGE-SET	5
35/50 ; 50/35	KETTENSTANGE	MITNEHMER	5+MONTAGE-SET	6

THERMO PREMIUM 75 RC2/RC3

MASSE	HAUPTSCHLOSS	ZUSATZSCHLOSS	ANZAHL DER SCHLÜSSEL	KLASSE SCHLIESSZYLINDER
45/55	KETTENSTANGE	-	5+MONTAGE-SET	5
45/55 ; 55/45	-	MITNEHMER	5	2
45/55 ; 55/45	KETTENSTANGE	MITNEHMER	5+MONTAGE-SET	5
45/55 ; 55/45	KETTENSTANGE	MITNEHMER	5+MONTAGE-SET	6

THERMO PRIME 75 RC2/RC3

MASSE	HAUPTSCHLOSS	ZUSATZSCHLOSS	ANZAHL DER SCHLÜSSEL	KLASSE SCHLIESSZYLINDER
55/45	MITNEHMER	TÜRDRÜCKER / TÜRDRÜCKER NACH INNEN	5+MONTAGE-SET	5
55/35	MITNEHMER	TÜRDRÜCKER / GRIFF NACH INNEN	5+MONTAGE-SET	5
45/50	MITNEHMER	TÜRDRÜCKER / TÜRDRÜCKER AUSSEN	5+MONTAGE-SET	5
G50/50	MITNEHMER	TÜRDRÜCKER / TÜRDRÜCKER AUSSEN	5+MONTAGE-SET	5
45/35	MITNEHMER	TÜRDRÜCKER / GRIFF AUSSEN	5+MONTAGE-SET	5
G50/35	MITNEHMER	TÜRDRÜCKER / GRIFF AUSSEN	5+MONTAGE-SET	5

ZWEI-SCHLOSS-TÜREN: HAUPTSCHLOSS - SCHLIESSZYLINDER SCHLÜSSEL/SCHLÜSSEL; ZUSATZSCHLOSS - SCHLIESSZYLINDER SCHLÜSSEL/TÜRKNAUF.
 EIN-SCHLOSS-TÜREN: HAUPTSCHLOSS - SCHLIESSZYLINDER SCHLÜSSEL/SCHLÜSSEL ODER SCHLÜSSEL/TÜRKNAUF.

MASSE DER TÜREN UND TÜRRAHMEN

GERDA®

ABMESSUNGEN TÜRBLATT THERMO PRIME / THERMO PREMIUM (mm)

BREITE

GRÖSSE	TÜRENMODELL	TÜRBLATTBREITE SCHMALERE SEITE (Sp)	TÜRBLATTBREITE BREITERE SEITE (Ss)
80	THERMO PRIME / THERMO PREMIUM	812	842
90N		882	912
90E		925	955
100E		1025	1055

HÖHE

TÜRENMODELL	HÖHE	TÜRBLATTHÖHE SCHMALERE SEITE (Hs)	TÜRBLATTHÖHE BREITERE SEITE (Hp)
T. PRIME / T.PREMIUM	2087	2009	2039
THERMO PRIME	2100	2022	2052
	2150	2072	2102
	2200	2122	2152
	2250	2172	2202
	2300	2222	2252
	2350	2272	2302
	2400	2322	2352

MASSE TÜRRAHMEN ALUTHERM PRIME / ALUTHERM PREMIUM / DUOTHERM (mm)

GRÖSSE	TÜRRAHMEN-MODELL	GESAMTBREITE TÜRRAHMEN (Sc)	EMPFOHLENE BREITE DER MONTAGEÖFFNUNG (Sm)*	GESAMTHÖHE TÜRRAHMEN (Hc)	EMPFOHLENE HÖHE DER MONTAGEÖFFNUNG VOM NIVEAU "0" (Hm)
80	DUOTHERM	896	916	2076	2086
90 N		966	986		
90 E		1009	1029		
100 E		1109	1129		
80	ALUTHERM	918	938	STANDARD 2087 NICHT-STANDARD**	STANDARD 2097 NICHT-STANDARD**
90 N		988	1008		
90 E		1031	1051		
100 E		1131	1151		

* ENTHÄLT MONTAGEABSTAND 10 mm

** NUR THERMO PRIME

THERMO PRIME 75 / THERMO PREMIUM 75

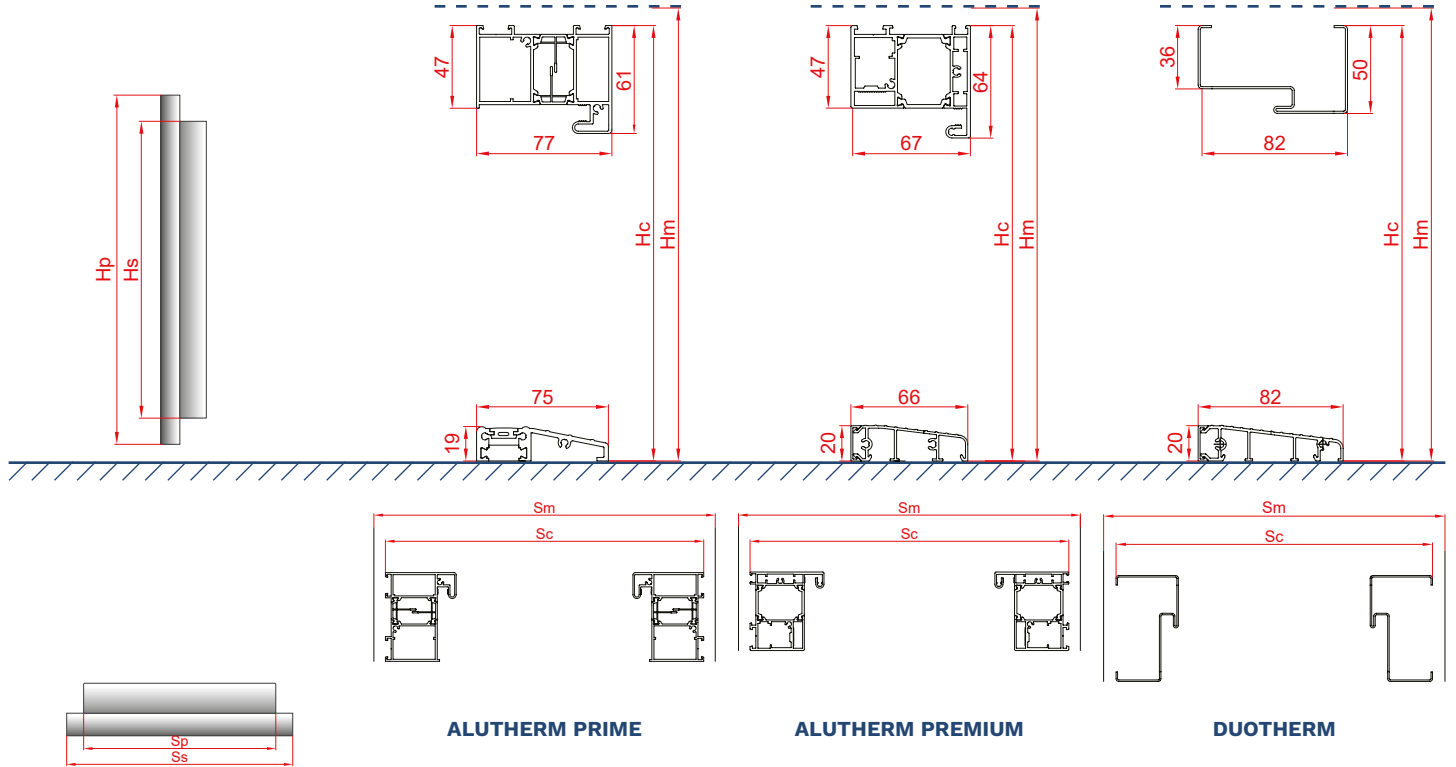

THERMO PREMIUM 60

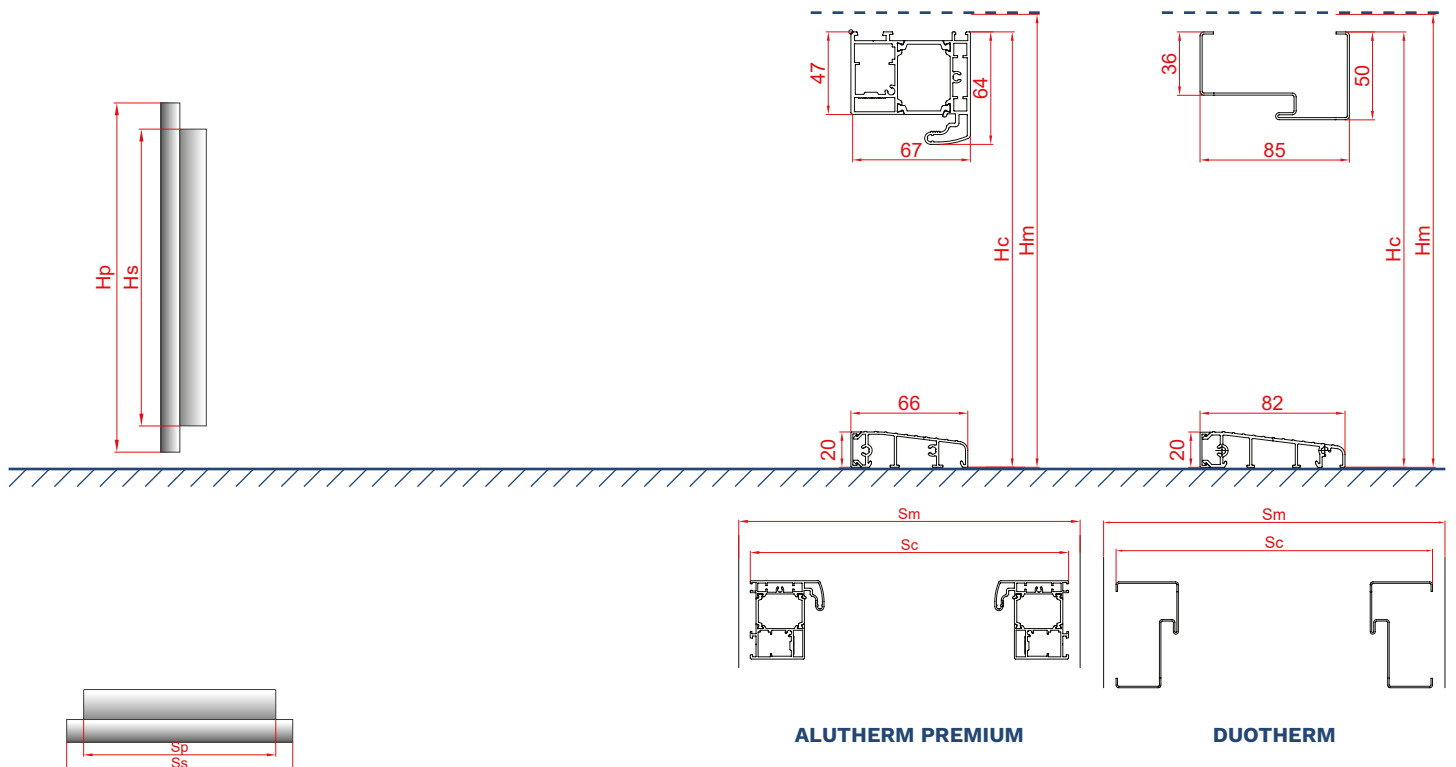

* TÜREN IN DUNKLEN FARBEN SIND NICHT AN ORTEN MIT LANGER UND DIREKTER SONNENEINSTRALUNG EINZUBAUEN. TÜREN; EINGEBAUT ALS AUSSEN-EINGANGSTÜREN AN ORTEN MIT DIREKTER EINWIRKUNG VON WITTERUNGSFAKTOREN (REGEN, WIND, ETC.) SOLLTEN NACH AUSSEN ÖFFNENDE TÜREN SEIN. IM FALLE VON TÜREN; DIE ALS SMA AUSSEN-EINGANGSTÜREN EINGEBAUT WERDEN, IST DER EINSATZ EINER ÜBERDACHUNG ERFORDERLICH.

MASSE DER TÜREN UND TÜRRAHMEN

GERDA®

ABMESSUNGEN TÜRBLATT OPTIMA (mm)

GRÖSSE	TÜRENMODELL	TÜRBLATTBREITE SCHMALERE SEITE (Sp)	TÜRBLATTBREITE BREITERE SEITE (Ss)	TÜRBLATTHÖHE SCHMALERE SEITE (Hs)	TÜRBLATTHÖHE BREITERE SEITE (Hp)
80N	OPTIMA	782	812	2023	2038,5
80		812	842		
90N		882	912		
90E		925	955		
100E		1025	1055		
30	OPTIMA DUO 60	257	287		
40		357	387		
50		457	487		

MASSE TÜRRAHMEN ALUTHERM OPTIMA, PERFOTHERM, FB (mm)

GRÖSSE	TÜRRAHMEN-MODELL	GESAMTBREITE TÜRRAHMEN (Sc)	EMPFOHLENE BREITE DER MONTAGEÖFFNUNG (Sm)*	GESAMTHÖHE TÜRRAHMEN (Hc)	EMPFOHLENE HÖHE DER MONTAGEÖFFNUNG VOM NIVEAU "0" (Hm)
80N	PERFOTHERM, FB	866	886	2076	2086
80		896	916		
90 N		966	986		
90 E		1009	1029		
100 E		1109	1129		
80	ALUTHERM	918	938	2087	2097
90 N		988	1008		
90 E		1031	1051		
100 E		1131	1151		

* ENTHÄLT MONTAGEABSTAND 10 mm

OPTIMA 60

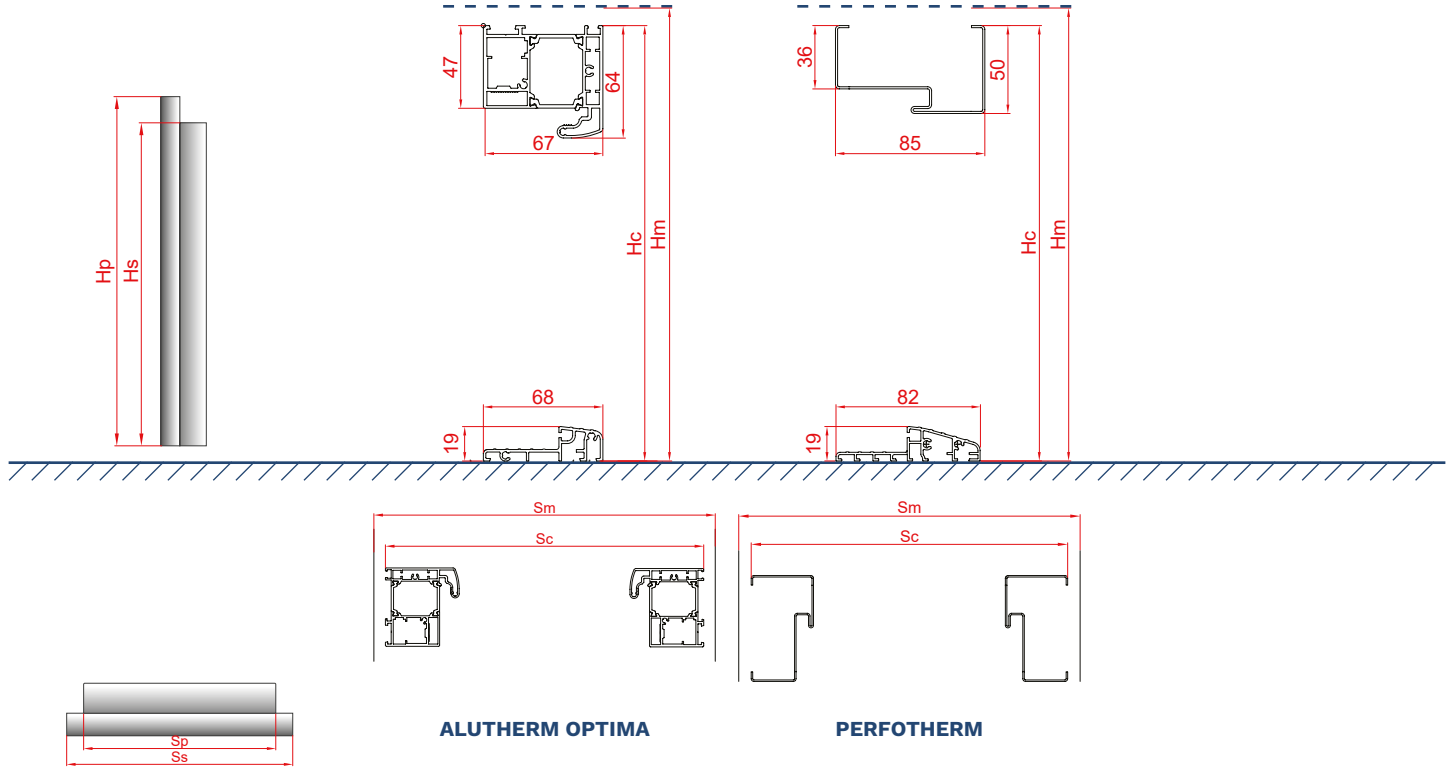

OPTIMA 50

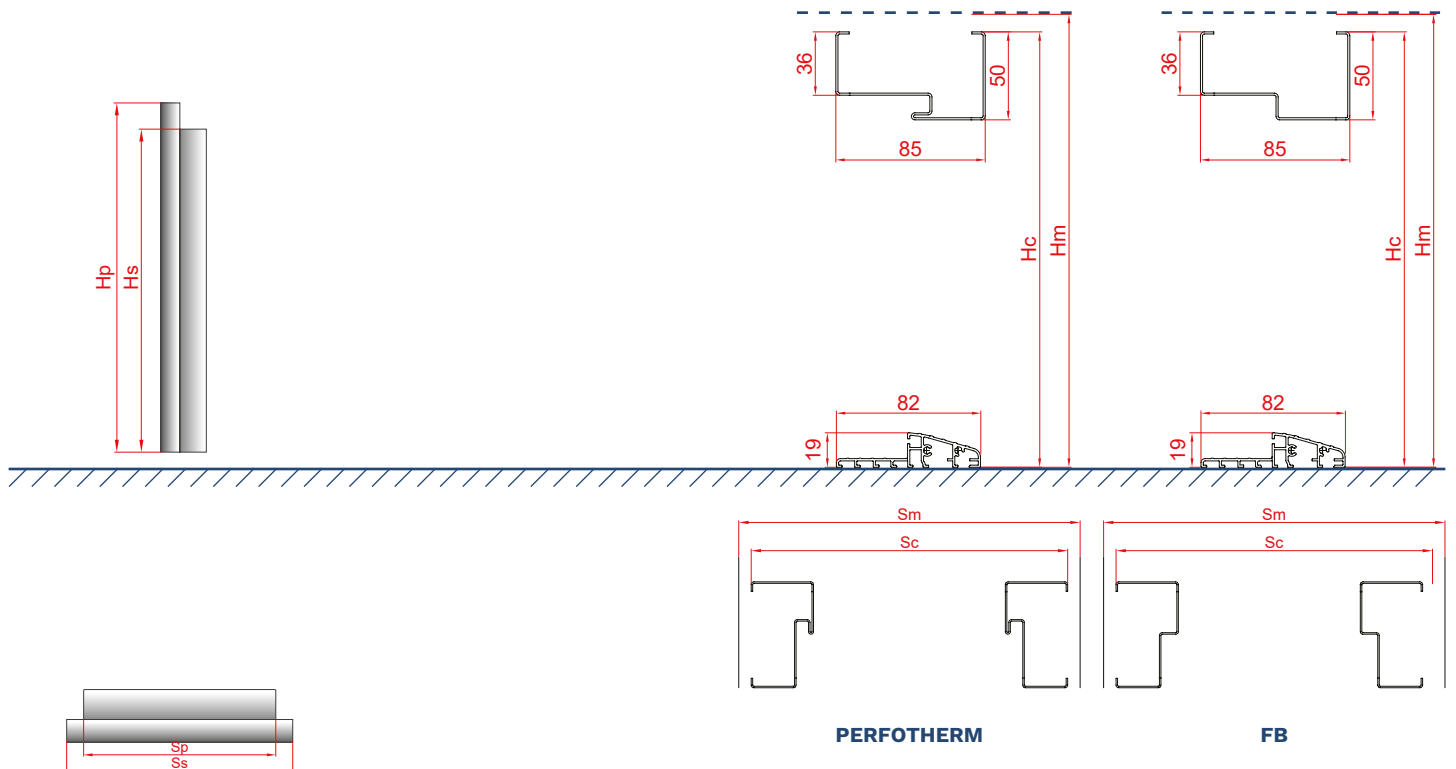

* TÜREN IN DUNKLEN FARBEN SIND NICHT AN ORTEN MIT LANGER UND DIREKTER SONNENEINSTRALUNG EINZUBAUEN. TÜREN; EINGEBAUT ALS AUSSEN-EINGANGSTÜREN AN ORTEN MIT DIREKTER EINWIRKUNG VON WITTERUNGSFAKTOREN (REGEN, WIND, ETC.) SOLLTEN NACH AUSSEN ÖFFNENDE TÜREN SEIN. IM FALLE VON TÜREN; DIE ALS SMA AUSSEN-EINGANGSTÜREN EINGEBAUT WERDEN, IST DER EINSATZ EINER ÜBERDACHUNG ERFORDERLICH.

MASSE DER TÜREN UND TÜRRAHMEN

GERDA®

MASSE TÜRRAHMEN FN FÜR TÜREN OPTIMA (mm)

GRÖSSE	TÜRRAHMEN- -MODELL	GESAMTBREITE TÜRRAHMEN (Sc1)	GESAMTBREITE TÜRRAHMEN (Sc2)	EMPFOHLENE BREITE DER MON- TAGEÖFFNUNG (Sm)	GESAMTHÖHE TÜRRAHMEN (Hc1)	GESAMTHÖHE TÜRRAHMEN (Hc2)	EMPFOHLENE HÖHE DER MONTAGEÖFFNUNG VOM NIVEAU "0" (Hm)
80N	FN	862	797	817	2075	2041	2051
80		892	827	847			
90N		962	897	917			
90E		1005	940	960			
100E		1105	1040	1060			

MASSE TÜRRAHMEN ALUTHERM OPTIMA, PERFOTHERM FÜR TÜREN OPTIMA DUO 60 (mm)

GRÖSSE	ALUTHERM		PERFOTHERM		ALUTHERM		PERFOTHERM	
	GESAMTBREITE TÜRRAHMEN (Sc)	EMPFOHLENE BREITE DER MONTAGEÖFFNUNG (Sm)	GESAMTBREITE TÜRRAHMEN (Sc)	EMPFOHLENE BREITE DER MONTAGEÖFFNUNG (Sm)*	GESAMTHÖHE TÜRRAHMEN (Hc)	EMPFOHLENE HÖHE DER MONTAGEÖFFNUNG VOM NIVEAU "0" (Hm)	GESAMTHÖHE TÜRRAHMEN (Hc)	EMPFOHLENE HÖHE DER MONTAGEÖFFNUNG VOM NIVEAU "0" (Hm)
80	918	938	896	916	2087	2097	2076	2086
80+30	1209	1229	1187	1207				
80+40	1309	1329	1287	1307				
80+50	1409	1429	1387	1407				
90 E	1031	1051	1009	1029				
90 E +30	1322	1342	1300	1320				
90 E +40	1422	1442	1400	1420				
90 E +50	1522	1542	1500	1520				
100 E	1131	1151	1109	1129				
100 E +30	1422	1442	1400	1420				
100 E +40	1522	1542	1500	1520				
100 E +50	1622	1642	1600	1620				

* ENTHÄLT MONTAGEABSTAND 10 mm

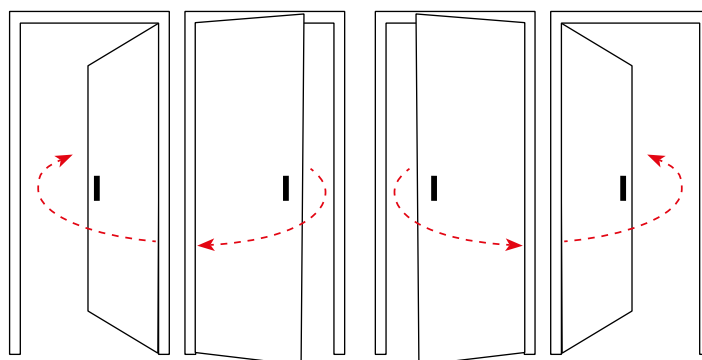

LINKE TÜREN

RECHTE TÜREN

OPTIMA 50

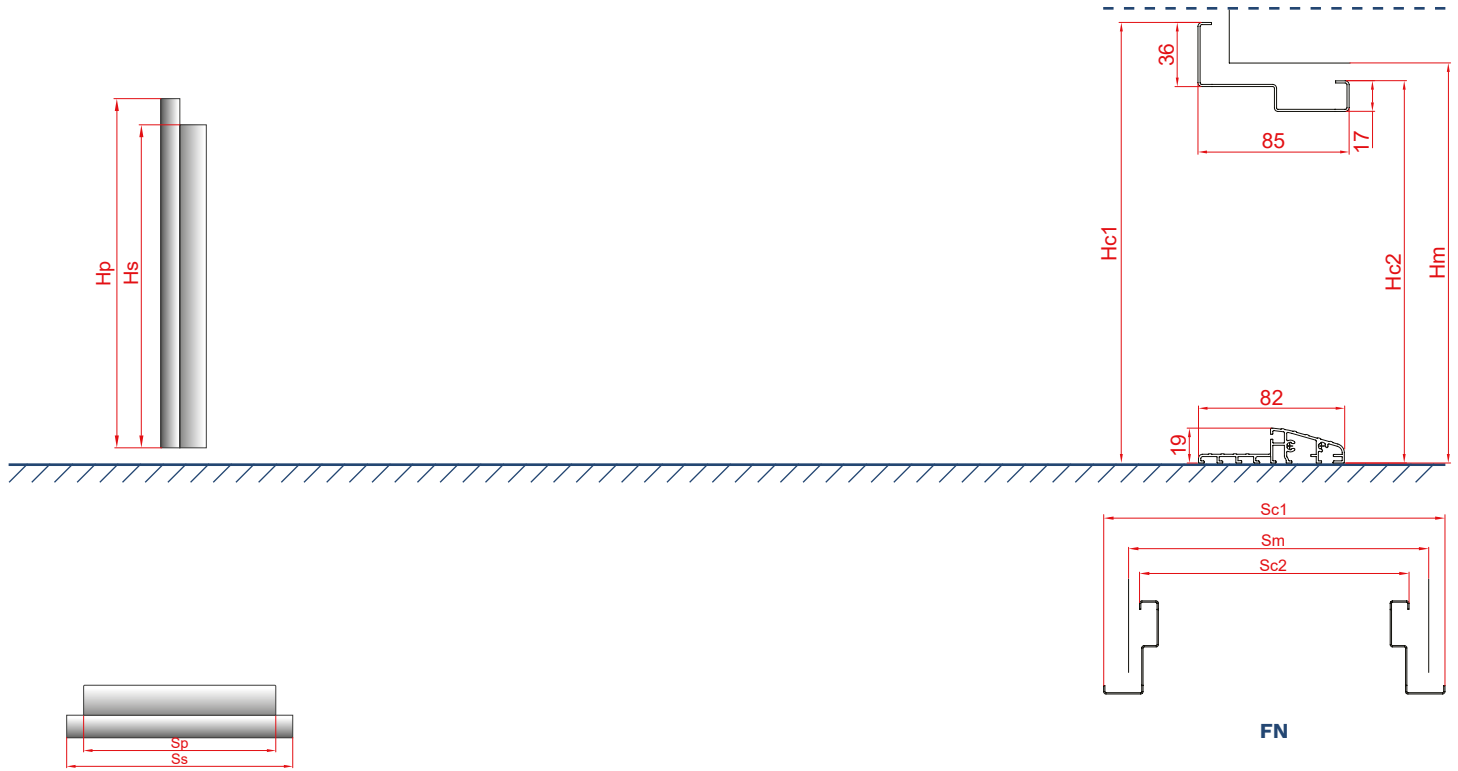

DUO-TÜREN

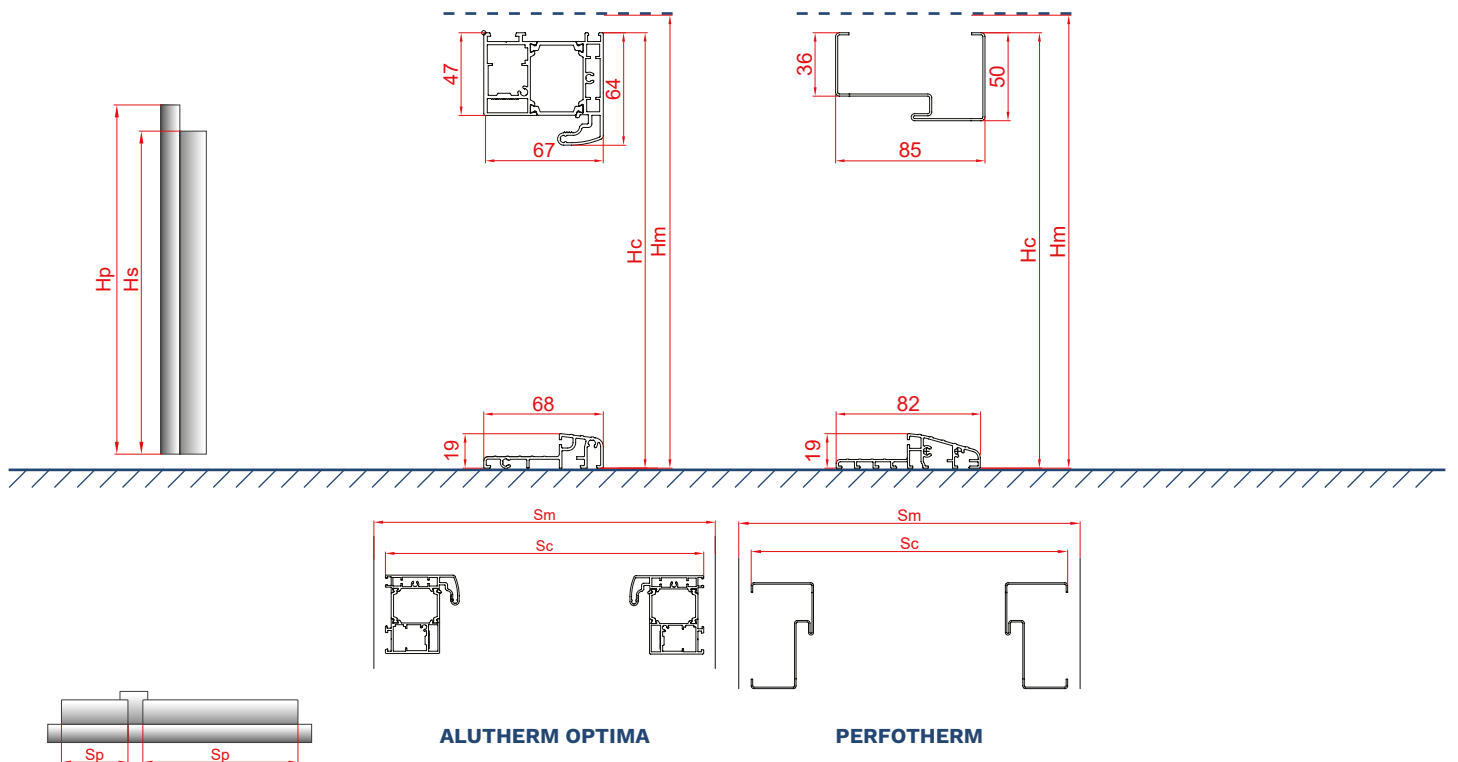

* TÜREN IN DUNKLEN FARBEN SIND NICHT AN ORTEN MIT LANGER UND DIREKTER SONNENEINSTRALUNG EINZUBAUEN. TÜREN; EINGEBAUT ALS AUSSEN-EINGANGSTÜREN AN ORTEN MIT DIREKTER EINWIRKUNG VON WITTERUNGSFAKTOREN (REGEN, WIND, ETC.) SOLLTEN NACH AUSSEN ÖFFNENDE TÜREN SEIN. IM FALLE VON TÜREN; DIE ALS SMA AUSSEN-EINGANGSTÜREN EINGEBAUT WERDEN, IST DER EINSATZ EINER ÜBERDACHUNG ERFORDERLICH.

**INSPIRATIONEN
SIND IN REALISIERUNGEN ZU FINDEN**



GERDA[®] INSPIRATIONEN SIND IN REALISIERUNGEN ZU FINDEN





Gerda Sp. z o.o.

Sokołów, ul. Sokołowska 49

05-806 Komorów

Tel.: (+48 22) 329 10 30

www.gerda.pl

Händler:

Dieser Katalog stellt kein Angebot im Sinne der Rechtsvorschriften dar und wird nur zu informativen Zwecken veröffentlicht.

Die Firma Gerda, die sich stets um die Verbesserung der Qualität ihrer Produkte und Dienstleistungen bemüht, behält sich das Recht vor, (ohne vorherige Ankündigung) Änderungen an Produkten vorzunehmen, die aufgrund des Verfahrens der Vorbereitung von Drucksachen in diesem Material möglicherweise nicht enthalten sind.

Trotz der Bemühungen um genaue Kontrolle der präsentierten Informationen sind Sach- oder Druckfehler möglich.

Die im Katalog dargestellten Farben können aufgrund einer anderen Technik der Farbwiedergabe im Druckprozess vom Original abweichen. Inhaber des Urheberrechts an diesem Katalog und an den Gerda Logos und Grafikelementen ist die Gerda Sp. z o.

Ohne vorherige Zustimmung der Gerda Sp. z o.o. ist es untersagt, jegliche in diesem Katalog befindlichen Inhalte und Materialien zu kopieren und weiterzugeben.