

GERDA[®]

PREMIUM DOOR MANUFACTURER



APARTMENT DOORS

STAR | PREMIUM | COMFORT | ENJOY

COMPANY INFORMATION	3
NEW ARRIVALS	4
ELITE PACKAGE (PANEL CONSTRUCTION DOOR)	5
COMFORT AND SAFETY	6
TEDEE POWERED BY GERDA	7
GERDA STAR 60 DOOR	10-13
GERDA PREMIUM 60 DOOR	14-17
GERDA COMFORT 60 DOOR	18-21
GERDA ENJOY DOOR	22-25
PORTALS AND DOOR TRIMS	26
STEEL CLAMPS	29
ACCESSORIES AND FIXTURES	30
DOOR COLOURS	34
DOOR AND FRAME DIMENSIONS	38
INSPIRATIONS	46

PRODUCTS WITH THE BRAND'S QUALITY GUARANTEE



GERDA[®]

We have created products that have already become iconic and millions of Poles have welcomed them in their homes. GERDA is associated with safety, reliability and comfort. We do our best to continuously improve our products.

POLISH MANUFACTURER WITH TRADITION AND EXPERIENCE



35 YEARS GERDA[®]

GERDA is a Polish manufacturer of doors, locks, fittings and sectional garage doors. The company has been appreciated for over 35 years by partners, assemblers and users. We design and create with passion! Our customers receive modern, durable and reliable products. We are worthy of trust!

PRODUCTS KNOWN ACROSS POLAND

DOORS



FITTINGS



GATES



NEW ARRIVALS

OUR STANDARD PROVIDES YOU WITH MORE THAN OTHERS

GERDA ELITE PACKAGE

YOU DECIDE WHAT YOUR DOOR WILL LOOK LIKE

WITH OUR CUSTOMERS IN MIND, THE TEAM OF ENGINEERS AND CONSTRUCTORS IS CONSTANTLY WORKING ON MODIFICATIONS THAT IMPROVE SAFETY AND COMFORT OF USE

PANEL-TYPE DOORS HAVE A MULTI-LAYER LEAF WITH A STEEL BOX BODY AND REPLACEABLE CLADDINGS ON BOTH SIDES

ADJUSTABLE 3D HINGE



The new hinges with 3-way adjustments are now standard in the COMFORT 60 and PREMIUM 60 lines. This solution provides a very convenient and quick way of adjusting the door, without having to dismantle the leaf from the frame.

ADJUSTABLE LATCH CATCH OF THE HANDLE



An adjustable latch catch is offered in all the doors from the apartment doors offer. It enables the smooth adjustment of the leaf pressure to the gaskets. Thanks to this solution, adjusting the pressure is always easy (reduce or increase the pressure on the gasket).

IMPROVED ACOUSTIC PACK

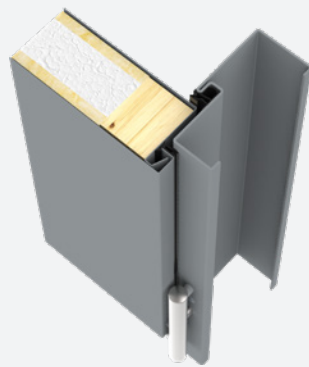

The use of innovative gaskets in leaves and FRAMES that form one plane provides very good acoustic properties. Noise from the staircase does not penetrate the apartment.



PREMIUM LOCKS AS STANDARD



All apartment doors have been equipped with PREMIUM locks, in which deadbolts with a safe design have been reinforced by 30%. Additionally, market-unique reinforcement of internal deadbolts made of hardened steel has been applied.



PANEL STRUCTURE

Panel doors will be perfect as apartment front doors and their appearance can be customised. The panels are mounted to the steel body making the door sturdier and bracing the leaf. Upon the customer's request, the panels can vary in colour on the inside and the outside. The well-thought-out method of mounting the panels to the body enables easy disassembly and replacement in case of damage or rearrangement, without the need for a costly replacement of the entire door.



LARGE SELECTION OF ESCUTCHEONS AND HANDLES

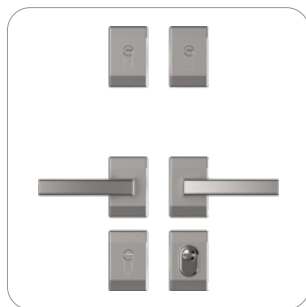

The possibility to customise the appearance of the door thanks to a wide range of oval, oblong and split ESCUTCHEONS in the COMFORT and PREMIUM series.



DISMANTLE THE EXISTING PANEL



CHOOSE A COLOUR FROM THE ELITE PACKAGE



ENJOY THE NEW LOOK OF YOUR DOOR

COMFORT AND SAFETY

WHAT YOU SHOULD KNOW ABOUT GERDA DOORS

TURN YOUR SMARTPHONE INTO A SMART DOOR LOCK



ANTI-BURGLARY

All our doors are structurally reinforced, with solutions that make it difficult to force them open. They are also equipped with an anti-burglary lock cylinder, which is what GERDA is renowned for. However, for the antiburglary parameters to be confirmed, the door must pass specialised tests and trials for RC2, RC3 and RC4 classes, concluded with the issuance of an appropriate certificate. GERDA doors possess such certificates and approvals. They can be downloaded at any time from www.gerda.pl. The doors offered by GERDA can be bought in class RC2, RC3 and RC4 (detailed explanations at the bottom of the page).



EXCELLENT ACOUSTIC COMFORT

When buying a door, acoustic comfort must be taken into consideration in order to ensure that as little sound as possible comes into our apartment. The sound reduction index (Rw) is expressed in dB (decibels). The higher the value of the index, the better the sound reduction of the door. Our apartment doors have a very good sound reduction index (from 33 to even 47 dB). If there is 80 dB of sound coming from the outside (this corresponds to loud music) it will be reduced from 33-47 dB to even 33 dB, which is the level of a silent conversation.



FIRE PROTECTION

In our offer of GERDA apartment doors, you can also choose a fire protection pack (available in the PREMIUM 60 series). Fire-resistant doors are designed to stop the spread of fire and smoke. Products with the aforementioned properties are marked with the symbol EI (fire integrity criterion - E and fireproof insulation - I). GERDA offers doors with EI30, EI45 and EI60 parameters which mean the protection lasts for 30, 45 and 60 minutes respectively. The owner of such a door has a guarantee that the flames will not pass through the door for the indicated time and that the door temperature will not cause the fire to spread. The smoke-proofing class is S200.



OPEN DOORS WITH YOUR SMARTPHONE

Open and close doors and monitor door lock status from any place around the world. With the automatic opening feature, you don't need to take your phone out from your purse or pocket. The lock will detect your presence and let you in. The self-locking feature works based on the same principle.

HIGH-PERFORMANCE BATTERY

Gerda engineers, in collaboration with the South Korean Research Institute, have developed a small dedicated high-performance battery. It powers the mechanism for six months of operation. And when in need of recharging, the lock will let you know as you can charge the battery overnight.

SAFETY WARRANTY

The lock actuating mechanism is an innovative, patented design developed by Gerda engineers. The software was created by Tedee IoT experts. An intuitive app lets you keep track of who and when has locked or unlocked the door. It also offers a virtual key allocation feature.

SET

TEDEE LOCK + TEDEE BRIDGE + CLASS 6 LOCK CYLINDERS

PRICE

1650 PLN (extra charge)

ANTI-BURGLARY CLASSES

RC2 CLASS

- PLIERS
- WEDGE
- HAMMER

RC3 CLASS

- STEEL CROWBAR
- WEDGE
- HAMMER
- MECHANICAL DRILL

RC4 CLASS

- HEAVY HAMMER
- AXE
- GOUGE
- CHISEL
- DRILL



CLASS 6 LOCK CYLINDERS INCLUDED

- ✓ ANTI-BURGLARY TUMBLER LOCK INSERT. NEW LOCK INSERT DESIGN SECURED AGAINST 'LOCK BUMPING', WITH EFFECTIVE DRILL OPENING PROTECTION.



INSTALL A TEDEE LOCK

- ✓ SLIDE THE LOCK ONTO A GERDA INSERT, ADJUST THE LOCK POSITION AND SECURE IT WITH ONE BOLT. INSTALLATION TAKES NO MORE THAN TWO MINUTES. INSPECT TO SEE WHETHER THE BOLTS SLIDE UPON TURNING THE KNOB.



INSTALL THE SMARTPHONE APP

- ✓ DOWNLOAD THE TEDEE APP FROM APPLE STORE OR GOOGLE PLAY. SIGN UP AND ACTIVATE YOUR BLUE-TOOTH, LOCATION SERVICE AND INTERNET ACCESS. ADD YOUR LOCK AND ENTER THE ACTIVATION CODE.



CONNECT THE BRIDGE

- ✓ FIND A FREE POWER SOCKET NEXT TO THE TEDEE LOCK AND PLUG THE BRIDGE IN. THIS WILL ENABLE YOU TO CONTROL THE LOCK OVER THE INTERNET FROM WHEREVER YOU ARE.



STAR 60



ANTI-BURGLARY PROTECTION CLASS RC4



LEAF THICKNESS 60 / 70 mm



SOUND REDUCTION INDEX 43 / 47 dB



ELITE PANEL CONSTRUCTION

PREMIUM 60



ANTI-BURGLARY PROTECTION CLASS RC2 / RC3 / RC4



LEAF THICKNESS 60 / 70 mm



SOUND REDUCTION INDEX 42 dB



FIRE RESISTANCE CLASS EI30 / EI45 / EI60
AND SMOKE TIGHTNESS CLASS S₂₀₀



ELITE PANEL CONSTRUCTION

COMFORT 60



ANTI-BURGLARY PROTECTION CLASS RC2 / RC3



LEAF THICKNESS 60 mm



SOUND REDUCTION INDEX 30 / 33 dB

ENJOY



ANTI-BURGLARY PROTECTION CLASS RCIN / RC2



LEAF THICKNESS 46 mm



SOUND REDUCTION INDEX 32 dB



UNIQUE TUBULAR KEY

Patented RIM6000 lock cylinder with a tubular key with over 4 billion code combinations.

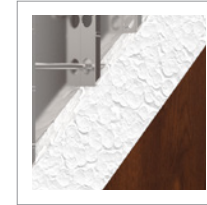

FILLING

HCFC-free polyurethane foam with a soundproofing plate providing excellent acoustic performance.



LATTICE

A lattice with thickened steel channel bars and hardened rods in the steel body of the door leaf.

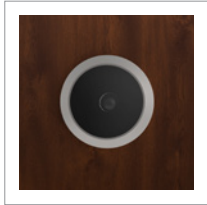

VIEWER

Wide-angle viewer as standard with a very good optical performance.



ADDITIONAL LOCK

Additional class 6 lock with a class 5 or class 6 lock cylinder.

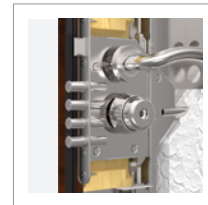

MAIN LOCK 14 LOCKING POINTS

Unique class 7 main lock with 11 mobile and thickened bolts.



AUXILIARY LOCKS

Auxiliary upper and lower locks controlled from the main lock.



3 THREE-PIECE HINGES

Reinforced three-piece hinges with a disassembly lock and elegant caps.

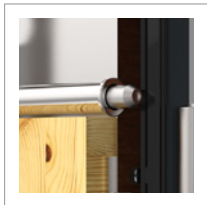

3 MOVABLE DEADBOLTS

Reinforced horizontal deadbolts on the hinge sides controlled from the main lock.

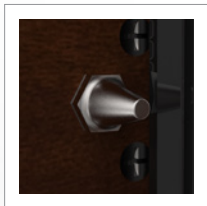

3 FIXED BOLTS

Fixed bolts protecting against forcing the door.

PARAMETERS

RC	ANTI-BURGLARY PROTECTION CLASS	RC4
mm	LEAF THICKNESS / WITH ELITE PACKAGE	60 / 70* (mm)
dB	SOUND REDUCTION INDEX / ELITE PACKAGE*	43 / 47* (dB)
Grid	LEAF STRUCTURE	POLYURETHANE FOAM FILLING + SOUNDPROOFING PACK + LATTICE
Door	DOOR SIZES	80N, 80, 90N, 90E, 100E*

*EXTRA CHARGE

DOOR FRAMES

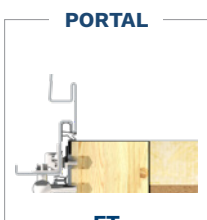
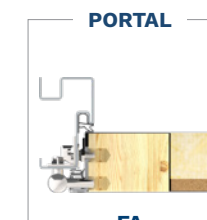
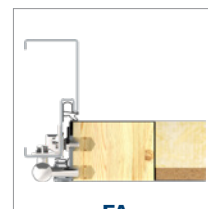



W00 PLAIN

SIZE	80N	80	90N	90E	100E
------	-----	----	-----	-----	------

MODEL	STAR 60
-------	---------

PLAIN	3 350 PLN
-------	-----------

RC4 STANDARD EQUIPMENT

- STAR 60 DOOR LEAF (43 dB)
- DOOR FRAME WITH SEAL
- 3-PIECE HINGES WITH CAPS MATCHING FITTING'S COLOUR
- LAMINATED THRESHOLD WITH SEAL 19 mm / 32 mm
- FITTINGS SET WITH LOCK CYLINDER PROTECTION
- WIDE-ANGLE VIEWER
- TECHNO HANDLES
- CLASS 6 MAIN LOCK CYLINDER
- CLASS 5 ADDITIONAL LOCK CYLINDER

EXTRA CHARGES

SIZE 100E	350 PLN	2.4" ELECTRONIC VIEWER	140 PLN
TWO-COLOUR DOOR	500 PLN	4.3" ELECTRONIC VIEWER	375 PLN
DOOR SHORTENING (20, 30, 40, 50, 60, 70 mm)	215 PLN	NORWEGIAN WOODEN THRESHOLD WITH SEAL 19 mm	45 PLN
ELITE PACKAGE – FLAT PANEL	750 PLN	INOX THRESHOLD 19 mm / 32 mm	45 PLN
ELITE PACKAGE – PATTERN PANEL	1 100 PLN	NORWEGIAN WOODEN THRESHOLD: 28 mm WITH ALUMINUM STRIP AND SEAL 35 mm WITH WOODEN STRIP AND SEAL ¹	75 PLN
SINGLE-SIDE PATTERN TOKIO 1, TOKIO 2	325 PLN	RIGID CHAIN (WITHOUT ELITE PACKAGE) ²	250 PLN
DOUBLE-SIDE PATTERN TOKIO 1, TOKIO 2	500 PLN	TEDEE SET	1 650 PLN
HANDLE-KNOB	50 PLN		
ADDITIONAL CLASS 6 LOCK CYLINDER	90 PLN		

¹ For frames extended by 6 mm, with the DPO mounting system
² For frames with the DPO mounting system (frame dowel joint), metal doors

DOOR LEAF DESIGNS AVAILABLE WITH ELITE PACKAGE



RHH

RLF

VA3

VA4

METAL DOOR LEAF DESIGNS AVAILABLE



TOKIO 1

TOKIO 2

DOOR FRAMES

FA



FT



THRESHOLDS

LAMINATED



HEIGHT 19 mm
INCLUDED IN PRICE

NORWEGIAN WOODEN (brown, light brown, light)

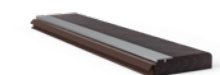

WITH SEAL HEIGHT 19 mm
EXTRA CHARGE 45 PLN

INOX

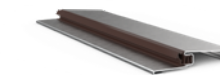

HEIGHT 19 mm
EXTRA CHARGE 45 PLN

LAMINATED* / INOX**

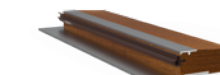

WITH ALUMINUM STRIP AND SEAL, HEIGHT 28 mm
EXTRA CHARGE 75 PLN

LAMINATED* / INOX**

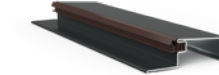

HEIGHT 32 mm
*** INCLUDED IN PRICE**
**** EXTRA CHARGE 45 PLN**

WITH WOODEN STRIP AND SEAL, HEIGHT 35 mm

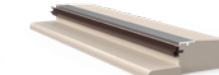

EXTRA CHARGE 75 PLN

FITTINGS

RC4 RIM 6000 TECHNO

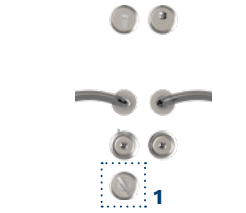

DUO-COLOUR FITTINGS SATIN NICKEL



1. RIGID CHAIN (OPTIONAL)

DOOR COLOURS (INCLUDING PANELS, SKIRTING BOARDS AND FRAMES OF THE ELITE PACKAGE)

ALPINE WALNUT FRR	BRAZIL WALNUT FRB	LIGHT WALNUT FRP	GOLDEN OAK FDE	WINCHESTER FDW	LIGHT WENGE FEJ
WHITENED WENGE FBJ	WHITE FSB	STEEL GREY FKZ	ANTHRACITE FKG	DARK ANTHRACITE FKF	BLACK FKC

ADDITIONAL COLOURS OF ELITE PACKAGE PANELS

SILICON FKL FLAT DESIGN ONLY	MARBLE FKA FLAT DESIGN ONLY	HAEMATITE FDF FLAT DESIGN ONLY	QUARTZ FKH FLAT DESIGN ONLY	WENGE FEE
------------------------------------	-----------------------------------	--------------------------------------	-----------------------------------	--------------

ADDITIONAL COLOURS OF SKIRTING BOARDS AND FRAMES OF THE ELITE PACKAGE

GREY FKT	DARK BROWN FKX	WENGE FEE
-------------	-------------------	--------------



PARAMETERS

	ANTI-BURGLARY PROTECTION CLASS	RC2 / RC3* / RC4*
	LEAF THICKNESS / WITH ELITE PACKAGE*	60 / 70* (mm)
	SOUND REDUCTION INDEX	42 (dB)
	FILLING	SPECIAL SOUNDPROOFING PACKAGE
	FIRE RESISTANCE CLASS (FR)*	EI30^{AB} / EI45^B / EI60^A
	SMOKE TIGHTNESS CLASS	S200 (IN THE EI30^{AB} / EI45^B / EI60^A LEAVES)
	DOOR SIZES	80N, 80, 90N, 90Z, 100E^C

* EXTRA CHARGE
A. EI30 AND EI60 AVAILABLE IN RC2 AND RC3 CLASS
B. EI30 AND EI45 AVAILABLE IN RC4 CLASS
C. SIZE 100E NOT AVAILABLE IN RC4 AND EI60 CLASS

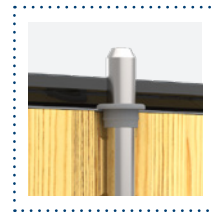

VERTICAL DEADBOLT

Anti-burglary vertical deadbolt controlled from the main lock. Available in the RC3 pack.

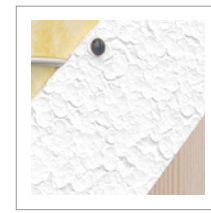

FILLING

Special filling for good acoustic comfort.



HARDENED BARS

Specially developed design of thickened and hardened steel bar protecting against burglary. Available in RC3 and RC4 class.

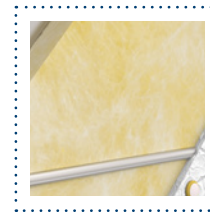

EI30 S200 / EI45 S200 / EI60 S200

PREMIUM 60 doors are also available with the fire-resistant pack.



VIEWER

Wide-angle viewer as standard with a very good optical performance.



ADDITIONAL LOCK

Additional top lock with burglar-proof class 5 or class 6 lock cylinder.

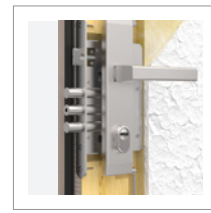

MAIN LOCK

Class 7 main lock with reinforced deadbolt construction with class 5 or class 6 anti-burglary lock cylinder.



AUXILIARY LOCKS

Lower and upper auxiliary locks with a double deadbolt system controlled from the main lock. Available as a pack RC3 (1 pc) (lower) and RC4 (3 pc).

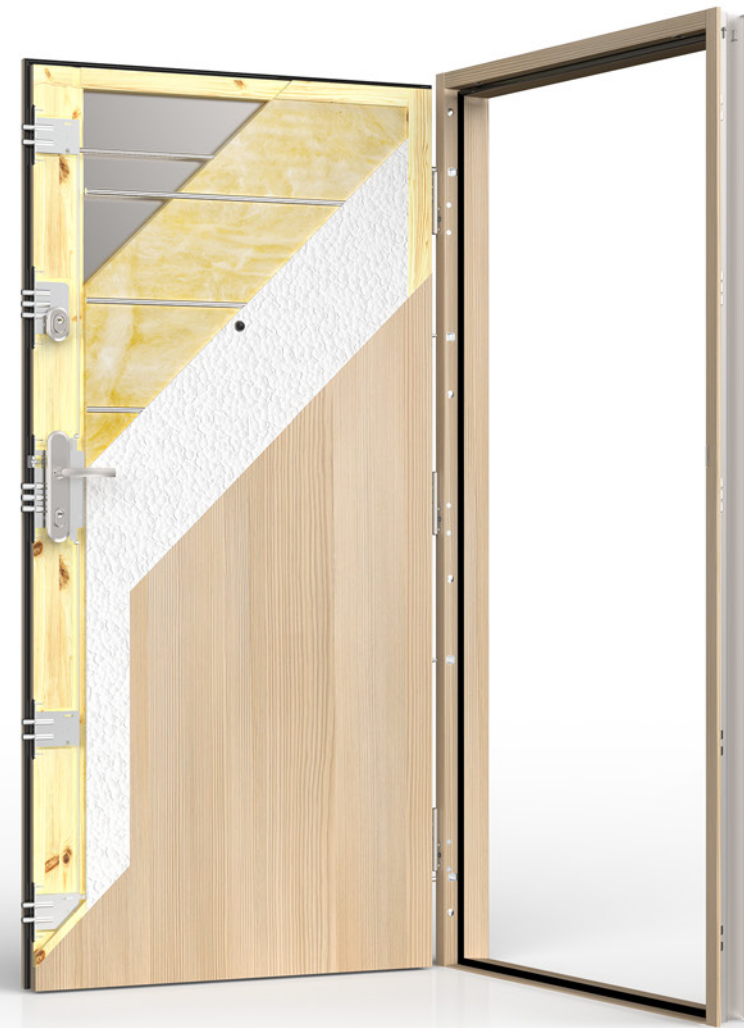

3D HINGE WITH CAPS

Hinges adjustable in three planes with caps matching fitting's colour.



2 MOVABLE DEADBOLTS

Reinforced horizontal deadbolts on the hinge sides controlled from the main lock. (Available in RC4 class).

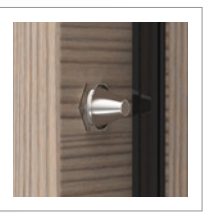

2 FIXED BOLTS

Fixed bolts protecting against forcing the door.

STANDARD EQUIPMENT
 EXTRA CHARGE

DOOR FRAMES

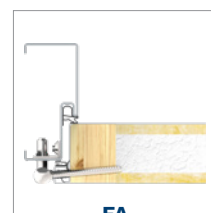

FA



FT

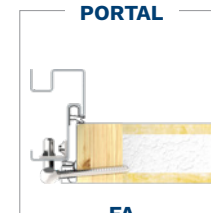

FA



FT



WOO PLAIN

SIZE	80N	80	90N	90Z	100E
MODEL	PREMIUM 60				
PLAIN	2 320 PLN				
RC2 STANDARD ELEMENTS					
• PREMIUM 60 DOOR LEAF (42 dB)	• FITTINGS SET WITH MAIN LOCK CYLINDER PROTECTION				
• DOOR FRAME WITH SEAL	• WIDE-ANGLE VIEWER				
• ADJUSTABLE 3D HINGES WITH CAPS MATCHING FITTING'S COLOUR	• HANDLES (BLOK, BERGEN, OSLO)				
• LAMINATED THRESHOLD WITH SEAL 19 mm / 32 mm	• CLASS 5 LOCK CYLINDERS IN SINGLE KEY SYSTEM				
EXTRA CHARGES					
RC3 PACKAGE	370 PLN	CLASS 6 CYLINDERS IN SINGLE KEY SYSTEM (STANDARD IN RC4 PACKAGE)	180 PLN		
RC4 PACKAGE	630 PLN	2.4" ELECTRONIC VIEWER	140 PLN		
EI30 S ₂₀₀₀	600 PLN	4.3" ELECTRONIC VIEWER	375 PLN		
FIRE PROTECTION PACKAGE INTEGRATED CLOSER	EI45 S ₂₀₀₀ 1 100 PLN	NORWEGIAN WOODEN THRESHOLD WITH SEAL 19 mm	45 PLN		
EI60 S ₂₀₀₀	1 100 PLN	INOX THRESHOLD 19 mm / 32 mm	45 PLN		
SIZE 100E	350 PLN	NORWEGIAN WOODEN THRESHOLD: 28 mm WITH ALUMINUM STRIP AND SEAL	75 PLN		
TWO-COLOUR DOORS	500 PLN	35 mm WITH WOODEN STRIP AND SEAL ¹			
DOOR SHORTENING (20, 30, 40 ³ , 50, 60 ³ , 70 mm) ⁴	215 PLN	RIGID CHAIN (WITHOUT RC4, FIRE PROTECTION AND ELITE PACKAGE) ²	250 PLN		
ELITE PACKAGE – FLAT PANEL	750 PLN	UPPER ESCUTCHEON PROTECTION (STANDARD IN FIRE PROTECTION PACKAGE)	30 PLN		
ELITE PACKAGE – PATTERN PANEL	1 100 PLN	TEDEE SET	1 650 PLN		
SINGLE-SIDE PATTERN TOKIO 1, TOKIO 2	325 PLN				
DOUBLE-SIDE PATTERN TOKIO 1, TOKIO 2	500 PLN				
HANDLE-KNOB	50 PLN				

¹For frames extended by 6 mm, with the DPO mounting system
²For frames with the DPO mounting system (frame dowel joint), metal door
³Not applicable to fire-resistant doors
⁴In RC4 package cutting down in the range of 20, 35 mm

DOOR COLOURS (INCLUDING PANELS, SKIRTING BOARDS AND FRAMES OF THE ELITE PACKAGE)

ALPINE WALNUT	BRAZIL WALNUT	LIGHT WALNUT	GOLDEN OAK	WINCHESTER	LIGHT WENGE
FRR	FRB	FRP	FDE	FDW	FEJ
WHITENED WENGE	WHITE	STEEL GREY	ANTHRACITE	DARK ANTHRACITE	BLACK
FBJ	FSB	FKZ	FKG	FKF	FKC

ADDITIONAL COLOURS OF ELITE PACKAGE PANELS

SILICON	MARBLE	HAEMATITE	QUARTZ	WENGE
FKL	FKA	FDF	FKH	FEE
FLAT DESIGN ONLY	FLAT DESIGN ONLY	FLAT DESIGN ONLY	FLAT DESIGN ONLY	

ADDITIONAL COLOURS OF SKIRTING BOARDS AND FRAMES OF THE ELITE PACKAGE

GREY	DARK BROWN	WENGE
FKT	FKX	FEE

DOOR LEAF DESIGNS AVAILABLE WITH ELITE PACKAGE



RHH

RLF

VA3

VA4

METAL DOOR LEAF DESIGNS AVAILABLE



TOKIO 1

TOKIO 2

1. PROTECTED ESCUTCHEON, STANDARD FOR FIRE PROTECTION
2. NOT AVAILABLE FOR FIRE-RESISTANT DOORS EI30 / EI60 (PROTECTED ESCUTCHEON INCLUDED IN THE DOOR PRICE)
3. RIGID CHAIN (OPTIONAL)

DOOR FRAMES

FA



FT



THRESHOLDS

LAMINATED



HEIGHT 19 mm
INCLUDED IN PRICE

INOX

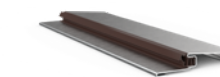

HEIGHT 19 mm
EXTRA CHARGE 45 PLN

LAMINATED* / INOX**

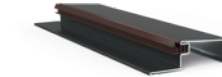

HEIGHT 32 mm
* INCLUDED IN PRICE
** EXTRA CHARGE 45 PLN

NORWEGIAN WOODEN (brown, light brown, light)

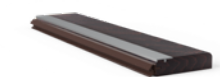

WITH SEAL HEIGHT 19 mm
EXTRA CHARGE 45 PLN

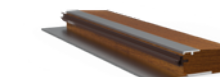

WITH ALUMINUM STRIP AND SEAL, HEIGHT 28 mm
EXTRA CHARGE 75 PLN

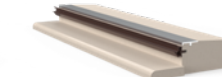

WITH WOODEN STRIP AND SEAL, HEIGHT 35 mm
EXTRA CHARGE 75 PLN

FITTINGS

RC2 RC3 TW300 BERGEN 2 1

RC2 RC3 TD300 BERGEN TD1000 BERGEN 2 1

RC2 TW200 BLOK TW1000 BLOK 2 1

RC2 RC3 TD300 BLOK TD1000 BLOK 2 1

RC2 OSLO 2 1

FITTINGS COLOUR
BERGEN, BLOK
PLATIN ANODA
SILVER ANODA
BLACK ANODA

FITTINGS COLOUR
OSLO
SATIN NICKEL



VERTICAL DEADBOLT

Anti-burglary vertical bar controlled from the main lock. Available in the RC3 package.

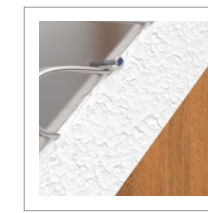

FILLING

Special filling providing good acoustic comfort.



BARS

Specially developed design of thickened and hardened steel bar protecting against burglary. Available in RC3 class.

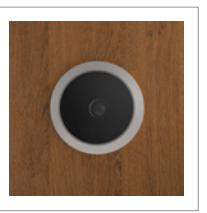

VIEWER

Wide-angle viewer as standard with very good optical parameters.

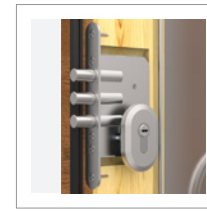

ADDITIONAL LOCK

Additional class 6 top lock with an anti-burglary class 5 or 6 lock cylinder.

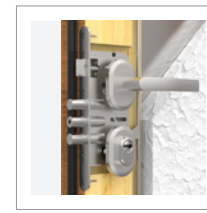

MAIN LOCK

Class 7 main lock with thickened and reinforced deadbolt with class 5 or class 6 anti-burglar lock cylinder.

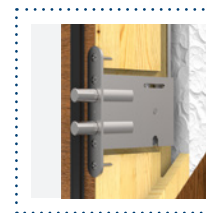

AUXILIARY LOCK

Bottom auxiliary lock with double deadbolt system controlled from the main lock. Available in RC3 pack.

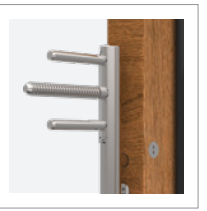
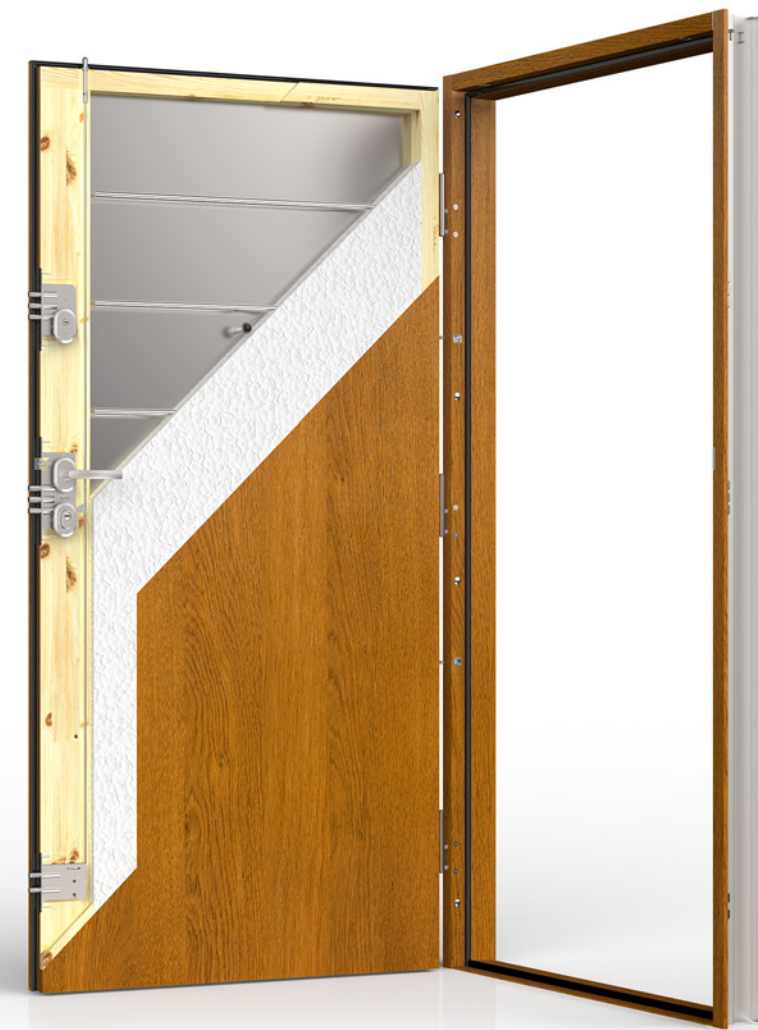

3D HINGE WITH CAPS

Hinges adjustable in three planes with caps matching fitting's colour.

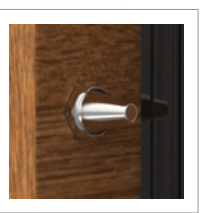

2 FIXED BOLTS

Fixed bolts protecting against forcing the door.

PARAMETERS

RC	ANTI-BURGLARY PROTECTION CLASS	RC2 / RC3*
mm	LEAF THICKNESS	60 (mm)
dB	SOUND REDUCTION INDEX	30 / 33 (dB)
Grid	FILLING	SOUNDPROOFING PACKAGE
Door	DOOR SIZES	80N, 80, 90N, 90Z, 100E*

* EXTRA CHARGE

DOOR FRAMES

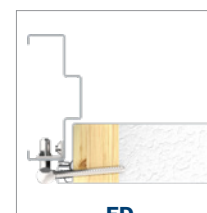

FD



FN

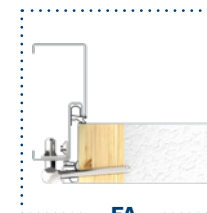

FA



FT

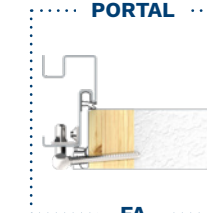

FA

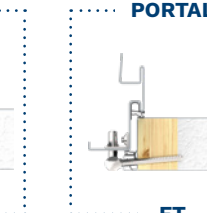

FT

STANDARD EQUIPMENT

EXTRA CHARGE



WOO PLAIN

SIZE	80N	80	90N	90Z	100E
------	-----	----	-----	-----	------

MODEL **COMFORT 60**

PLAIN 1930 PLN

RC2 STANDARD ELEMENTS

- COMFORT 60 DOOR LEAF (30 dB)
- DOOR FRAME WITHOUT SEAL
- ADJUSTABLE 3D HINGES WITH CAPS MATCHING FITTING'S COLOUR
- LAMINATED THRESHOLD WITH SEAL 19 mm / 32 mm
- FITTINGS SET WITH MAIN LOCK CYLINDER PROTECTION
- WIDE-ANGLE VIEWER
- HANDLES (BLOK, BERGEN, OSLO)
- CLASS 5 LOCK CYLINDERS IN SINGLE KEY SYSTEM

EXTRA CHARGES

RC3 PACKAGE	370 PLN	CLASS 6 CYLINDERS IN SINGLE KEY SYSTEM	180 PLN
SOUNDPROOFING PACKAGE 33 dB	160 PLN	2.4" ELECTRONIC VIEWER	140 PLN
DOOR FRAME WITH SEAL	175 PLN	4.3" ELECTRONIC VIEWER	375 PLN
SIZE 100E	350 PLN	NORWEGIAN WOODEN THRESHOLD WITH SEAL 19 mm	45 PLN
TWO-COLOUR DOORS	675 PLN	INOX THRESHOLD 19 mm / 32 mm	45 PLN
DOOR SHORTENING (20, 30, 40, 50, 60, 70 mm)	215 PLN	NORWEGIAN WOODEN THRESHOLD: 28 mm WITH ALUMINUM STRIP AND SEAL 35 mm WITH WOODEN STRIP AND SEAL ¹	75 PLN
SINGLE-SIDE PATTERN TOKIO 1, TOKIO 2	325 PLN	RIGID CHAIN ²	250 PLN
DOUBLE-SIDE PATTERN TOKIO 1, TOKIO 2	500 PLN	TEDEE SET	1 650 PLN
HANDLE-KNOB	50 PLN		
UPPER ESCUTCHEON PROTECTION	30 PLN		

¹For frame extended by 6 mm, with the DPO mounting system
²For frames with the DPO mounting system (frame dowel joint), metal door

INSERTS FOR METAL DOORS AVAILABLE



TOKIO 1



TOKIO 2

1. RIGID CHAIN (OPTIONAL)

DOOR FRAMES

FD



FN



FA*



FT*



* EXTRA CHARGE 175 PLN

THRESHOLDS

LAMINATED



HEIGHT 19 mm
INCLUDED IN PRICE

INOX

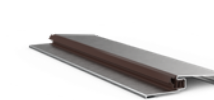

HEIGHT 19 mm
EXTRA CHARGE 45 PLN

LAMINATED* / INOX**

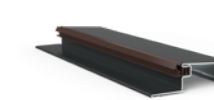

HEIGHT 32 mm
* INCLUDED IN PRICE
** EXTRA CHARGE 45 PLN

NORWEGIAN WOODEN (brown, light brown, light)

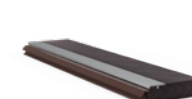

WITH SEAL
HEIGHT 19 mm
EXTRA CHARGE 45 PLN

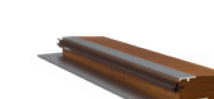

WITH ALUMINUM STRIP AND SEAL, HEIGHT 28 mm
EXTRA CHARGE 75 PLN

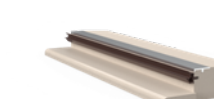

WITH WOODEN STRIP AND SEAL, HEIGHT 35 mm
EXTRA CHARGE 75 PLN

DOOR COLOURS

ALPINE WALNUT FRR	BRAZIL WALNUT FRB	LIGHT WALNUT FRP	GOLDEN OAK FDE	WINCHESTER FDW	LIGHT WENGE FEJ
WHITENED WENGE FBJ	WHITE FSB	STEEL GREY FKZ	ANTHRACITE FKG	DARK ANTHRACITE FKF	BLACK FKC

FITTINGS

RC2 RC3 TW300 BERGEN

RC2 RC3 TD300 BERGEN

RC2 RC3 TW200 BLOK TW1000 BLOK

RC2 RC3 TD300 BLOK

RC2 OSLO

FITTINGS COLOUR
BERGEN, BLOK
PLATIN ANODA



FITTINGS COLOUR
OSLO
SATIN NICKEL





Gerda ENJOY doors are anti-burglary doors dedicated for use inside the buildings as front door to residential apartments. Construction of the Gerda ENJOY door leaf is based on the frame made of an MDF profile reinforced with a steel flat bar and filled with an acoustic package made of natural composite panel. The use of acoustic filling results in increased sound reduction index of 32 dB. Construction of Gerda ENJOY door leaf is covered on both sides with MDF panels. Gerda ENJOY door is equipped with a double set of chamber sealing along the perimeter of the door leaf, the frame and the threshold to ensure good parameters of insulation. The door leaf and the frame are covered with Finish foil with wood-like pattern imitating natural wood grain.

PARAMETERS

RC	ANTI-BURGLARY PROTECTION CLASS	RC1N / RC2*
mm	LEAF THICKNESS	46 mm
dB	SOUND REDUCTION INDEX	32 dB
mm	DOOR SIZES	80, 90
mm	FILLING	SOUNDPROOFING PACKAGE

* EXTRA CHARGE

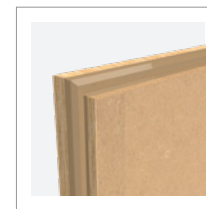

LEAF SEAL



WOODEN DOOR FRAME WITH SEAL

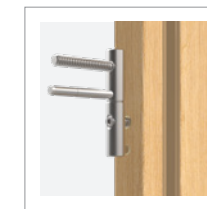

3D HINGES

Adjustable in three planes, 4 pcs.



DOOR THICKNESS

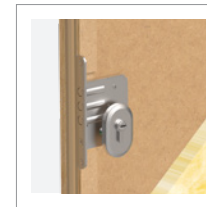

ADDITIONAL LOCK

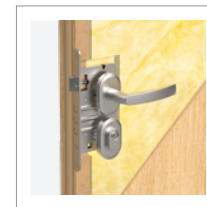

MAIN LOCK



ALUMINIUM THRESHOLD WITH SEAL

WOODEN FRAME

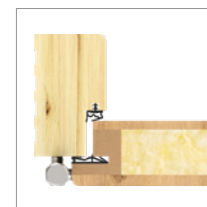

THRESHOLD



ADJUSTABLE LATCH CATCH

Allows seamless adjustment of the door leaf pressure against the gaskets.



3 FIXED BOLTS

Fixed bolts in metal supports protecting against forcing the door.



ACOUSTIC FILLING



FDG MOUNTAIN OAK

SIZE	80	90
-------------	----	----

MODEL	ENJOY
--------------	--------------

PLAIN	1 640 PLN
--------------	-----------

RCIN STANDARD ELEMENTS

- ENJOY DOOR LEAF (30 dB WITH SEAL)
- WOODEN DOOR FRAME WITH SEAL
- ADJUSTABLE 3D HINGES
- ALUMINUM THRESHOLD WITH SEAL 19 mm
- FITTINGS SET WITH MAIN LOCK CYLINDER PROTECTION
- BLOK TW200 SPLIT ESCUTCHEON + HANDLES
- CLASS 2 LOCK CYLINDERS IN SINGLE KEY SYSTEM

EXTRA CHARGES

CUTTING DOWN THE DOOR (30, 50, 70 mm)	✓	WIDE-ANGLE PEEPHOLE	✓
UPPER KEYHOLE PLATE WITH CYLINDER PROTECTION	✓	2.4" ELECTRONIC PEEPHOLE	✓
SET OF CYLINDERS IN CLASS 5 SINGLE KEY SYSTEM (REQUIRED FOR RC2 CLASS)	✓	4.3" ELECTRONIC PEEPHOLE	✓
SET OF CYLINDERS IN CLASS 5 SINGLE KEY SYSTEM (MEETS RC2 CLASS REQUIREMENTS)	✓	TEDEE SET	✓



INSIDE

EXTRA CHARGES

DOOR SHORTENING (30, 50, 70 mm)	215 PLN	UPPER LOCK CYLINDER PROTECTION	30 PLN
CLASS 5 CYLINDERS IN SINGLE KEY SYSTEM (REQUIRED FOR RC2 CLASS)	100 PLN	WIDE-ANGLE VIEWER	25 PLN
CLASS 6 CYLINDERS IN SINGLE KEY SYSTEM (MEETS RC2 CLASS REQUIREMENTS)	280 PLN	2.4" ELECTRONIC VIEWER	165 PLN
		4.3" ELECTRONIC VIEWER	400 PLN
		TEDEE SET	1 650 PLN



FON WALNUT NORTH



FSI SILVER



FDS GREY OAK



FSS SONOMA

FITTINGS
TW200 BLOK



ALUMINUM
THRESHOLD



WOODEN
DOOR FRAME



FITTINGS COLOUR

PLATIN ANODA



SILVER ANODA



BLACK ANODA



DOOR COLOURS



DOOR COLOURS



A SET OF DOOR TRIMS FOR ONE SIDE OF THE DOOR

240 PLN



Door trim (2400 x 80 x 12 mm) – available only with FA door frame.

DOOR TRIMS

This element improves the appearance of the entrance to the apartment. It makes your door stand out among regular doors. It can be applied in GERDA metal doors and with ELITE package in sizes 80N, 80, 90, 90Z, 100E. They are available in sets for one or both door sides.



DOOR PORTALS

This is a special type of door trim, used in the specific frame casing that visibly brings out the elegance of the door. Much like the door trims, the door portal can be used in GERDA metal doors and with ELITE package in sizes 80N, 80, 90, 90Z, 100E. The decision to purchase door portals should be made already when ordering a door, because they are fixed to special frames available at an extra charge.

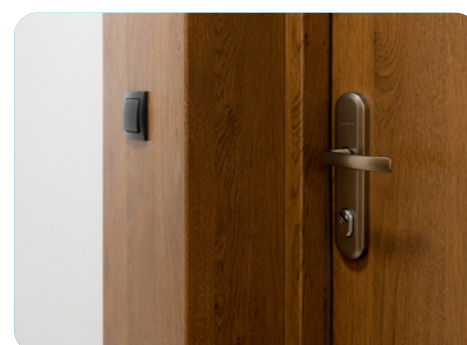

COLOUR PALETTE



DOOR PORTAL

Add up each of the parts **L** – left, **P** – right and **W** – top, to get the total price for the portal. Thickness of the portal is 18 mm for dimension **G** and 12 mm for dimension **L**, **P**, **W**. The overall width of the compound is the sum of the widths of the door (outer frame dimension) and width of the right and the left side of the portal. Similarly, the height of the compound is the sum of the door height with frame and the height of the top side of the portal. NRO board (that does not spread fire) +40% to the given prices.

Wall lining in (mm)	L	P	W
100	250 PLN	250 PLN	225 PLN
110 - 150	270 PLN	270 PLN	250 PLN
160 - 200	310 PLN	310 PLN	285 PLN
210 - 250	345 PLN	345 PLN	325 PLN
260 - 300	385 PLN	385 PLN	365 PLN
310 - 350	410 PLN	410 PLN	400 PLN
360 - 400	450 PLN	450 PLN	430 PLN
410 - 450	-	-	475 PLN
460 - 500	-	-	510 PLN
510 - 550	-	-	540 PLN
560 - 600	-	-	585 PLN
NRO	+40% to the set		

Portal depth "G" in mm stroke every 5 mm		FA with parallel key in mm	Wall thickness in mm		Portal depth "G" in mm stroke every 5 mm		FT with parallel key in mm METAL/ELITE	Wall thickness in mm	
from 50	to 400	80	from 130	to 480	from 50	to 400	70/75	from 120/125	to 470/475

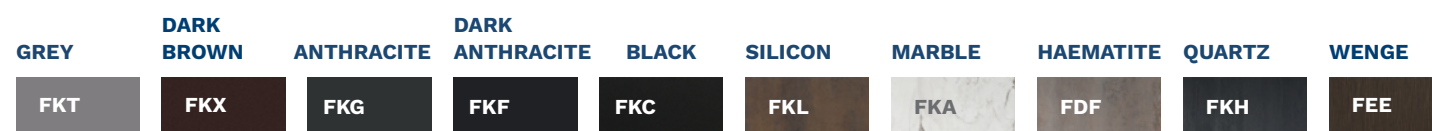

FA ASYMMETRICAL PORTAL FRAME WITH PARALLEL KEY

F = 80 mm

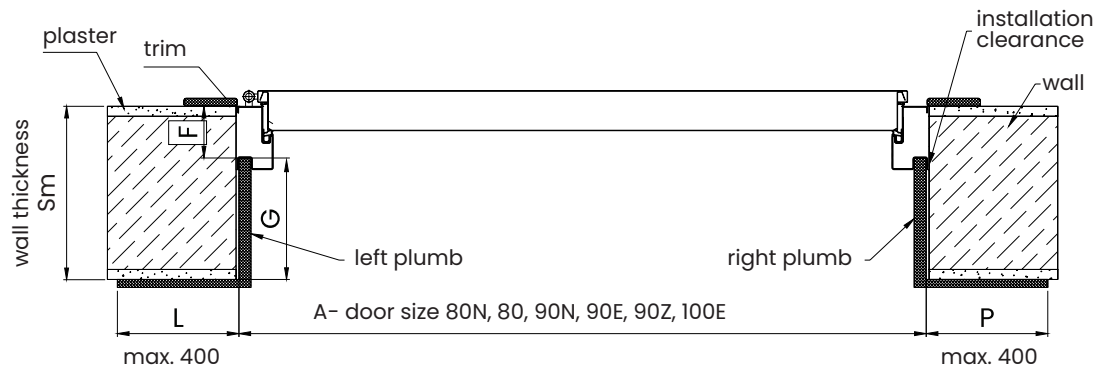

VERTICAL SECTION

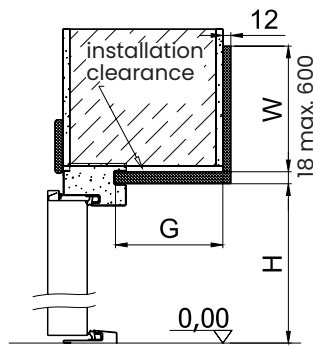

FT CORNER PORTAL FRAME WITH PARALLEL KEY VERTICAL SECTION

F = 70 mm - metal door

F = 75 mm - door with elite package

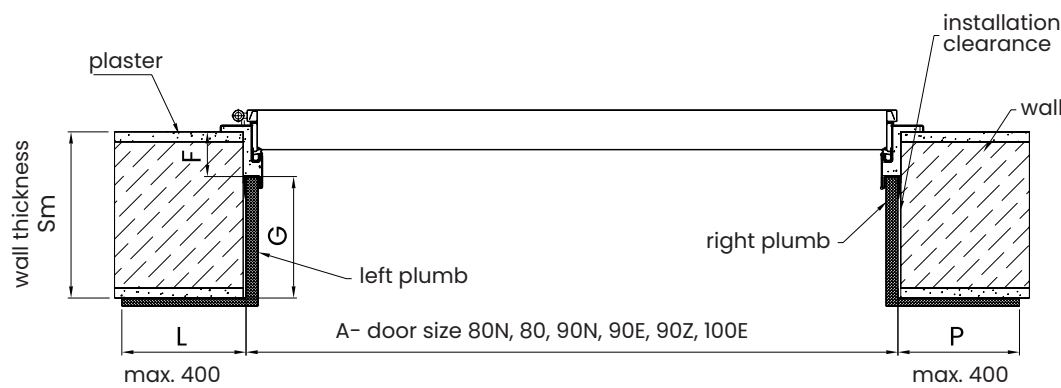

VERTICAL SECTION

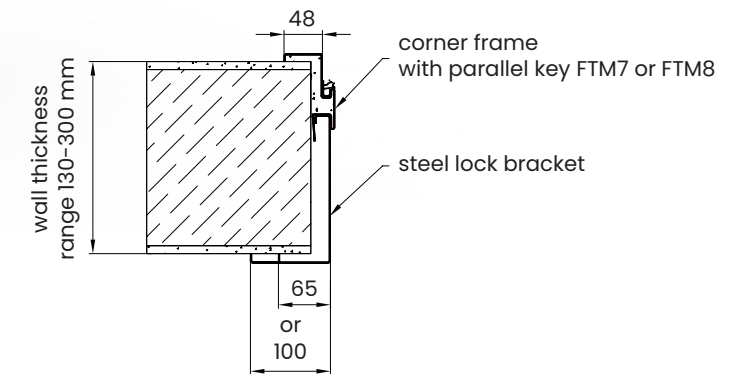
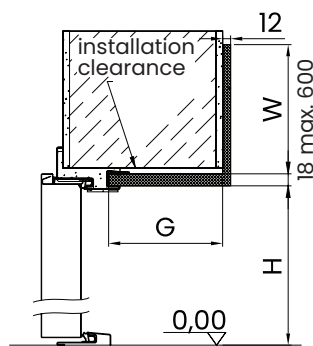

FA DETAIL

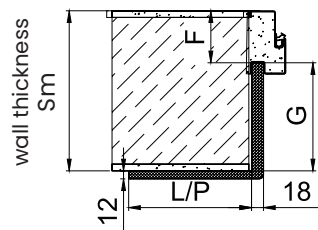

FT DETAIL

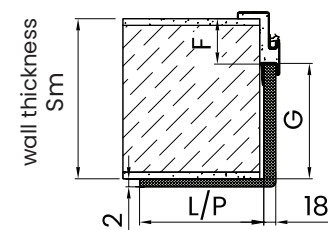

KEY

G – portal depth (mm)
L – width of the left lining (mm)
P – width of the right lining (mm)









W – height of the lining above the frame (mm)
H – height of portal's vertical beam (mm)
For std height H = 2000 mm, FT = 2030 mm, FA = 2058 mm
A – door size: 80N, 80, 90N, 90E, 90Z, 100E
Sm – wall thickness (mm)

G = Sm - F (mm)







CAUTION! Dimensions on the inside of the portal measured from the edge of the wall do not include the thickness of the material.

DOOR FRAME	DOOR MODEL	WALL THICKNESS (in mm) Stroke every 10 mm	WALL LINING IN mm	PRICE
FTM7	Comfort RC2 / RC3 Premium RC2 / RC3	130 - 230	65	380 PLN
FTM7	Comfort RC2 / RC3 Premium RC2 / RC3	240 - 300	65	540 PLN
FTM7	Comfort RC2 / RC3 Premium RC2 / RC3	130 - 230	100	540 PLN
FTM7	Comfort RC2 / RC3 Premium RC2 / RC3	240 - 300	100	710 PLN
FTM8	Premium RC2 / RC3 / EI30 / EI45 / EI60	130 - 230	65	380 PLN
FTM8	Premium RC2 / RC3 / EI30 / EI45 / EI60	240 - 300	65	540 PLN
FTM8	Premium RC2 / RC3 / EI30 / EI45 / EI60	130 - 230	100	540 PLN
FTM8	Premium RC2 / RC3 / EI30 / EI45 / EI60	240 - 300	100	710 PLN









HANDLES

			ENJOY	COMFORT	PREMIUM	STAR
	BERGEN (handle - handle) TD300 BERGEN (handle - handle) TD1000	RC2 / RC3 RC4	—	230 PLN	230 PLN 250 PLN	—
	BERGEN (handle - knob) TD300 BERGEN (handle - knob) TD1000	RC2 / RC3 RC4	—	280 PLN	280 PLN 300 PLN	—
	BERGEN (handle - handle)		—	140 PLN	140 PLN	—
	BLOK (handle - handle) TD300 BLOK (handle - handle) TD1000	RC2 / RC3 RC4	—	230 PLN	230 PLN 250 PLN	—
	BLOK (handle - knob) TD300 BLOK (handle - knob) TD1000	RC2 / RC3 RC4	—	280 PLN	280 PLN 300 PLN	—
	BLOK (handle - handle)		140 PLN	140 PLN	140 PLN	—
	OSLO (handle - handle)		—	140 PLN	140 PLN	—
	TECHNO - (handle - handle) TECHNO - (handle - handle)		—	—	—	170 PLN 220 PLN

ESCUTCHEONS

			ENJOY	COMFORT	PREMIUM	STAR
	BERGEN – split escutcheon with lock cylinder protection TW300	RC2 RC3	—	85 PLN	85 PLN	—
	BERGEN – split escutcheon without lock cylinder protection		—	55 PLN	55 PLN	—
	BLOK – split escutcheon with lock cylinder protection TW1000	RC4	—	110 PLN	110 PLN	—
	BLOK – split escutcheon with lock cylinder protection TW200	RC2	85 PLN	85 PLN	85 PLN	—
	BLOK – split escutcheon without lock cylinder protection		55 PLN	55 PLN	55 PLN	—
	OSLO – split escutcheon with lock cylinder protection	RC2	—	85 PLN	85 PLN	85 PLN
	OSLO – split escutcheon without lock cylinder protection		—	55 PLN	55 PLN	—

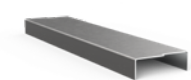
ACCESSORIES

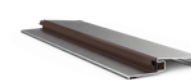
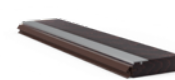
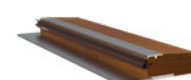
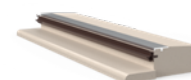
			ENJOY	COMFORT	PREMIUM	STAR
	WIDE-ANGLE VIEWER 50/85		25 PLN	25 PLN	25 PLN	25 PLN
	2.4" ELECTRONIC VIEWER		165 PLN	165 PLN	165 PLN	165 PLN
	4.3" ELECTRONIC VIEWER		400 PLN	400 PLN	400 PLN	400 PLN
	HINGE CAPS FI 18 mm		—	—	—	50 PLN
	3D HINGE CAPS FI 16 mm		—	50 PLN	50 PLN	—
	GEZE DOOR CLOSER GT 1500 STANDARD		—	250 PLN	250 PLN	250 PLN
	GEZE DOOR CLOSER GT 1500 LOCK		—	340 PLN	340 PLN	340 PLN
	GEZE DOOR CLOSER GT 3000 STANDARD		—	750 PLN	750 PLN	750 PLN
	GEZE DOOR CLOSER GT 3000 LOCK		—	980 PLN	980 PLN	980 PLN
	ASSEMBLY THRESHOLD		—	40 PLN	40 PLN	40 PLN
	LAMINATED THRESHOLD 19 mm / 32 mm (MATCHING THE COLOUR OF DOOR FRAME)		—	90 PLN	90 PLN	90 PLN
	INOX THRESHOLD 19 mm / 32 mm		—	135 PLN	135 PLN	135 PLN
	19 mm NORWEGIAN WOODEN THRESHOLD WITH SEAL AND ALUMINIUM COVER, AVAILABLE IN 3 COLOURS (BRONZE, LIGHT BRONZE, LIGHT)		—	135 PLN	135 PLN	135 PLN
	28 mm NORWEGIAN WOODEN THRESHOLD WITH SEAL, ALUMINIUM COVER AND STRIP, AVAILABLE IN 3 COLOURS (BRONZE, LIGHT BRONZE, LIGHT)		—	165 PLN	165 PLN	165 PLN
	35 mm NORWEGIAN WOODEN THRESHOLD WITH SEAL, ALUMINIUM COVER AND WOODEN STRIP, AVAILABLE IN 3 COLOURS (BRONZE, LIGHT BRONZE, LIGHT)		—	165 PLN	165 PLN	165 PLN

ACCESSORIES

ENJOY COMFORT PREMIUM STAR

	FAIL-SECURE ELECTRIC DOOR STRIKE (NC)	RC2 RC3 RC4	—	250 PLN	250 PLN	250 PLN
	FAIL-SECURE FIRE-RESISTANT ELECTRIC DOOR STRIKE (NC)	RC2 RC3 RC4	—	—	1 300 PLN	—
	LAMINATED CLOSURE DOOR TRIM*		—	50 PLN	50 PLN	50 PLN
	NUMERIC KEYPAD FOR ACCESS CONTROL		—	430 PLN	430 PLN	430 PLN
	IMPULSE POWER SUPPLY PSC12015 RECOMMENDED FOR DOORS EQUIPPED WITH AN ELECTRIC STRIKE		—	115 PLN	115 PLN	115 PLN
	MORTAR VARNISH 12 ml		15 PLN	15 PLN	15 PLN	15 PLN
	CYLINDER MAINTENANCE PREPARATION 25 ml		10 PLN	10 PLN	10 PLN	10 PLN
	CYLINDER MAINTENANCE PREPARATION 100 ml		20 PLN	20 PLN	20 PLN	20 PLN
	CYLINDER MAINTENANCE PREPARATION 400 ml		30 PLN	30 PLN	30 PLN	30 PLN
	DOOR MAINTENANCE PREPARATION		39 PLN	39 PLN	39 PLN	39 PLN

*LAMINATED CLOSURE DOOR TRIM | Necessary when self-shortening the leaf in the range (20, 30, 40, 50, 60, 70 and 20.35) and (20 and 35 mm) for RC4. Not available for fire-resistant and ELITE package doors.

LOCK CYLINDERS IN SINGLE KEY SYSTEM

ENJOY

SIZE	MAIN LOCK	ADDITIONAL LOCK	KEYS QUANTITY	CYLINDER CLASS	PRICE
28/45; 28/45	DRIVER	DRIVER	6	CLASS 2	85 PLN
30/45; 30/45	DRIVER	DRIVER	5 + INSTALLER KEYS	CLASS 5	185 PLN
28/45; 30/45	DRIVER	DRIVER	5 + INSTALLER KEYS	CLASS 6	365 PLN

COMFORT 60 | PREMIUM 60

SIZE	MAIN LOCK	ADDITIONAL LOCK	KEYS QUANTITY	CYLINDER CLASS	PRICE
30/50*; 30/50*	GEAR	DRIVER	5 + INSTALLER KEYS	CLASS 5	195 PLN
35/50; 35/50	GEAR	DRIVER	5 + INSTALLER KEYS	CLASS 5	205 PLN
35/55**; 35/55**	GEAR	DRIVER	5 + INSTALLER KEYS	CLASS 5	215 PLN
30/50*; 30/50*	GEAR	DRIVER	5 + INSTALLER KEYS	CLASS 6	375 PLN
35/50; 35/50	GEAR	DRIVER	5 + INSTALLER KEYS	CLASS 6	385 PLN
35/55**; 35/55**	GEAR	DRIVER	5 + INSTALLER KEYS	CLASS 6	395 PLN

* with TW 300 BERGEN escutcheon

** with TW1000 BLOK escutcheon, TW200 BLOK for inward opening doors

PREMIUM 60 WITH ELITE PACKAGE

SIZE	MAIN LOCK	ADDITIONAL LOCK	KEYS QUANTITY	CYLINDER CLASS	PRICE
35/55; 35/55	GEAR	DRIVER	5 + INSTALLER KEYS	CLASS 5	215 PLN
35/55; 35/55	GEAR	DRIVER	5 + INSTALLER KEYS	CLASS 6	395 PLN

* for outward opening doors

** for inward opening doors

STAR 60

SIZE	MAIN LOCK	ADDITIONAL LOCK	KEYS QUANTITY	CYLINDER CLASS	PRICE
—	RIM 6000	—	5	CLASS 6	440 PLN
35/50* ; 55/35**	—	DRIVER	5 + INSTALLER KEYS	CLASS 5	105 PLN
35/50* ; 55/30**	—	DRIVER	5 + INSTALLER KEYS	CLASS 6	195 PLN

* for outward opening doors

** for inward opening doors

STAR 60 WITH ELITE PACKAGE

SIZE	MAIN LOCK	ADDITIONAL LOCK	KEYS QUANTITY	CYLINDER CLASS	CENA
—	RIM 6000	—	5	CLASS 6	440 PLN
35/55	—	DRIVER	5 + INSTALLER KEYS	CLASS 5	115 PLN
35/55	—	DRIVER	5 + INSTALLER KEYS	CLASS 6	205 PLN

* for outward opening doors

** for inward opening doors

CHOOSE A COLOUR FOR YOUR METAL DOOR AND ELITE PACKAGE

CHOOSE A COLOUR FOR YOUR METAL DOOR AND ELITE PACKAGE

DOOR COLOURS INCLUDING PANELS, MOULDING AND FRAMES OF THE ELITE PACKAGE

ALPINE WALNUT

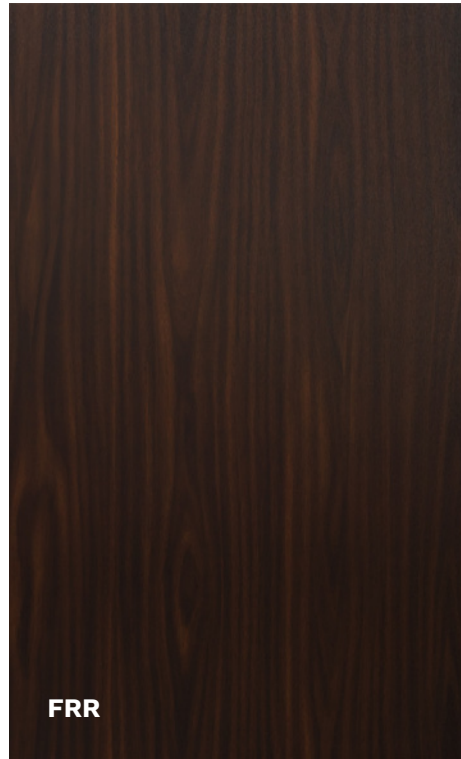

BRAZILIAN WALNUT



LIGHT WALNUT

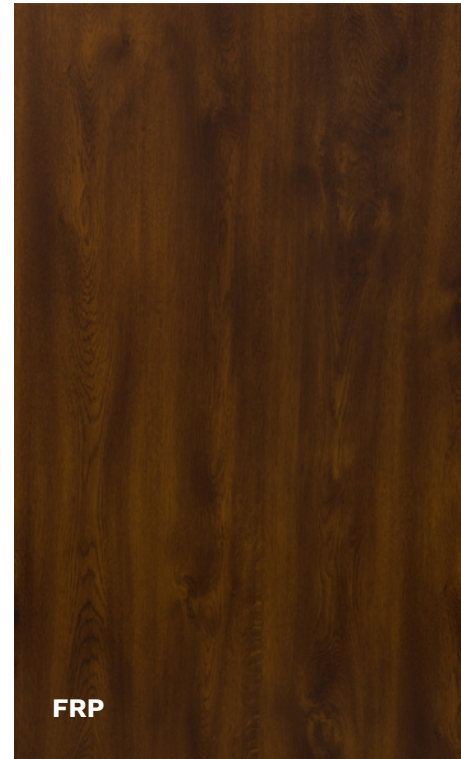

GOLDEN OAK

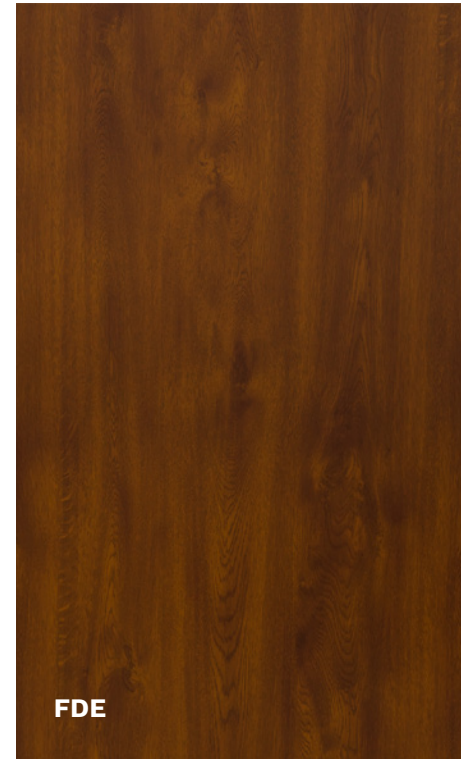

WINCHESTER



LIGHT WENGE



WHITENED WENGE



WHITE

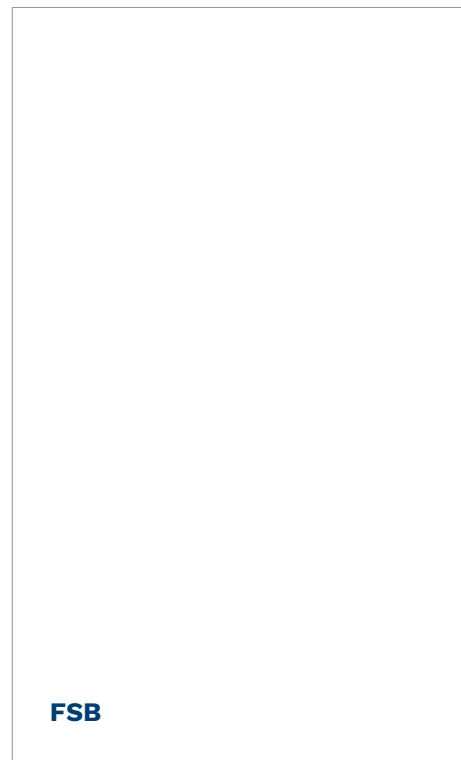

STEEL GREY



ANTHRACITE

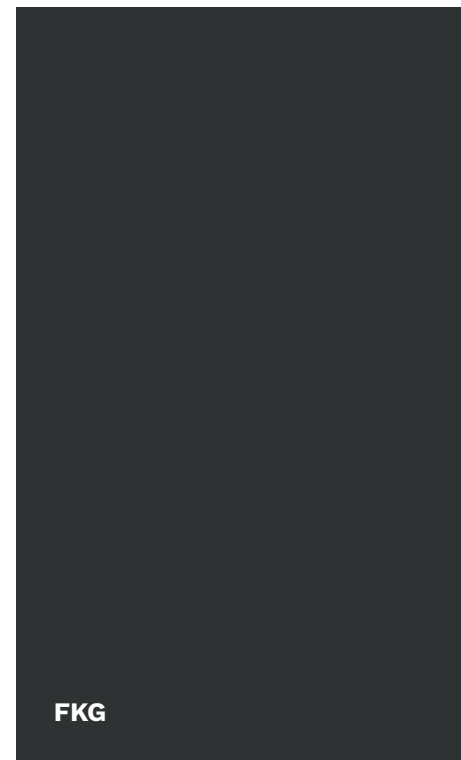

DARK ANTHRACITE



BLACK

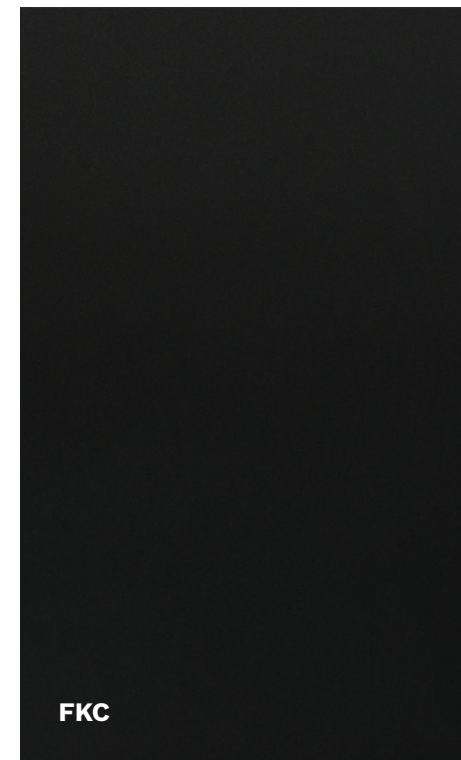

CHOOSE A COLOUR FOR YOUR METAL DOOR AND ELITE PACKAGE

CHOOSE YOUR ENJOY DOOR COLOUR

ELITE PACKAGE

SILICON



MARBLE

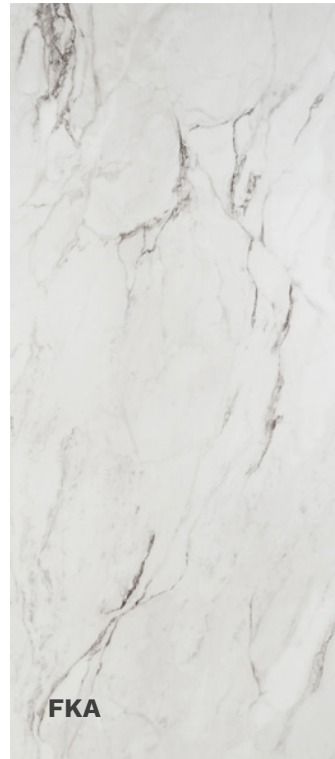

HAEMATITE



QUARTZ

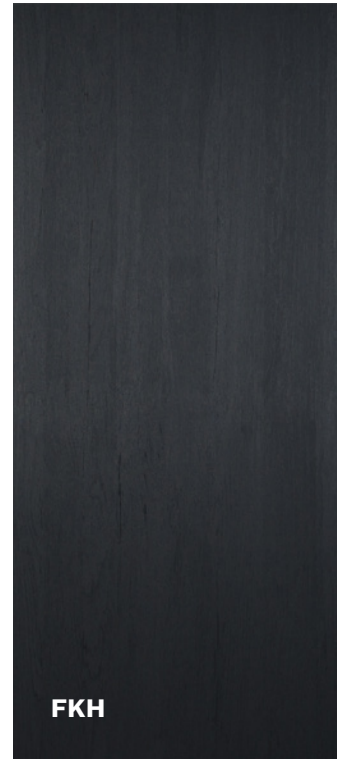

ENJOY DOORS

NORTH WALNUT



MOUNTAIN OAK



GREY OAK



MOULDING AND FRAMES OF ELITE PACKAGE

WENGE

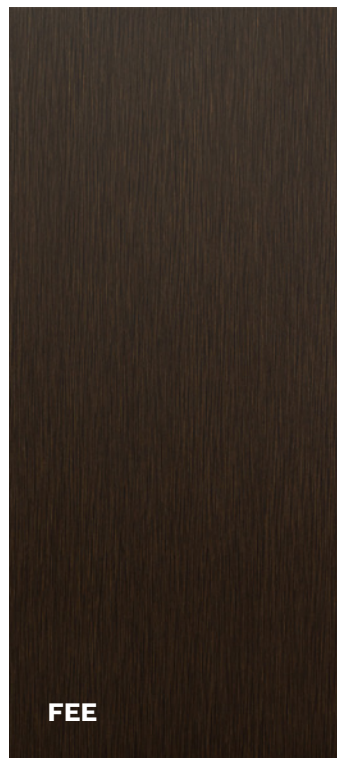

WENGE

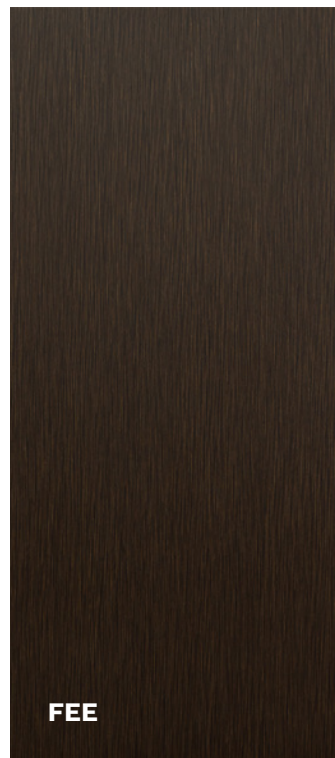

DARK BROWN

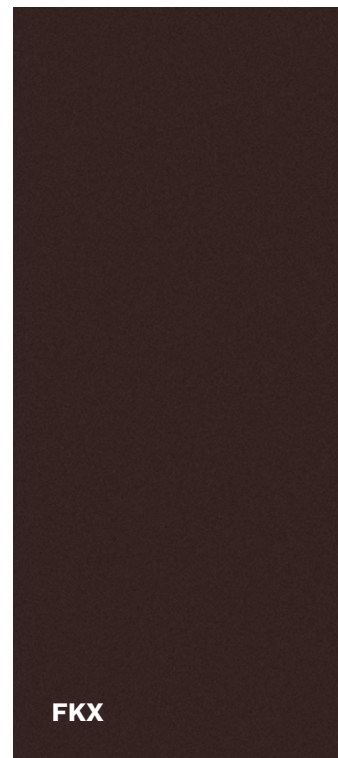

GREY



SILVER



SONOMA



DOOR LEAF DIMENSIONS

SIZE	METAL DOORS			
	A	B	C	D
80N	783	813	2025	2040
80	813	843		
90N	883	913		
90E *	926	956		
90Z *	946	976		
100E	1026	1056		

*90E – size available for Star 60 doors only;
90Z – size available for Comfort 60 and Premium 60 doors only

DOOR FRAME DIMENSIONS

COMFORT

SIZE	FD SYMMETRICAL DOOR FRAME WITHOUT SEAL						ASSEMBLY HOLE	
	J	K	L	M	N	O	X	Y
80N	764	872	-	2005	2078	-	902	2093
80	794	902	-			-	932	
90N	864	972	-			-	1002	
90Z	927	1035	-			-	1065	
100E	1007	1115	-			-	1145	

COMFORT

SIZE	FN CORNER DOOR FRAME WITHOUT SEAL						ASSEMBLY HOLE	
	J	K	L	M	N	O	X	Y
80N	764	798	872	2005	2041	2078	829	2056
80	794	828	902				859	
90N	864	898	972				929	
90Z	927	961	1035				992	
100E	1007	1041	1115				1072	

DOOR OPENING DIRECTIONS

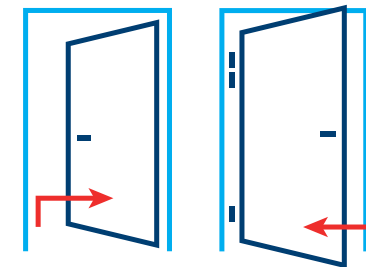

LEFT

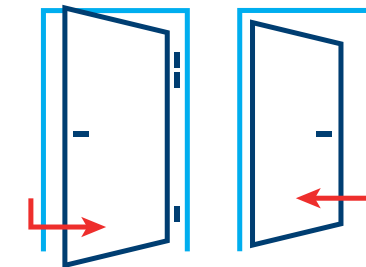

RIGHT

TECHNICAL DRAWINGS

FD

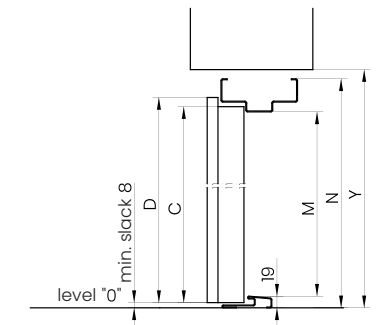
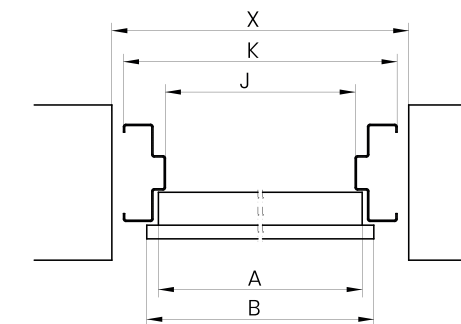
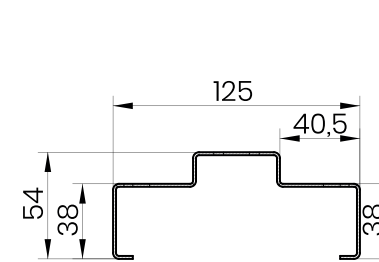

FN

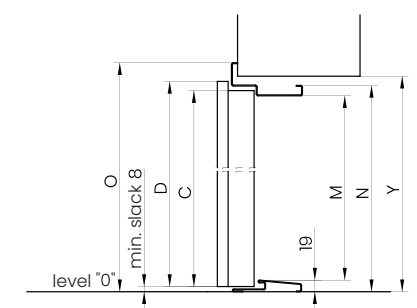
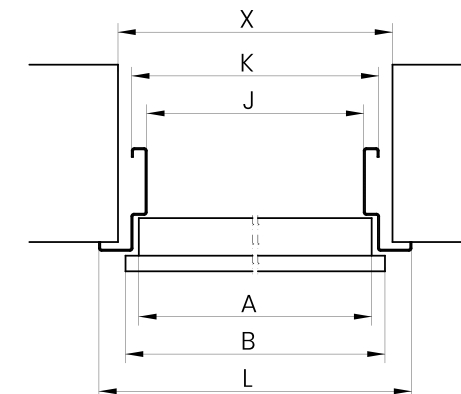
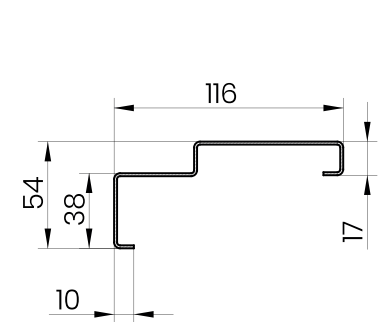

DOOR AND FRAME DIMENSIONS

ADDITIONAL INFORMATION FOR ASSEMBLY

DOOR LEAF DIMENSIONS

SIZE	METAL DOORS				PANEL DOORS			
	A	B	C	D	A	B	C	D
80N	783	813	2025	2040	786	816	2025	2040
80	813	843			816	846		
90N	883	913			885	915		
90E *	926	956			929	959		
90Z *	946	976			949	979		
100E	1026	1056			1029	1059		

*90E – size available for Star 60 doors only; 90Z – size available for Comfort 60 and Premium 60 doors only

DOOR FRAME DIMENSIONS

COMFORT, PREMIUM, STAR

SIZE	FA ASYMMETRICAL DOOR FRAME WITH SEAL									ASSEMBLY HOLE		
	J	J**	K	K**	L	L**	M	N	O	X	X**	Y
80N	765	761	872	868	-	-	2005,5	2078	-	902	898	2093
80	795	791	902	898	-	-				932	928	
90N	865	861	972	968	-	-				1002	998	
90E *	908	-	1015	-	-	-				1045	-	
90Z *	928	924	1035	1031	-	-				1065	1061	
100E	1008	1004	1115	1111	-	-				1145	1141	

*90E – size available for Star 60 doors only; 90Z – size available for Comfort 60 and Premium 60 doors only
**for metal doors in EI30 design

COMFORT, PREMIUM, STAR

SIZE	FT CORNER DOOR FRAME WITH SEAL									ASSEMBLY HOLE		
	J	J**	K	K**	L	L**	M	N	O	X	X**	Y
80N	765	761	799	795	872	868	2005,5	2041,5	2078	829/847 ¹	825/843 ¹	2057
80	795	791	829	825	902	898				859/877 ¹	855/873 ¹	
90N	865	861	899	895	972	968				929/947 ¹	925/943 ¹	
90E *	908	-	942	-	1015	-				972/990 ¹	-	
90Z *	928	924	962	958	1035	1031				992/1010 ¹	988/1006 ¹	
100E	1008	1004	1042	1038	1115	1111				1072/1090 ¹	1068/1086 ¹	

*90E – size available for Star 60 doors only; 90Z – size available for Comfort 60 and Premium 60 doors only
** for metal doors EI30

¹ - dimension of raw installation hole including clearance for deadbolts and fixed bolts caps

DOOR AND FRAME DIMENSIONS

ADDITIONAL INFORMATION FOR ASSEMBLY

DOOR OPENING DIRECTIONS

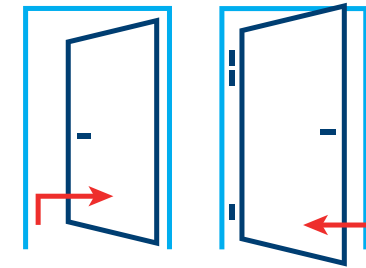

LEFT

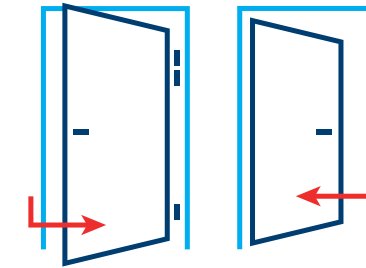

RIGHT

TECHNICAL DRAWINGS

FA

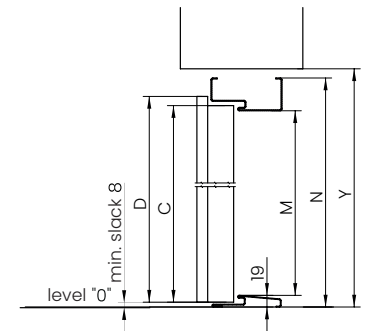
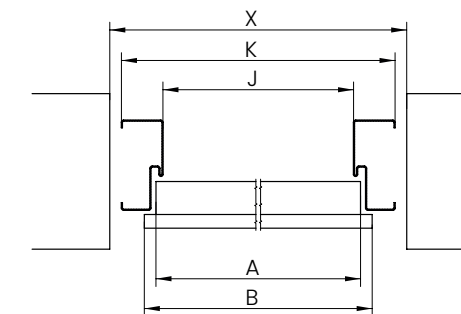
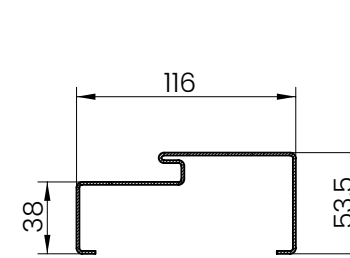

FT

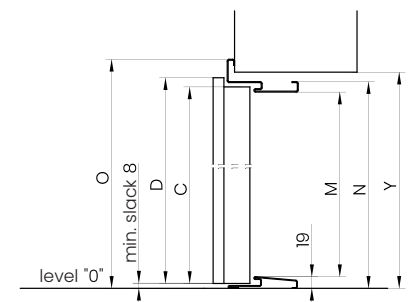
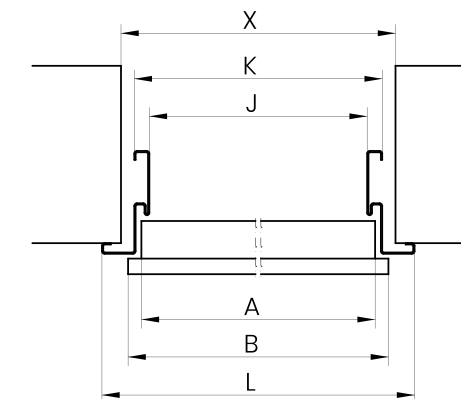
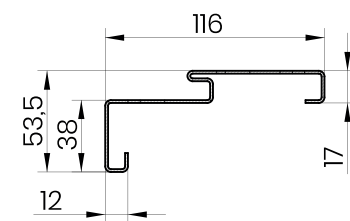

DOOR AND FRAME DIMENSIONS

ADDITIONAL INFORMATION FOR ASSEMBLY

DOOR LEAF DIMENSIONS

SIZE	METAL DOORS				PANEL DOORS			
	A	B	C	D	A	B	C	D
80N	783	813	2025	2040	786	816	2025	2040
80	813	843			816	846		
90N	883	913			885	915		
90E *	926	956			929	959		
90Z *	946	976			949	979		
100E	1026	1056			1029	1059		

*90E – size available for Star 60 doors only; 90Z – size available for Comfort 60 and Premium 60 doors only

DOOR FRAME DIMENSIONS

COMFORT, PREMIUM, STAR

SIZE	FA ASYMMETRICAL PORTAL DOOR FRAME WITH SEAL										ASSEMBLY HOLE		
	J	J**	K	K**	L	L**	M	N	O	U	X	X**	Y
80N	765	761	872	868	-	-	2005,5	2078	-	95	902	898	2093
80	795	791	902	898	-	-					932	928	
90N	865	861	972	968	-	-					1002	998	
90E *	908	-	1015	-	-	-					1045	-	
90Z *	928	924	1035	1031	-	-					1065	1061	
100E	1008	1004	1115	1111	-	-					1145	1141	

*90E – size available for Star 60 doors only; 90Z – size available for Comfort 60 and Premium 60 doors only
**For metal doors in EI30 design

COMFORT, PREMIUM, STAR

SIZE	FT CORNER PORTAL DOOR FRAME WITH SEAL									ASSEMBLY HOLE		
	J	J**	K	K**	L	L**	M	N	O	X	X**	Y
80N	765	761	799	795	872	868	2005,5	2041,5	2078	829/847 ¹	825/843 ¹	2057
80	795	791	829	825	902	898				859/877 ¹	855/873 ¹	
90N	865	861	899	895	972	968				929/947 ¹	925/943 ¹	
90E *	908	-	942	-	1015	-				972/990 ¹	-	
90Z *	928	924	962	958	1035	1031				992/1010 ¹	988/1006 ¹	
100E	1008	1004	1042	1038	1115	1111				1072/1090 ¹	1068/1086 ¹	

* 90E – size available for Star 60 doors only; 90Z – size available for Comfort 60 and Premium 60 doors only
** for metal doors EI30
1 – dimension of raw installation hole including clearance for deadbolts and fixed bolts caps

DOOR AND FRAME DIMENSIONS

ADDITIONAL INFORMATION FOR ASSEMBLY

DOOR OPENING DIRECTIONS

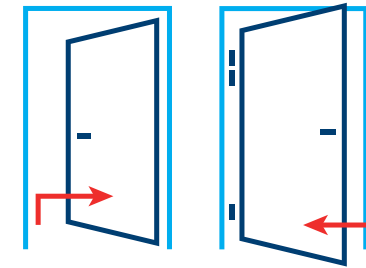

LEFT

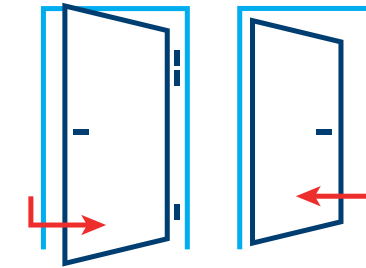

RIGHT

TECHNICAL DRAWINGS

FA ASYMMETRICAL PORTAL DOOR FRAME WITH SEAL

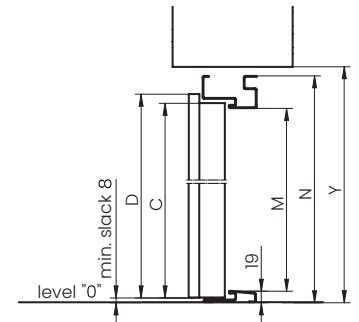
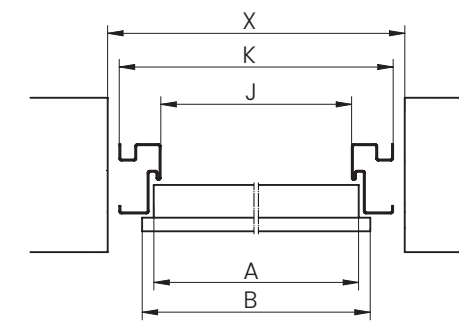
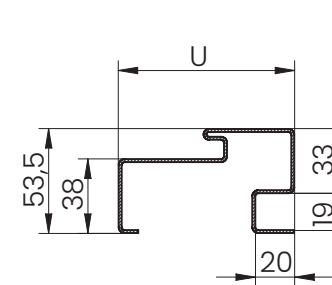

FT CORNER PORTAL DOOR FRAME WITH SEAL

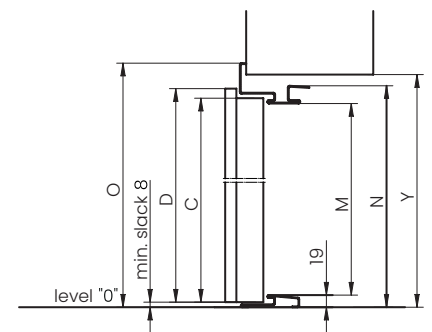
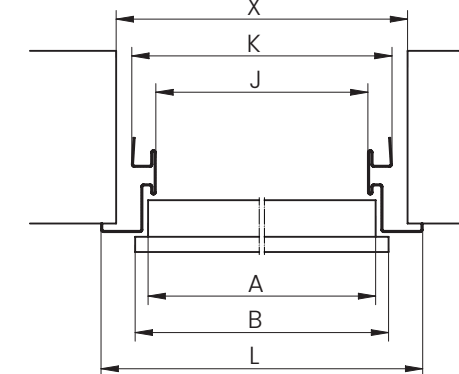
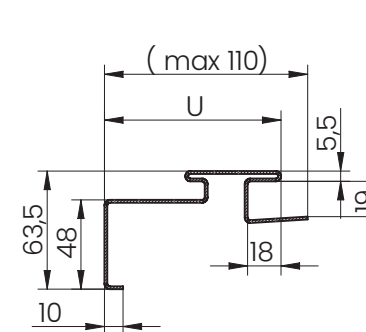

ENJOY DOOR LEAF DIMENSIONS

SIZE	LEAF DIMENSIONS			
	A	B	C	D
80	816	844	2025	2040
90	916	944		

ENJOY DOOR FRAME DIMENSIONS

SIZE	FA ASYMMETRICAL WOODEN DOOR FRAME WITH SEAL				ASSEMBLY HOLE	
	J	K	M	N	X	Y
80	800	887	2005	2070	907	2085
90	900	987			1007	

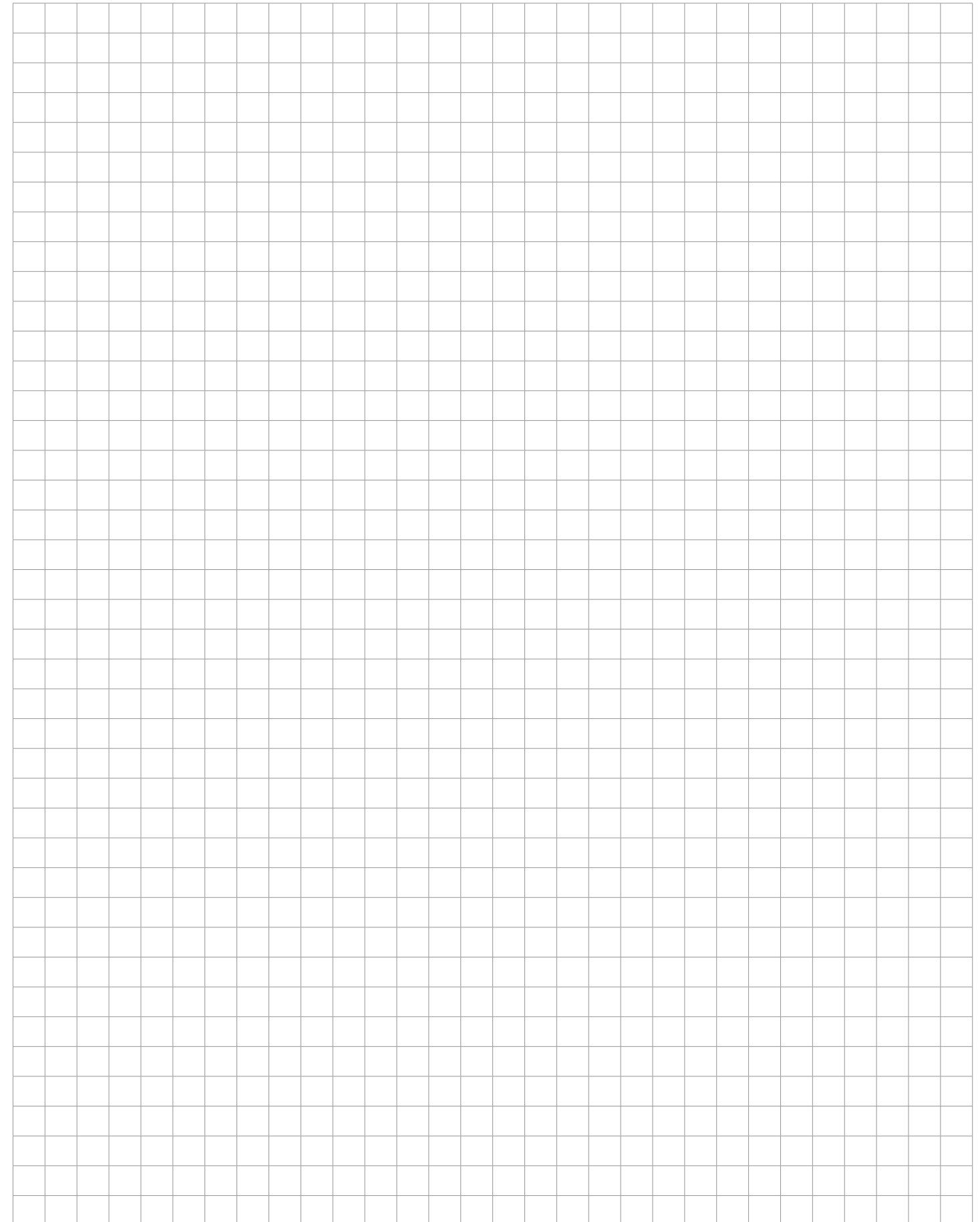
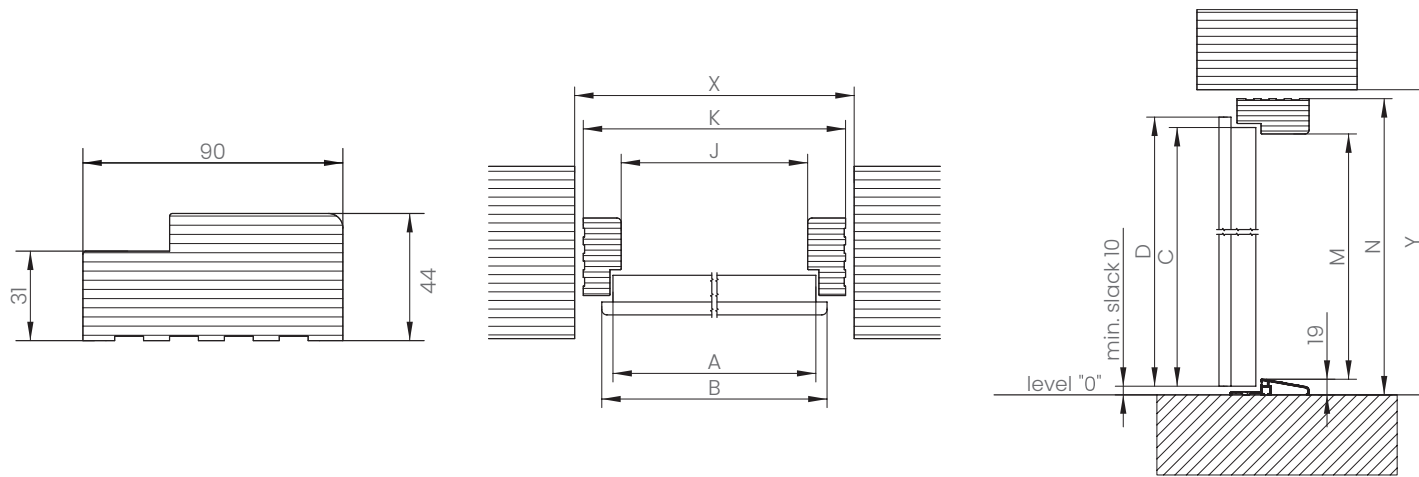

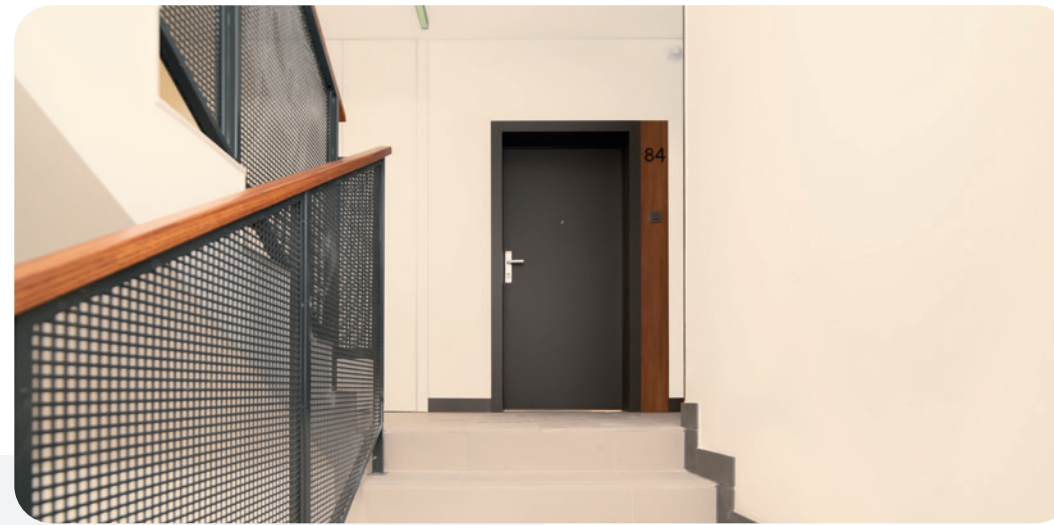



Gerda Sp. z o.o.

Sokołów, ul. Sokołowska 49

05-806 Komorów

Poland

Phone: (+48) 22 329 10 30

e-mail: export@gerda.pl

www.gerda.pl

This product catalogue does not constitute an offer within the meaning of law and is for information purposes only.

Gerda, aiming to improve the quality of its products and services, reserves (without prior notice) the right to make changes to products which, due to the process of preparing printed materials, may not be included in this material.

Despite efforts to carefully control the information presented, factual or printing errors may occur.

The colours presented in the catalogue may differ from the original due to a different colour reproduction technique in the printing process.

The owner of copyrights of this catalogue and Gerda logos and graphic elements is Gerda Sp. z o.o.

It is forbidden to copy and distribute any content and materials without the prior consent of Gerda Sp. z o.o.