

GERDA®

PREMIUM DOOR MANUFACTURER



APARTMENT DOORS

STAR | PREMIUM | COMFORT

LIST OF CONTENTS

GERDA®

YOUR NEW DOOR - STEP BY STEP

COMPANY INFORMATION **3**

NOVELTIES IN THE OFFER **4**

ELITE PACK (DOOR PANEL CONSTRUCTION) **5**

COMFORT AND SAFETY **6**

GERDA TEDEE **7**

GERDA STAR 60 DOORS **10-15**

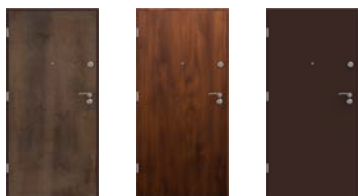

GERDA PREMIUM 60 DOORS **16-21**



GERDA COMFORT 60 DOORS **22-27**

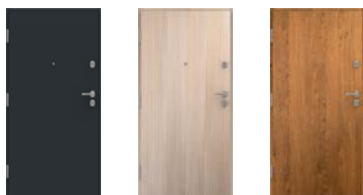

MASKING BANDS **28**

DOOR AND FRAME DIMENSIONS **30**

ACCESSORIES AND FIXTURES **36**

DOOR COLOURING **40**

INSPIRATIONS **42**

PRODUCTS WITH A BRAND QUALITY GUARANTEE



GERDA[®]

We have created products that have already become iconic and millions of Poles have welcomed them in their homes.

GERDA is associated with safety, reliability and comfort. We do our best to continuously develop and improve our products.

A POLISH MANUFACTURER WITH TRADITION AND EXPERIENCE



30 YEARS GERDA[®]

GERDA is a Polish manufacturer of doors, locks, fittings and sectional garage doors. The company has been appreciated for over 30 years by partners, assemblers and users. We design and create with passion! Our customers receive modern, durable -and reliable products. We are worthy of trust!

PRODUCTS KNOWN ACROSS POLAND

DOORS



FITTINGS



GATES



NOVELTIES IN THE OFFER

GERDA®

OUR STANDARD PROVIDES YOU WITH MORE

WITH OUR CUSTOMERS IN MIND, THE TEAM OF ENGINEERS AND CONSTRUCTORS IS CONSTANTLY WORKING ON MODIFICATIONS THAT IMPROVE SAFETY AND COMFORT OF USE

ADJUSTABLE 3D HINGE



The new hinges with 3-way adjustments are now standard in the COMFORT 60 and PREMIUM 60 lines. This solution provides a very convenient and quick way of adjusting the door, without having to dismantle the leaf from the frame.

ADJUSTABLE LATCH CATCH OF THE HANDLE



An adjustable latch catch is offered in all the doors from the apartment doors offer. It enables the smooth adjustment of the leaf pressure to the gaskets. Thanks to this solution, adjusting the pressure is always easy (reduce or increase the pressure on the gasket).

IMPROVED ACOUSTIC PACK

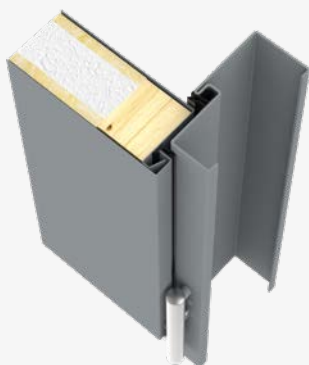

The use of innovative gaskets in leaves and FRAMES that form one plane provides very good acoustic properties. Noise from the staircase does not penetrate the apartment.



PREMIUM LOCKS AS STANDARD



All apartment doors have been equipped with PREMIUM locks, in which deadbolts with a safe design have been reinforced by 30%. Additionally, market-unique reinforcement of internal deadbolts made of hardened steel has been applied.



LARGE SELECTION OF ESCUTCHEONS AND HANDLES

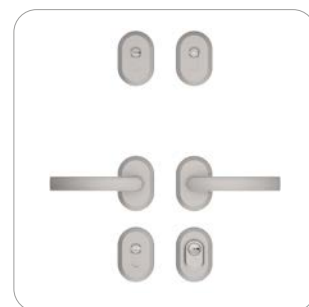
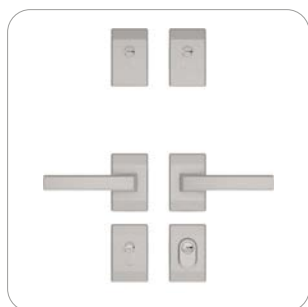

The possibility to customise the appearance of the door thanks to a wide range of oval, oblong and split ESCUTCHEONS in the COMFORT and PREMIUM series.

PANEL-TYPE DOORS HAVE A MULTI-LAYER LEAF WITH A STEEL BOX BODY AND REPLACEABLE CLADDINGS ON BOTH SIDES

PANEL STRUCTURE

Panel doors will be perfect as apartment front doors and their appearance can be customised. The panels are mounted to the steel body making the door sturdier and bracing the leaf. Upon the customer's request, the panels can vary in colour on the inside and the outside. The well-thought-out method of mounting the panels to the body enables easy disassembly and replacement in case of damage or rearrangement, without the need for a costly replacement of the entire door.



**DISMANTLE
THE EXISTING PANEL**



**CHOOSE A COLOUR
FROM THE ELITE PACK**



**ENJOY THE NEW LOOK
OF YOUR DOOR**

COMFORT AND SAFETY

GERDA®

WHAT YOU SHOULD KNOW ABOUT GERDA DOORS



ANTI-BURGLARY

All our doors are structurally reinforced, with solutions that make it difficult to force them open. They are also equipped with an anti-burglary lock cylinder, which is what GERDA is renowned for. However, for the antiburglary parameters to be confirmed, the door must pass specialised tests and trials for RC2, RC3 and RC4 classes, concluded with the issuance of an appropriate certificate. GERDA doors possess such certificates and approvals. They can be downloaded at any time from www.gerda.pl. The doors offered by GERDA can be bought in class RC2, RC3 and RC4 (detailed explanations at the bottom of the page).



EXCELLENT ACOUSTIC COMFORT

When buying a door, acoustic comfort must be taken into consideration in order to ensure that as little sound as possible comes into our apartment. The sound reduction index (R_w) is expressed in dB (decibels). The higher the value of the index, the better the sound reduction of the door. Our apartment doors have a very good sound reduction index (from 33 to even 47 dB). If there is 80 dB of sound coming from the outside (this corresponds to loud music) it will be reduced from 33-47 dB to even 33 dB, which is the level of a silent conversation.





FIRE PROTECTION





In our offer of GERDA apartment doors, you can also choose a fire protection pack (available in the PREMIUM 60 series). Fire-resistant doors are designed to stop the spread of fire and smoke. Products with the aforementioned properties are marked with the symbol EI (fire integrity criterion - E and fireproof insulation - I). GERDA offers doors with EI30, EI45 and EI60 parameters which mean the protection lasts for 30 and 60 minutes respectively. The owner of such a door has a guarantee that the flames will not pass through the door for the indicated time and that the door temperature will not cause the fire to spread. The smoke-proofing class is S200.

ANTI-BURGLARY CLASSES

RC2 CLASS

-  PLIERS
-  WEDGE
-  HAMMER

RC3 CLASS

-  STEEL CROWBAR
-  WEDGE
-  HAMMER
-  MECHANICAL DRILL

RC4 CLASS

-  HEAVY HAMMER
-  AXE
-  GOUGE
-  CHISEL
-  DRILL

TURN YOUR SMARTPHONE INTO A SMART DOOR LOCK



OPEN THE DOOR WITH A SMARTPHONE

Open and close the door and check the lock status from wherever you are. Thanks to the automatic opening function you don't have to take your smartphone out of your pocket or purse. The lock will detect it and let you enter. You can use the automatic lock function similarly.

EFFICIENT BATTERY

Gerda engineers in cooperation with the Research Institute of South Korea have developed a very efficient small dedicated battery. The battery supplies the mechanism with power for six months. However, when it needs charging, the lock will let you know, the battery takes one night to charge.

SAFETY GUARANTEE

The mechanism driving the lock is an innovative and patented design developed by Gerda engineers. The software was created by IoT experts from Tedee. With the intuitive application, you can see who closed or opened the door and when, as well as assign virtual keys remotely.

SET

TEDEE LOCK + TEDEE BRIDGE + CLASS 6 LOCK INSERT



CLASS 6 LOCK CYLINDER INCLUDES:

- ✓ ANTIBURGLAR LOCK CYLINDER. NEW LOCK CYLINDER DESIGN PROTECTING AGAINST BUMPING, AN EFFECTIVE SOLUTION PROTECTING AGAINST DRILLING THE DOOR OPEN.



INSTALL TEDEE'S LOCK

- ✓ SLIDE THE LOCK INTO THE GERDA LOCK CYLINDER, ADJUST THE POSITION OF THE LOCK AND FASTEN WITH ONE SCREW. THIS OPERATION WILL NOT TAKE MORE THAN TWO MINUTES. CHECK IF THE DEADBOLTS MOVE WHEN YOU TURN THE KNOB.



INSTALL THE APP ON YOUR SMARTPHONE

- ✓ DOWNLOAD THE TEDEE APPLICATION FROM THE APPLE STORE OR GOOGLE PLAY. REGISTER AND TURN ON BLUETOOTH, LOCATION SERVICES AND THE INTERNET. ADD THE LOCK AND ENTER THE ACTIVATION CODE.



CONNECT BRIDGE

- ✓ FIND A FREE SOCKET CLOSEST TO THE LOCK AND CONNECT THE BRIDGE TO IT. IT WILL ALLOW YOU TO HAVE FULL CONTROL OVER YOUR LOCK VIA THE INTERNET, NO MATTER WHERE YOU ARE.



STAR 60







STAR 60







PREMIUM 60

STAR 60

-  RC4 ANTI-BURGLARY CLASS
-  LEAF THICKNESS 60 / 70 (mm)
-  SOUND REDUCTION INDEX 43 / 47 (dB)
-  ELITE PANEL STRUCTURE

PREMIUM 60

-  BURGLARY CLASS RC2 / RC3 / RC4
-  LEAF THICKNESS 60 / 70 (mm)
-  SOUND REDUCTION INDEX 42 (dB)
-  FIRE RESISTANCE CLASS EI30/EI45/EI60
-  ELITE PANEL STRUCTURE

WELCOME TO THE SAFE AND QUIET WORLD OF GERDA DOORS



PREMIUM 60



COMFORT 60



COMFORT 60

COMFORT 60



ANTI-BURGLARY CLASS RC2/RC3



LEAF THICKNESS 60 (mm)



SOUND REDUCTION INDEX 33 (dB)

GERDA STAR 60

APARTMENT DOORS



**TOP
ANTI-BURGLARY
CLASS**



**EXCELLENT
SOUNDPROOFING**





GERDA STAR 60

GERDA®

EXCELLENT ACOUSTIC COMFORT AND THE HIGHEST LEVEL OF SAFETY

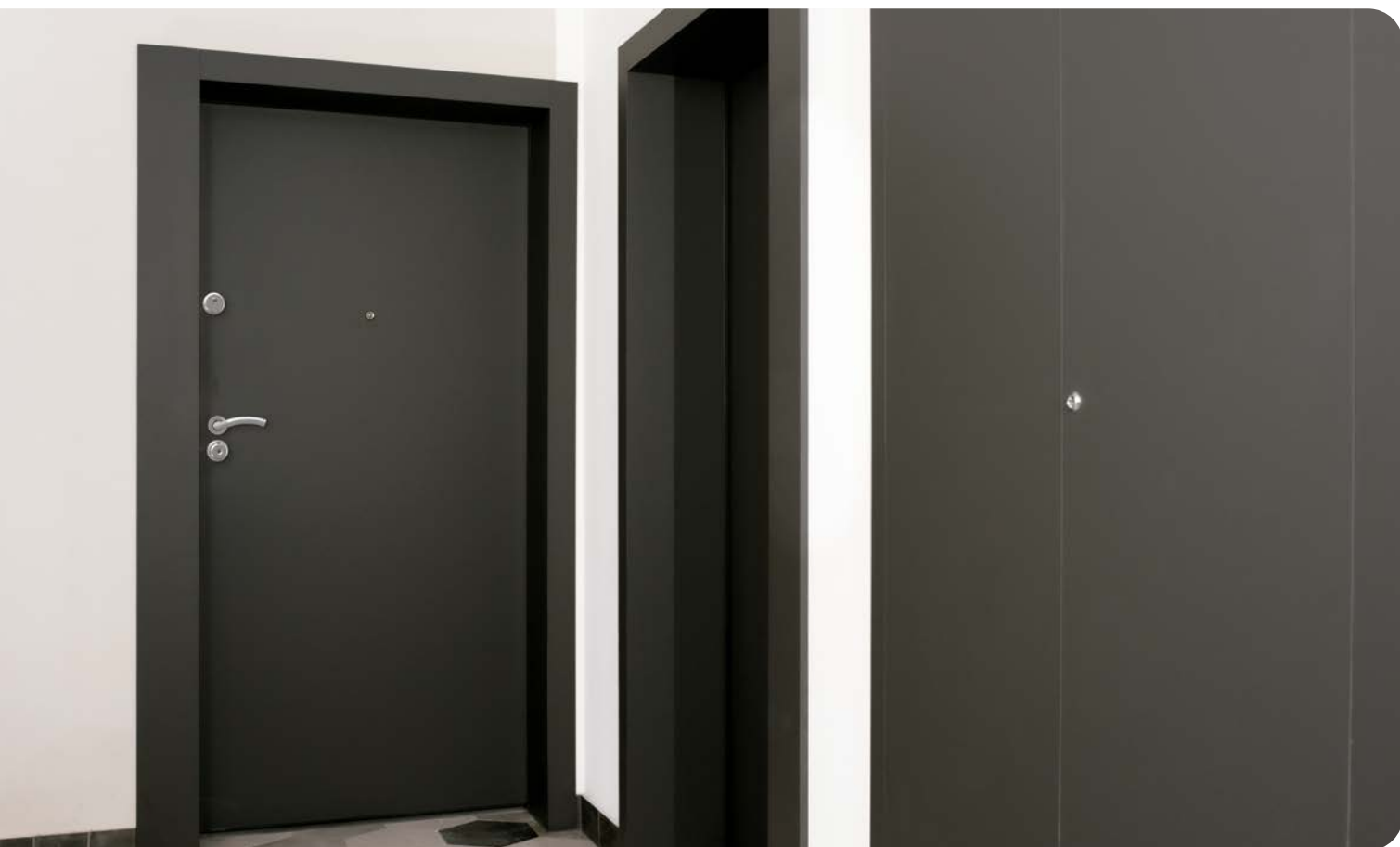

CHARACTERISTICS

| | | |
|--|------------------------------------|---|
|  | ANTI-BURGLARY CLASS | RC4 |
|  | LEAF THICKNESS / WITH ELITE PACK | 60 / 70* (mm) |
|  | SOUND REDUCTION INDEX / ELITE PACK | 43 / 47* (dB) |
|  | FILLING | POLYURETHANE FOAM FILLING + SOUNDPROOFING PACK |
|  | DOOR DIMENSIONS | 80N, 80, 90N, 90E, 100E* |

***SURCHARGE**

GERDA® STAR 60

EXCELLENT ACOUSTIC COMFORT AND THE HIGHEST LEVEL OF SAFETY



UNIQUE TUBULAR KEY

Patented RIM6000 lock cylinder with a tubular key with over 4 billion code combinations.

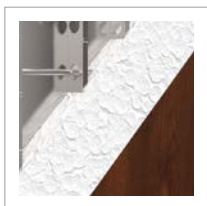

FILLING

HCFC-free polyurethane foam with a soundproofing plate providing excellent acoustic performance.



LATTICE

A lattice with thickened steel channel bars and hardened rods in the steel body of the door leaf.

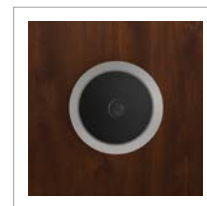

PEEPHOLE

Wide-angle peephole as standard with a very good optical performance.

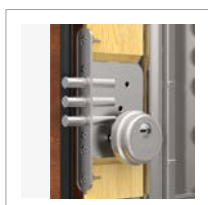

SECONDARY LOCK

Additional class 6 lock with a class 5 or class 6 cylinder.

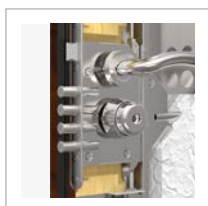

MASTER LOCK 14 LOCKING POINTS

Unique class 7 main lock with 11 mobile and thickened bolts.

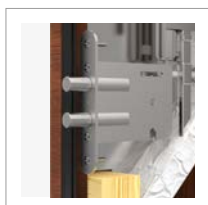

AUXILIARY LOCKS

Auxiliary upper and lower locks controlled from the main lock.

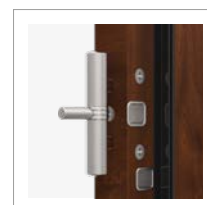
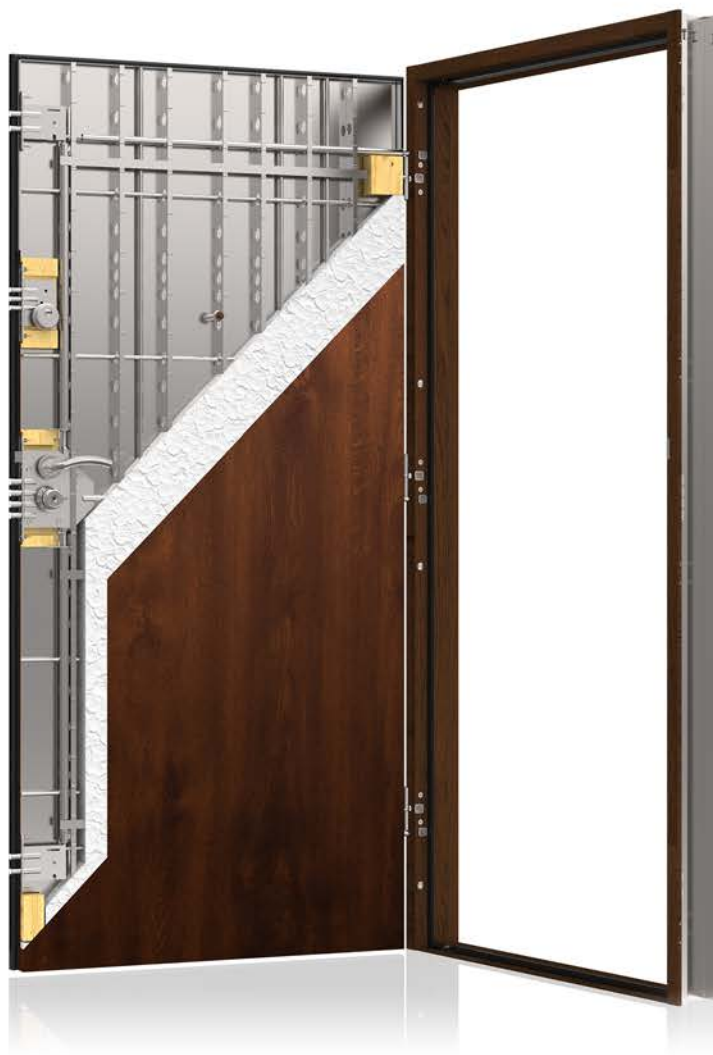

3 THREE-PIECE HINGES

Reinforced three-piece hinges with a disassembly lock and elegant casings.

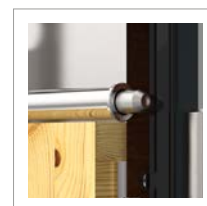

3 MOVABLE DEADBOLTS

Reinforced horizontal deadbolts on the hinge sides controlled from the main lock.



3 FIXED BOLTS

Fixed bolts in metal supports protecting against forcing the door open.

AVAILABLE FRAMES

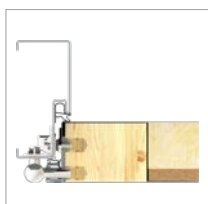

FA



FT



PORTAL

FA

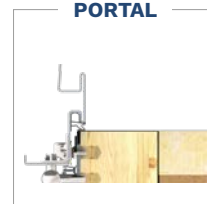

PORTAL

FT

GERDA STAR 60

GERDA®

EXCELLENT ACOUSTIC COMFORT AND THE HIGHEST LEVEL OF SAFETY

RC RC4 CLASS

dB EXCELLENT
SOUNDPROOFING

5 KEYS
AS STANDARD



RC4 STANDARD EQUIPMENT

- STAR 60 LEAF (43 dB)
- FRAME WITH GASKET
- ADJUSTABLE HINGES WITH COVERS MATCHING THE FITTINGS
- LAMINATED THRESHOLD WITH GASKET
- FITTING SET WITH LOCK CYLINDER PROTECTION
- WIDE-ANGLE PEEPHOLE
- TECHNO HANDLE
- CLASS 6 MAIN LOCK CYLINDER
- ADDITIONAL CLASS 5 LOCK CYLINDER

SURCHARGES

- NORWEGIAN THRESHOLD WOODEN WITH GASKET 19 mm / INOX THRESHOLD 19 mm/32 mm / LAMINATED/INOX THRESHOLD 32 mm
- NORWEGIAN THRESHOLD WITH RUBBER INSERT 28 mm / 35 mm*
- SIZE 100E
- ELECTRONIC PEEPHOLE 2.4" / 4.3"
- TWO-COLOUR DOORS
- DOOR SHORTENING (20, 30, 40, 50, 60, 70 mm)
- ELITE PACK (REMOVABLE PANELS) (47 dB). FLAT / WITH PATTERN
- ADDITIONAL CLASS 6 LOCK CYLINDER
- RIGID CHAIN¹

¹For frames with the DPO mounting system (doweling through the frame)

DOOR COLOURS (INCLUDING PANELS, SKIRTING BOARDS AND FRAMES OF THE ELITE PACK)

| | | | | | |
|------------------------------|--------------------------|----------------------------|--------------------------|-------------------------------|---------------------------|
| ALPINE NUT FRR | BRAZIL NUT FRB | LIGHT WALNUT FRP | GOLDEN OAK FDE | WINCHESTER FDW | LIGHT WENGE FEJ |
| WHITENED WENGE FBJ | WHITE FSB | STEEL-GREY FKZ | ANTHRACITE FKG | DARK ANTHRACITE FKF | BLACK FKC |

ADDITIONAL COLOURS OF ELITE PACK PANELS

| | | | | |
|---|--|---|--|---------------------|
| SILICON FKL FLAT DESIGN ONLY | MARBLE FKA FLAT DESIGN ONLY | HAEMATITE FDF FLAT DESIGN ONLY | QUARTZ FKH FLAT DESIGN ONLY | WENGE FEE |
|---|--|---|--|---------------------|

ADDITIONAL COLOURS OF SKIRTING BOARDS AND FRAMES OF THE ELITE PACK

| | | |
|--------------------|--------------------------|---------------------|
| GREY FKT | DARK BROWN FKX | WENGE FEE |
|--------------------|--------------------------|---------------------|

EXCELLENT ACOUSTIC COMFORT AND THE HIGHEST LEVEL OF SAFETY

ESCUTCHEONS

RIM6000 TECHNO

RC4



'RIGID CHAIN (OPTIONAL)

ESCUTCHEON COLOUR
(two-colour)

SATIN
NICKEL

GLOSSY
CHROME



FRAMES

FA



FT



TRESHHOLDS

LAMINATED

INOX

LAMINATED
/ INOX

NORWEGIAN WOODEN (bronze, light bronze, bright)



HEIGHT 19 mm
**SURCHARGE
INCLUDED**



HEIGHT 19 mm
SURCHARGE



HEIGHT 32 mm
SURCHARGE



HEIGHT 19 mm
SURCHARGE



HEIGHT 28 mm
SURCHARGE



HEIGHT 35 mm
SURCHARGE

LEAF DESIGNS WITH ELITE PACK AVAILABLE



RHH



RLF

**SURCHARGE FOR THE
TWO-SIDE DESIGN**



VA3



VA4

METAL LEAF DESIGNS AVAILABLE



TOKIO 1



TOKIO 2

**SURCHARGE FOR THE
ONE-SIDE DESIGN**

**SURCHARGE FOR THE
TWO-SIDE DESIGN**

GERDA PREMIUM

APARTMENT DOORS



**DIVERSE CLASS OF
ANTI-BURGLARY**



**VERY GOOD
SOUNDPROOFING**



**FIRE-RESISTANCE
EI30/EI45 EI60**



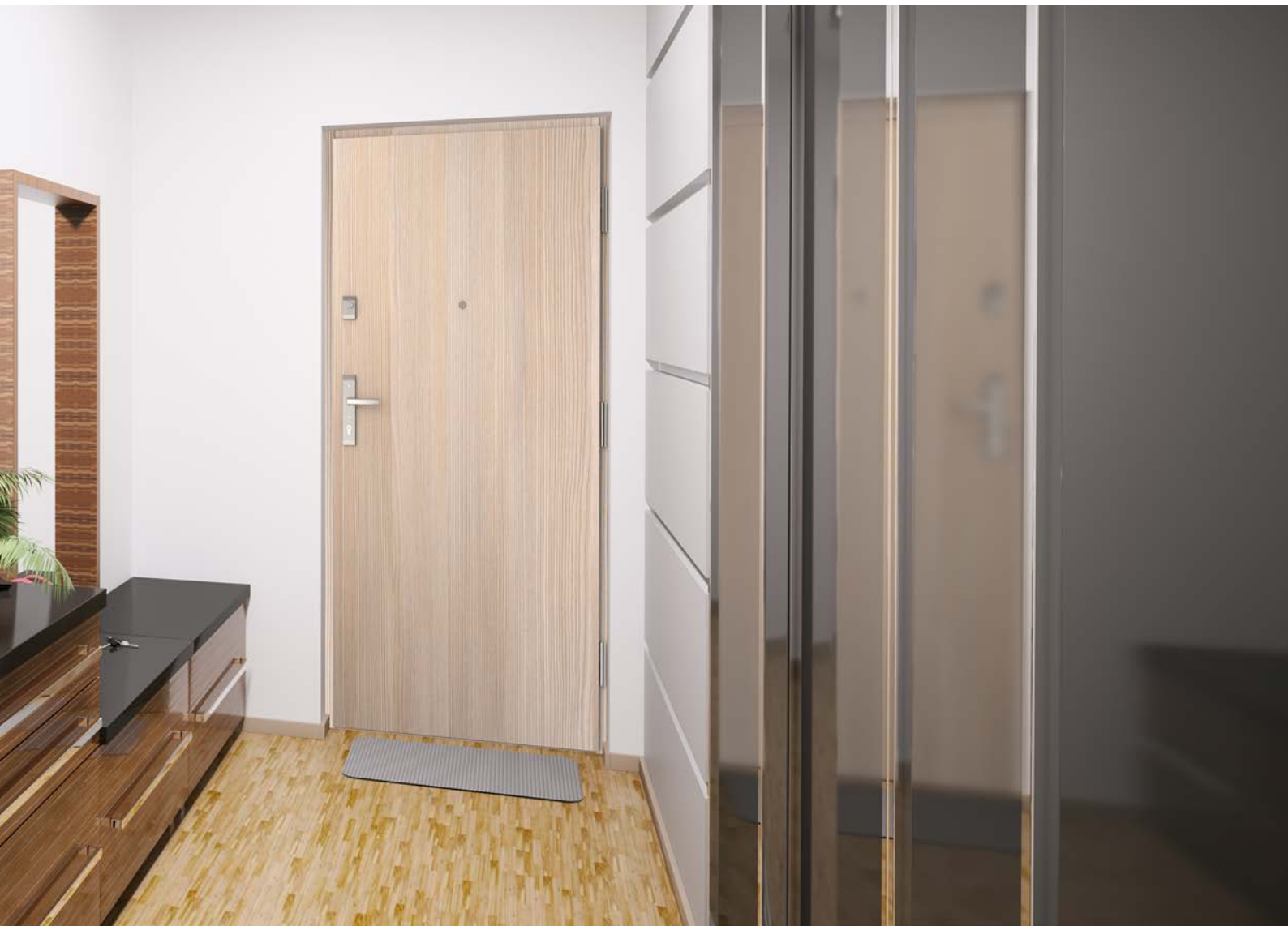







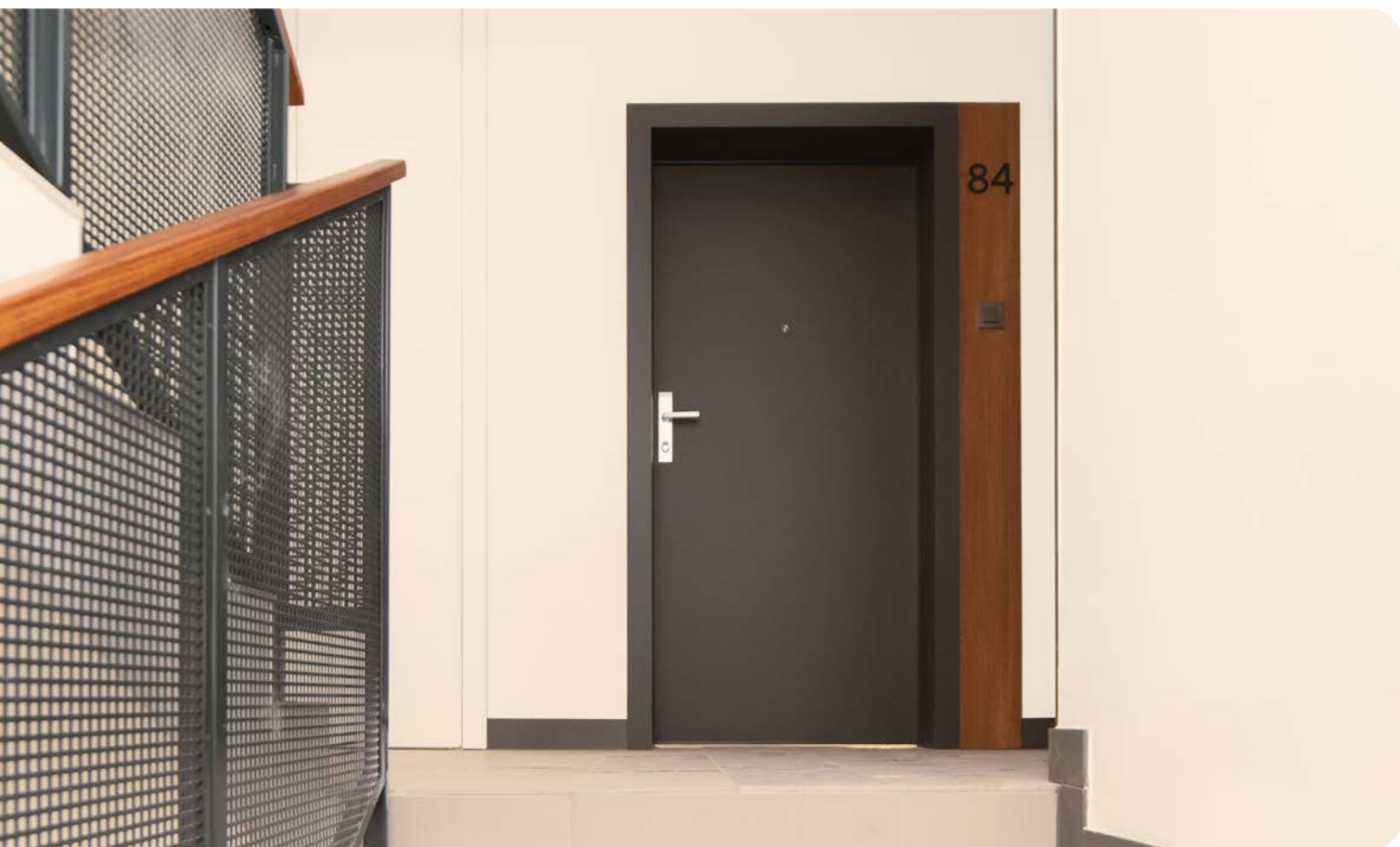

GERDA PREMIUM 60

GERDA®

HIGH LEVEL OF SAFETY AND ACOUSTIC COMFORT, ALSO IN THE FIRE-RESISTANT VERSION



CHARACTERISTICS

| | | |
|--|----------------------------------|--|
|  | ANTI-BURGLARY CLASS | RC2/RC3*/RC4* |
|  | LEAF THICKNESS / WITH ELITE PACK | 60 / 70* (mm) |
|  | SOUND REDUCTION INDEX | 42 (dB) |
|  | FILLING | SPECIAL SOUNDPROOFING FILLING PACK |
|  | FIRE RESISTANCE CLASS (FR)* | EI30^{AB}/EI45^B/EI60^A |
|  | SMOKE-PROOF CLASS | S200 (IN THE EI30^{AB}/EI45^B/EI60^A) |
|  | DOOR SIZES | 80N, 80, 90N, 90Z, 100E^C |

* SURCHARGE

A. EI30 AND EI60 AVAILABLE IN CLASS RC2 AND RC3

B. EI30 AND EI45 AVAILABLE IN CLASS RC4

C. 100E SIZE NOT AVAILABLE IN CLASS RC4 AND EI60

GERDA® PREMIUM 60

HIGH LEVEL OF SAFETY AND ACOUSTIC COMFORT, ALSO IN THE FIRE-RESISTANT VERSION



VERTICAL DEADBOLT

Anti-burglary vertical deadbolt controlled from the main lock. Available in the RC3 pack.

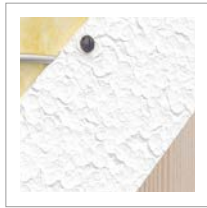

FILLING

Special filling for good acoustic comfort.



HARDENED BARS

Specially developed design of thickened and hardened steel bar protecting against burglary. Available in RC3 and RC4 class.

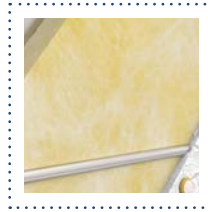

EI30D / EI45D / EI60

PREMIUM 60 doors are also available with the fire-resistant pack.



PEEPHOLE

Wide-angle peephole as standard with a very good optical performance.

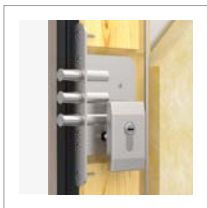

SECONDARY LOCK

Additional top lock with burglar-proof class 5 or class 6 lock cylinder.

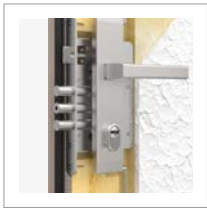

MASTER LOCK

Class 7 main lock with reinforced deadbolt construction with class 5 or class 6 anti-burglary lock cylinder



AUXILIARY LOCKS

Lower and upper auxiliary locks with a double deadbolt system controlled from the main lock. Available as a pack RC3 (1 pc) (lower) and RC4 (3 pc).



3 ADJUSTABLE 3D HINGES

Hinges (with covers) adjustable in three planes without the need of dismantling the leaf.

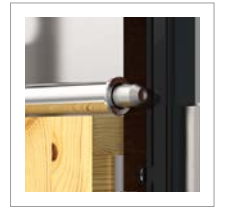

2 MOVABLE DEADBOLT

Reinforced horizontal deadbolts on the hinge sides controlled from the main lock. (Available in RC4 class).



2 FIXED BOLTS

Fixed bolts protecting against forcing the door open

| STANDARD EQUIPMENT | OPTIONAL EQUIPMENT (OPTIONAL FOR A FEE) |
|--------------------------|---|
| <input type="checkbox"/> | <input type="checkbox"/> |

AVAILABLE FRAMES

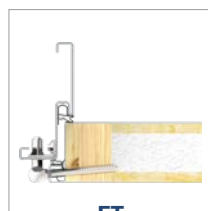

GERDA PREMIUM 60

ERDA®

SAFETY AND ACOUSTICS IN MANY ARRANGEMENTS



RC2 RC3 RC4
CLASS



VERY GOOD
SOUNDPROOFING



5 KEYS AS STANDARD
2 ASSEMBLY WRENCHES



RC2 STANDARD EQUIPMENT

PREMIUM LEAF 60 (42 dB)

FRAME WITH GASKET

ADJUSTABLE 3D HINGES WITH COVERS MATCHING THE FITTINGS

LAMINATED THRESHOLD WITH GASKET

FITTING SET WITH MAIN LOCK CYLINDER PROTECTION

WIDE-ANGLE PEEPHOLE

HANDLES (BLOCK, BERGEN OR OSLO)

CLASS 5 LOCK CYLINDERS IN A SINGLE KEY SYSTEM

SURCHARGES

RC3 / RC4 PACK

NORWEGIAN THRESHOLD WOODEN WITH GASKET 19 mm / INOX THRESHOLD 19 mm/32 mm

NORWEGIAN THRESHOLD WITH ALUMINUM INSERT 28 mm/35 mm*

SIZE 100E

ELECTRONIC PEEPHOLE 2,4" / 4,3"

TWO-COLOUR DOOR

DOOR SHORTENING (20, 30, 40⁵, 50, 60⁵, 70 mm)⁶

ELITE PACK (REPLACEABLE PANELS) FLAT / WITH PATTERN

FIRE PROTECTION PACK WITH INTEGRATED AUTOMATIC LOCK EI30 / EI45 / EI60

CLASS 6 LOCK CYLINDERS IN 1 KEY SYSTEM (STANDARD IN RC4 PACK)

RIGID CHAIN WITHOUT RC4, (DOOR FIRE-RESISTANT AND ELITE)⁴

TEDEE SET

⁴ For frames with the DPO mounting system metal door

⁵ Not applicable for fire rated doors

⁶ In RC4 package door shortening within 20, 35 mm

DOOR COLOURS (INCLUDING PANELS, SKIRTING BOARDS AND FRAMES OF THE ELITE PACK)

ALPINE NUT



BRAZIL NUT



LIGHT WALNUT



GOLDEN OAK



WINCHESTER



LIGHT WENGE



WHITENED WENGE



WHITE



STEEL-GREY



ANTHRACITE



DARK ANTHRACITE



BLACK



ADDITIONAL COLOURS OF ELITE PACK PANELS

SILICON



FLAT DESIGN ONLY

MARBLE



FLAT DESIGN ONLY

HAEMATITE



FLAT DESIGN ONLY

QUARTZ



FLAT DESIGN ONLY

WENGE



ADDITIONAL COLOURS OF SKIRTING BOARDS AND FRAMES OF THE ELITE PACK

GREY



DARK BROWN



WENGE



SAFETY AND ACOUSTICS IN MANY ARRANGEMENTS

ESCUTCHEONS

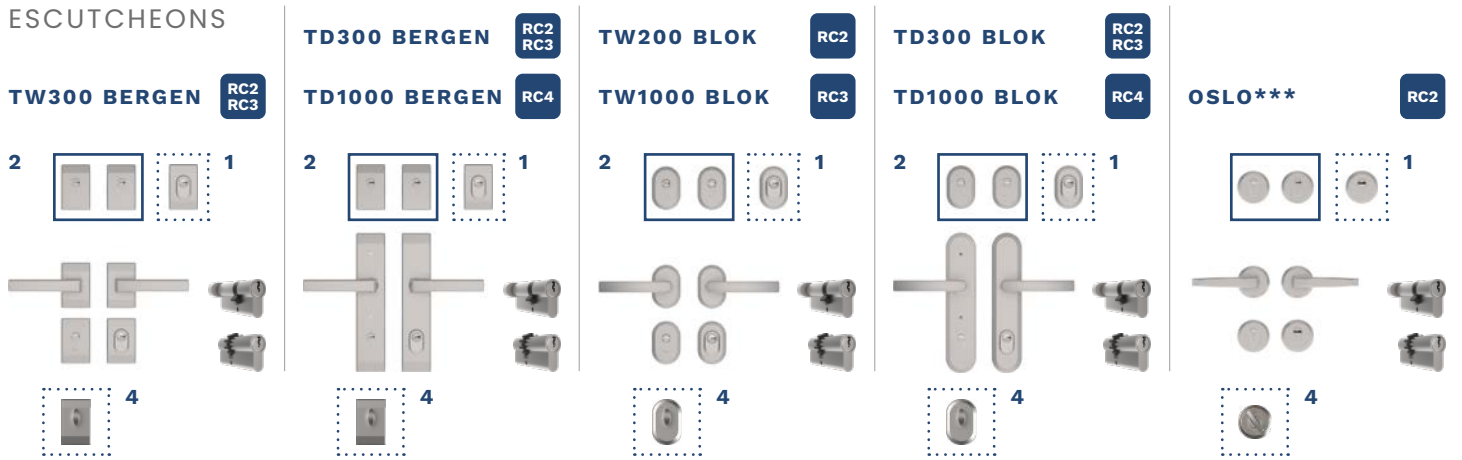

ESCUTCHEON COLOURS BERGEN AND BLOK



ESCUTCHEON COLOUR OSLO



1. PROTECTED SIGNBOARD SURCHARGES, STANDARD FOR DOOR FIRE-RESISTANT
2. NOT AVAILABLE FOR DOOR FIRE-RESISTANT EI30/EI60 (PROTECTED SIGNBOARD INCLUDED IN THE PRICE DOOR)
3. NOT AVAILABLE FOR DOOR FIRE-RESISTANT EI30/EI60
4. RIGID CHAIN (OPTIONAL)

FRAMES



LEAF DESIGNS WITH ELITE PACK AVAILABLE



SURCHARGE FOR TWO-SIDE MODEL

FOR ELITE PACK ONLY LONG ESCUTCHEONS AVAILABLE TD300 BLOK RC2, RC3 and TD1000

METAL LEAF DESIGNS AVAILABLE



SURCHARGE FOR ONE-SIDE PATTERN

SURCHARGE FOR TWO-SIDE PATTERN

TRESHHOLDS

LAMINATED



HEIGHT 19 mm
SURCHARGE INCLUDED

INOX



HEIGHT 19 mm
SURCHARGE

LAMINATED / INOX



HEIGHT 32 mm
SURCHARGE

NORWEGIAN WOODEN (bronze, light bronze, bright)

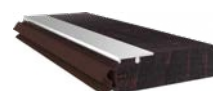

HEIGHT 19 mm
SURCHARGE



HEIGHT 28 mm
SURCHARGE



HEIGHT 35 mm
SURCHARGE

GERDA COMFORT

APARTMENT DOORS



**HIGH BURGLARY
RESISTANCE CLASS**



**GOOD
SOUND INSULATION**



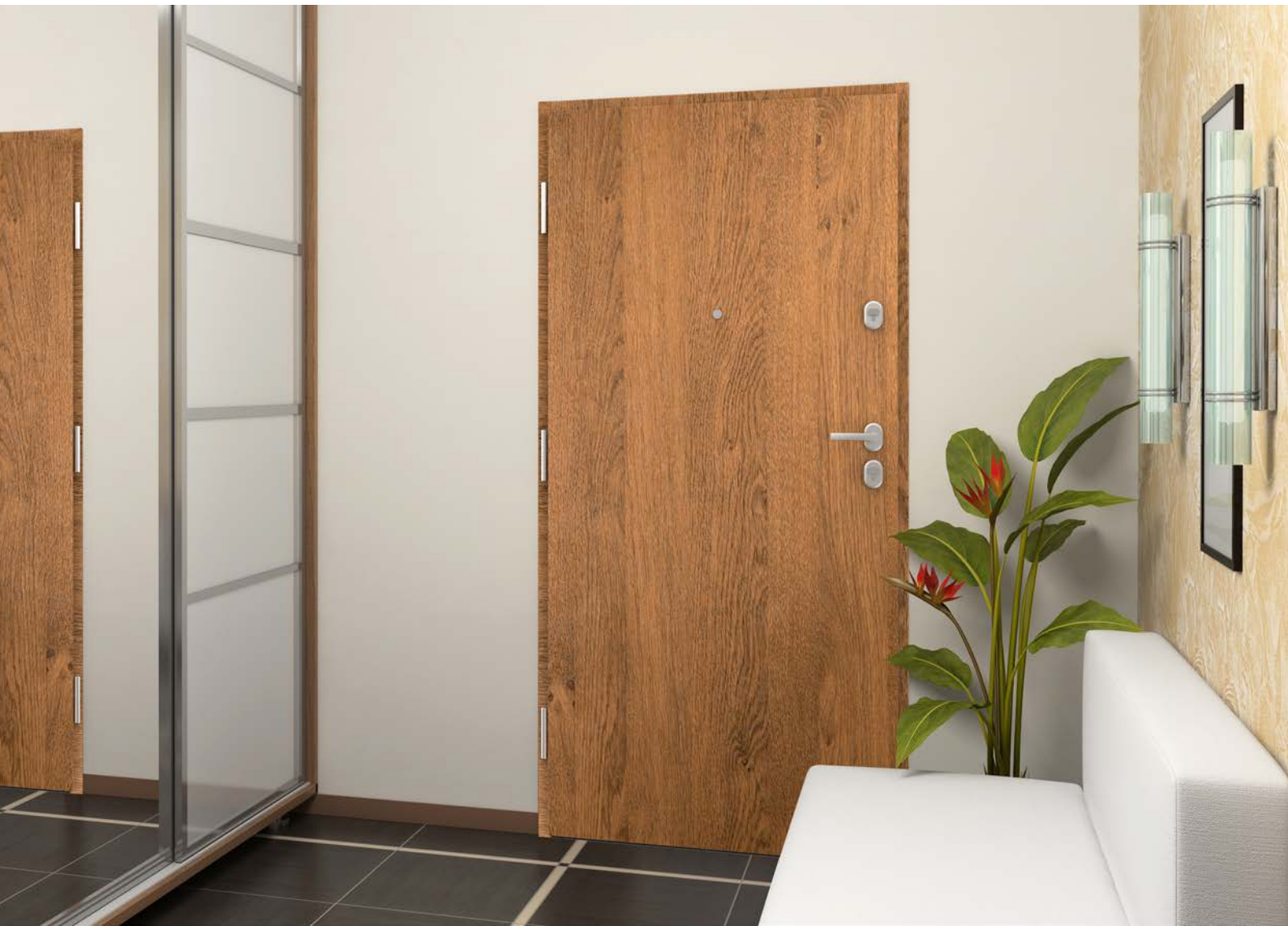





GERDA COMFORT 60

GERDA®

GREAT COMFORT AND SAFETY AT A GOOD PRICE



CHARACTERISTICS

| | | |
|--|-----------------------|----------------------------------|
|  | ANTI-BURGLARY CLASS | RC2/RC3* |
|  | LEAF THICKNESS | 60 (mm) |
|  | SOUND REDUCTION INDEX | 33 (dB) |
|  | FILLING | THE SOUNDPROOFING PACKAGE |
|  | DOOR DIMENSIONS | 80N, 80, 90N, 90Z, 100E* |

* SURCHARGE

GERDA®

COMFORT 60

GREAT COMFORT AND SAFETY AT A GOOD PRICE



VERTICAL DEADBOLT

Anti-burglary vertical bar controlled from the main lock. Available in the RC3 package.



FILLING

Special filling providing good acoustic comfort.



BAR

Specially developed design of thickened and hardened steel bar protecting against burglary. Available in RC3 class.



PEEPHOLE

Wide-angle peephole as standard with very good optical parameters.

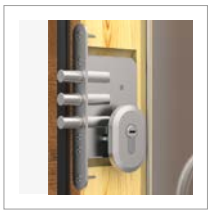

SECONDARY LOCK

Additional class 6 top lock with an anti-burglary class 5 or 6 lock cylinder.



MASTER LOCK

Class 7 main lock with thickened and reinforced deadbolt with class 5 or class 6 anti-burglar lock cylinder.



AUXILIARY LOCK

Bottom auxiliary lock with double deadbolt system controlled from the main lock. Available in RC3 pack.



3 ADJUSTABLE 3D HINGES

Hinges (with covers) adjustable in three planes without the need of dismantling the leaf.



2 FIXED BOLTS

Fixed bolts protecting against forcing the door open

| STANDARD EQUIPMENT | OPTIONAL EQUIPMENT (OPTIONAL FOR A FEE) |
|--------------------------|---|
| <input type="checkbox"/> | <input type="checkbox"/> |

AVAILABLE FRAMES

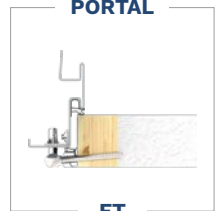
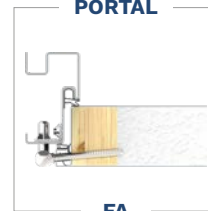

GERDA COMFORT 60

GERDA®

GREAT COMFORT AND SAFETY AT A GOOD PRICE

RC RC2 RC3
CLASS

GOOD
SOUNDPROOFING

5 KEYS AS STANDARD
2 ASSEMBLY WRENCHES



RC2 STANDARD EQUIPMENT

- COMFORT 60 LEAF (33 dB)
- GASKETLESS DOORFRAME
- ADJUSTABLE 3D HINGES WITH COVERS IN THE FRAME COLOUR
- LAMINATED THRESHOLD WITH GASKET
- FRAME SET WITH MAIN LOCK CYLINDER PROTECTION
- WIDE-ANGLE PEEPHOLE
- HANDLES (BLOCK, BERGEN OR OSLO)
- CLASS 5 LOCK CYLINDERS IN A SINGLE KEY SYSTEM

SURCHARGES

- FRAME WITH GASKET
- RC3 PACK
- NORWEGIAN THRESHOLD WOODEN 19mm / INOX THRESHOLD 19 mm/32 mm
- NORWEGIAN THRESHOLD WITH ALUMINUM INSERT 28 mm/35 mm*
- SIZE 100E
- ELECTRONIC PEEPHOLE 2,4" / 4,3"
- TWO-COLOUR DOORS
- DOOR SHORTENING (20, 30, 40, 50, 60, 70 mm)
- CLASS 6 CYLINDERS, IN 1-KEY SYSTEM
- RIGID CHAIN²
- TEDEE SET

²For frames with the DPO mounting system (metal door)

AVAILABLE METAL DOOR INSERTS



TOKIO 1



TOKIO 2

**SURCHARGE FOR ONE-SIDE
PATTERN**

**SURCHARGE FOR TWO-SIDE
PATTERN**

DOOR COLOURS

ALPINE NUT



FRR

BRAZIL NUT



FRB

LIGHT WALNUT



FRP

GOLDEN OAK



FDE

WINCHESTER



FDW

LIGHT WENGE



FEJ

WHITENED WENGE



FBJ

WHITE



FSB

STEEL-GREY



FKZ

ANTHRACITE



FKG

DARK ANTHRACITE



FKF

BLACK



FKC

GREAT COMFORT AND SAFETY AT A GOOD PRICE

ESCUTCHEON

TW300 BERGEN

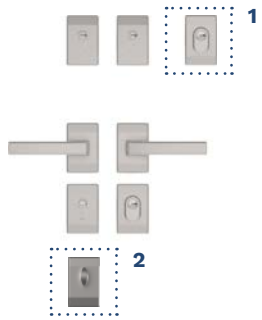

RC2
RC3

TD300 BERGEN

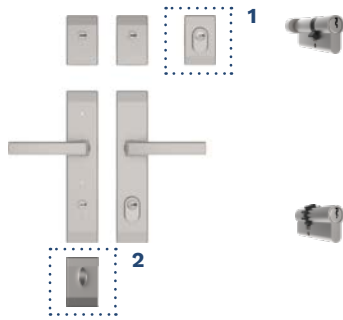

RC2
RC3

TW200 BLOK

RC2

TW1000 BLOK

RC3

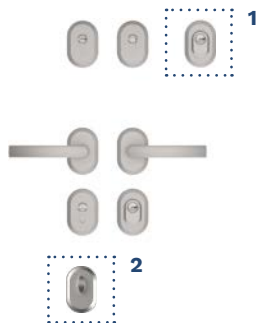

TD300 BLOK

RC2
RC3

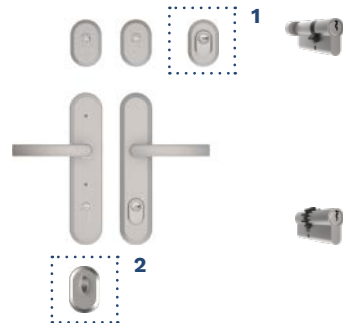

OSLO

RC2

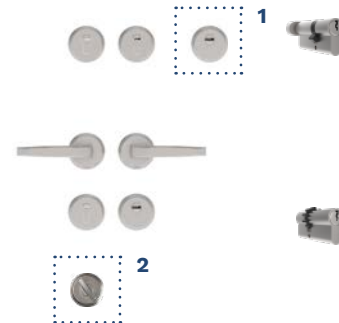

ESCUTCHEON COLOURS BERGEN AND BLOK

SILVER ANODA



PLATIN ANODA



BLACK ANODA



ESCUTCHEON COLOUR OSLO

SATIN NICKEL



*Protected escutcheon surcharge

²RIGID CHAIN (OPTIONAL)

FRAMES

FD



SURCHARGE INCLUDED

FN



SURCHARGE INCLUDED

FA



SURCHARGE

FT



SURCHARGE

TRESHHOLDS

LAMINATED



HEIGHT 19 mm
SURCHARGE INCLUDED

INOX



HEIGHT 19 mm
SURCHARGE

LAMINATED / INOX



HEIGHT 32 mm
SURCHARGE

NORWEGIAN WOODEN (bronze, light bronze, bright)



HEIGHT 19 mm
SURCHARGE



HEIGHT 28 mm
SURCHARGE



HEIGHT 35 mm
SURCHARGE

PORTAL BANDS **GERDA**®

BRING OUT THE ELEGANCE OF YOUR DOOR

A SET OF BANDS FOR ONE SIDE OF THE DOOR

MOULDING SKIRTING BOARD



MOULDINGS

This element improves the appearance of the entrance to the apartment. It makes your door stand out among regular doors. It can be applied in GERDA metal doors and with the ELITE pack in sizes 80N, 80, 90, 90Z, 100E. They are available in sets for one or both sides.



DOOR PORTALS

This is a special type of moulding, used in the specific frame opening that brings out the elegance of the door. Much like the mouldings, the door portal can be used in GERDA metal doors and with the ELITE pack in sizes 80N, 80, 90, 90Z, 100E. The decision to purchase door portals should be made when ordering doors, because they are fixed to special FRAMES available with a surcharge.



COLOUR PALLET

| GOLDEN OAK | WINCHESTER | LIGHT WALNUT | LIGHT WENGE | WENGE | WHITENED WENGE | BRAZIL NUT | ALPINE NUT | SILICON |
|------------|------------|--------------|-------------|-------|----------------|------------|------------|---------|
| FDE | FDW | FRP | FEJ | FEE | FBJ | FRB | FRR | FKL |

BRING OUT THE ELEGANCE OF YOUR DOOR



HORIZONTAL SECTION

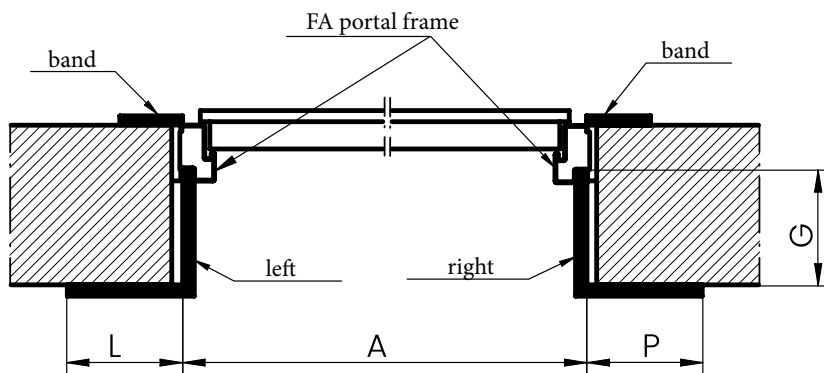

VERTICAL SECTION

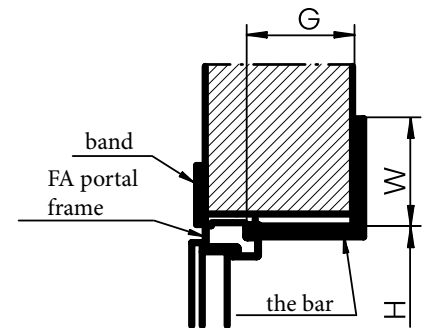

DIMENSIONS (L, P, W) W (mm)

DEPTH D (mm)

SYMMETRIC PORTAL

100

100

200

300

400

BAND SET

MOULDING SKIRTING BOARD (2400 x 80 x 12)

PORTALS WITH EQUIPMENT SUCH AS NUMBERS, SWITCHES VISIBLE ON VISUALIZATIONS AVAILABLE ON SPECIAL ORDER

| | | | | | | | | | |
|--------|-----------|--------|-------|------------|------------|----------------------|------------|-------|-----|
| MARBLE | HAEMATITE | QUARTZ | WHITE | ANTHRACITE | STEEL-GREY | DARK ANTHRACITE GREY | DARK BROWN | BLACK | |
| FKA | FDL | FKH | FSB | FKG | FKZ | FKF | FKT | FKX | FKC |

DOOR AND FRAME DIMENSIONS



ADDITIONAL INFORMATION FOR INSTALLATION

DOOR DIMENSIONS

| SIZE | METAL DOORS | | | | PANEL DOORS | | | |
|--------------|-------------|------|------|------|-------------|------|------|------|
| | A | B | C | D | A | B | C | D |
| 80N | 783 | 813 | 2025 | 2040 | 786 | 816 | 2025 | 2040 |
| 80 | 813 | 843 | | | 816 | 846 | | |
| 90N | 883 | 913 | | | 885 | 915 | | |
| 90E * | 926 | 956 | | | 929 | 959 | | |
| 90Z * | 946 | 976 | | | 949 | 979 | | |
| 100E | 1026 | 1056 | | | 1029 | 1059 | | |

*90E - size available for Star 60 doors only; 90Z - size available for Comfort 60 and Premium 60 doors only

FRAME DIMENSIONS

COMFORT

| SIZE | SYMMETRICAL FRAME WITHOUT GASKET FD | | | | | | INSTALLATION HOLE | |
|-------------|-------------------------------------|------|---|------|------|---|-------------------|------|
| | J | K | L | M | N | O | X | Y |
| 80N | 764 | 872 | - | 2005 | 2078 | - | 902 | 2093 |
| 80 | 794 | 902 | - | | | - | 932 | |
| 90N | 864 | 972 | - | | | - | 1002 | |
| 90Z | 927 | 1035 | - | | | - | 1065 | |
| 100E | 1007 | 1115 | - | | | - | 1145 | |

COMFORT

| SIZE | CORNER FRAME WITHOUT GASKET FN | | | | | | INSTALLATION HOLE | |
|-------------|--------------------------------|------|------|------|------|------|-------------------|------|
| | J | K | L | M | N | O | X | Y |
| 80N | 764 | 798 | 872 | 2005 | 2041 | 2078 | 829 | 2056 |
| 80 | 794 | 828 | 902 | | | | 859 | |
| 90N | 864 | 898 | 972 | | | | 929 | |
| 90Z | 927 | 961 | 1035 | | | | 992 | |
| 100E | 1007 | 1041 | 1115 | | | | 1072 | |

GERDA® DOOR AND FRAME DIMENSIONS

ADDITIONAL INFORMATION FOR INSTALLATION

OPENING DIRECTION FOR THE DOOR

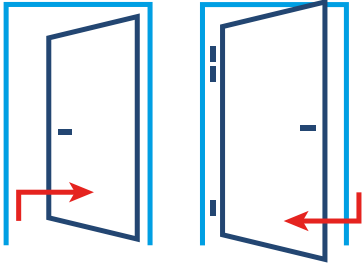

LEFT DOOR

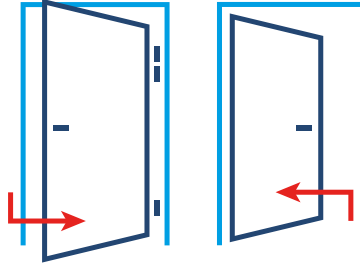

RIGHT DOOR

TECHNICAL DRAWINGS

FD

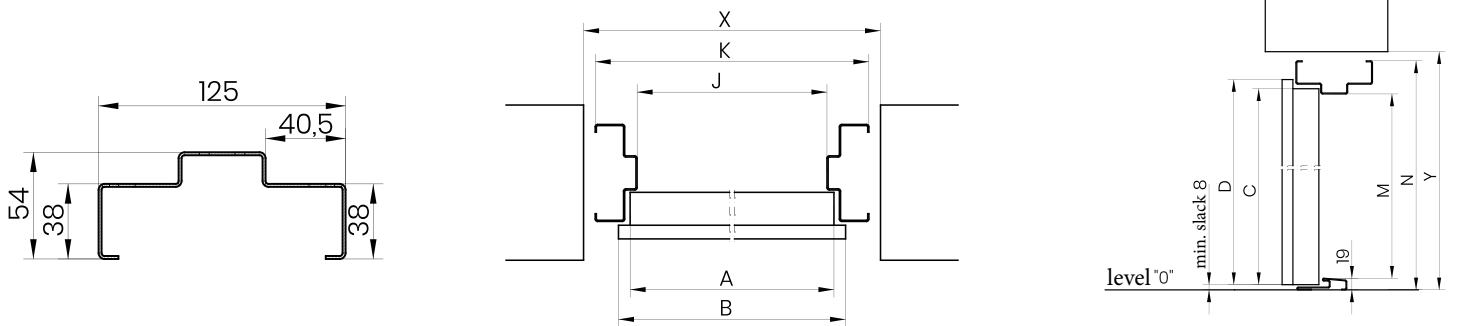

FN

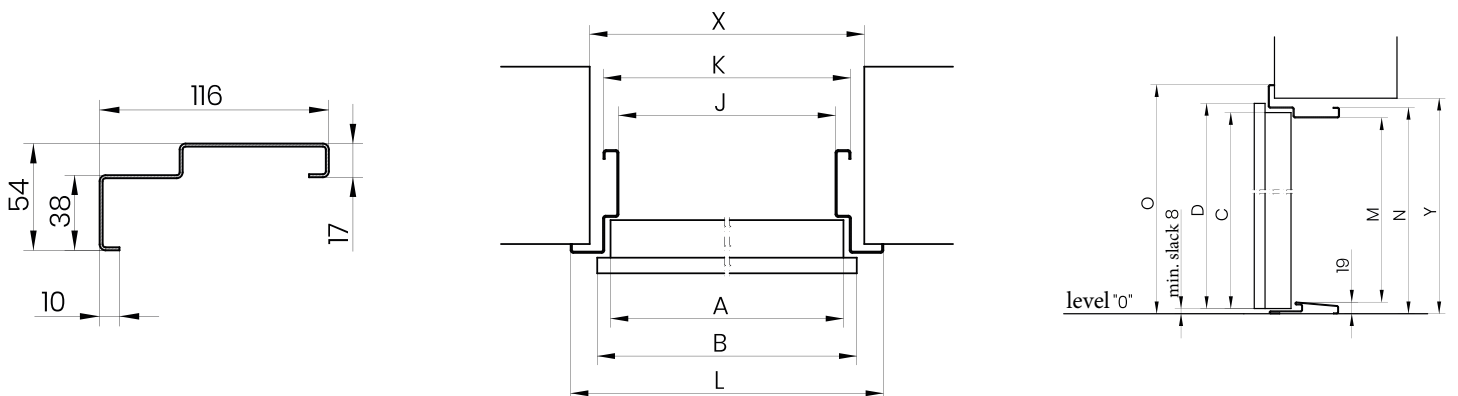

DOOR AND FRAME DIMENSIONS



ADDITIONAL INFORMATION FOR INSTALLATION

DOOR DIMENSIONS

| SIZE | METAL DOORS | | | | PANEL DOORS | | | |
|--------------|-------------|------|------|------|-------------|------|------|------|
| | A | B | C | D | A | B | C | D |
| 80N | 783 | 813 | 2025 | 2040 | 786 | 816 | 2025 | 2040 |
| 80 | 813 | 843 | | | 816 | 846 | | |
| 90N | 883 | 913 | | | 885 | 915 | | |
| 90E * | 926 | 956 | | | 929 | 959 | | |
| 90Z * | 946 | 976 | | | 949 | 979 | | |
| 100E | 1026 | 1056 | | | 1029 | 1059 | | |

*90E - size available for Star 60 doors only; 90Z - size available for Comfort 60 and Premium 60 doors only

FRAME DIMENSIONS

COMFORT, PREMIUM, STAR

| SIZE | ASYMMETRICAL FRAME WITH GASKET FA HOLE | | | | | | | | | INSTALLATION HOLE | | |
|--------------|--|------|------|------|---|-----|--------|------|---|-------------------|------|------|
| | J | J** | K | K** | L | L** | M | N | O | X | X** | Y |
| 80N | 765 | 761 | 872 | 868 | - | - | 2005,5 | 2078 | - | 902 | 898 | 2093 |
| 80 | 795 | 791 | 902 | 898 | - | - | | | | 932 | 928 | |
| 90N | 865 | 861 | 972 | 968 | - | - | | | | 1002 | 998 | |
| 90E * | 908 | - | 1015 | - | - | - | | | | 1045 | - | |
| 90Z * | 928 | 924 | 1035 | 1031 | - | - | | | | 1065 | 1061 | |
| 100E | 1008 | 1004 | 1115 | 1111 | - | - | | | | 1145 | 1141 | |

*90E - size available for Star 60 doors only; 90Z - size available for Comfort 60 and Premium 60 doors only

**for metal doors in EI30 design

COMFORT, PREMIUM, STAR

| SIZE | CORNER FRAME WITH FT GASKET | | | | | | | | | INSTALLATION HOLE | | |
|--------------|-----------------------------|------|------|------|------|------|--------|--------|------|-------------------|------|------|
| | J | J** | K | K** | L | L** | M | N | O | X | X** | Y |
| 80N | 765 | 761 | 799 | 795 | 872 | 868 | 2005,5 | 2041,5 | 2078 | 829 | 825 | 2057 |
| 80 | 795 | 791 | 829 | 825 | 902 | 898 | | | | 859 | 855 | |
| 90N | 865 | 861 | 899 | 895 | 972 | 968 | | | | 929 | 925 | |
| 90E * | 908 | - | 942 | - | 1015 | - | | | | 972 | - | |
| 90Z * | 928 | 924 | 962 | 958 | 1035 | 1031 | | | | 992 | 988 | |
| 100E | 1008 | 1004 | 1042 | 1038 | 1115 | 1111 | | | | 1072 | 1068 | |

*90E - size available for Star 60 doors only; 90Z - size available for Comfort 60 and Premium 60 doors only

**for metal doors in EI30 design

GERDA DOOR AND FRAME DIMENSIONS

ADDITIONAL INFORMATION FOR INSTALLATION

OPENING DIRECTION FOR THE DOOR

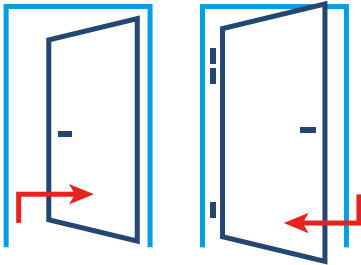

LEFT DOOR

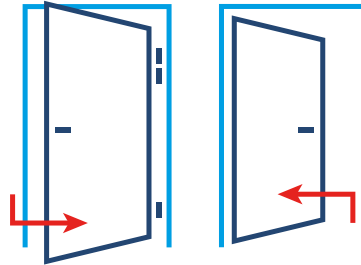

RIGHT DOOR

TECHNICAL DRAWINGS

FA

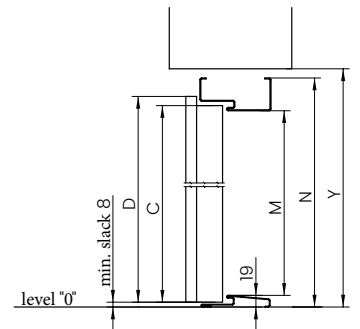
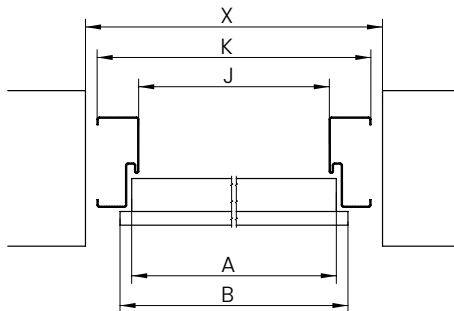
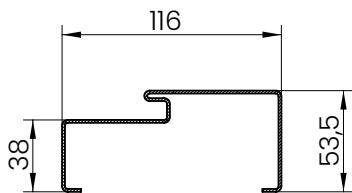

FT

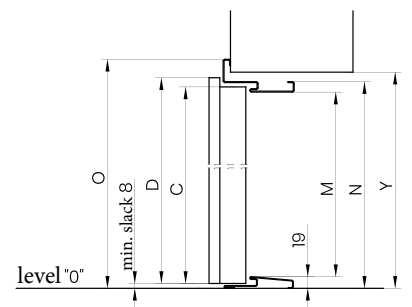
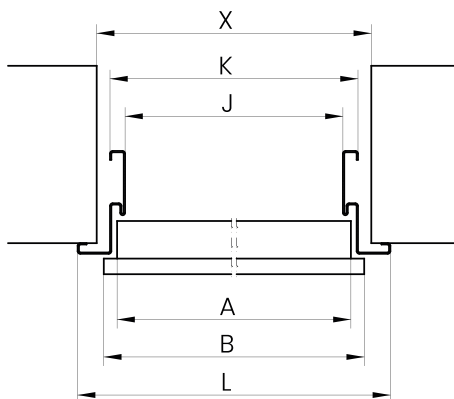
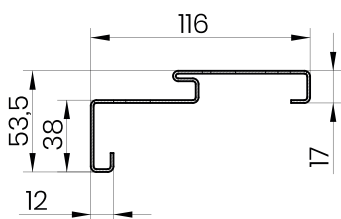

DOOR AND FRAME DIMENSIONS



ADDITIONAL INFORMATION FOR INSTALLATION

DOOR DIMENSIONS

| SIZE | METAL DOORS | | | | PANEL DOORS | | | |
|--------------|-------------|------|------|------|-------------|------|------|------|
| | A | B | C | D | A | B | C | D |
| 80N | 783 | 813 | 2025 | 2040 | 786 | 816 | 2025 | 2040 |
| 80 | 813 | 843 | | | 816 | 846 | | |
| 90N | 883 | 913 | | | 885 | 915 | | |
| 90E * | 926 | 956 | | | 929 | 959 | | |
| 90Z * | 946 | 976 | | | 949 | 979 | | |
| 100E | 1026 | 1056 | | | 1029 | 1059 | | |

*90E - size available for Star 60 doors only; 90Z - size available for Comfort 60 and Premium 60 doors only

FRAME DIMENSIONS

COMFORT, PREMIUM, STAR

| SIZE | ASYMMETRIC PORTAL FRAME WITH FA GROOVE | | | | | | | | | | INSTALLATION HOLE | | |
|--------------|--|------|------|------|---|-----|--------|------|---|----|-------------------|------|------|
| | J | J** | K | K** | L | L** | M | N | O | U | X | X** | Y |
| 80N | 765 | 761 | 872 | 868 | - | - | 2005,5 | 2078 | - | 95 | 902 | 898 | 2093 |
| 80 | 795 | 791 | 902 | 898 | - | - | | | | | 932 | 928 | |
| 90N | 865 | 861 | 972 | 968 | - | - | | | | | 1002 | 998 | |
| 90E * | 908 | - | 1015 | - | - | - | | | | | 1045 | - | |
| 90Z * | 928 | 924 | 1035 | 1031 | - | - | | | | | 1065 | 1061 | |
| 100E | 1008 | 1004 | 1115 | 1111 | - | - | | | | | 1145 | 1141 | |

*90E - size available for Star 60 doors only; 90X - size available for Comfort 60 and Premium 60 doors only

**for fire-resistant metal doors

COMFORT, PREMIUM, STAR

| SIZE | ASYMMETRIC PORTAL FRAME WITH FT GROOVE | | | | | | | | | | | INSTALLATION HOLE | | |
|--------------|--|------|------|------|------|------|--------|------|------|----------------|----------------|-------------------|------|------|
| | J | J** | K | K** | L | L** | M | N | O | U ¹ | U ² | X | X** | Y |
| 80N | 765 | 761 | 821 | 817 | 892 | 888 | 2005,5 | 2052 | 2088 | 95 | 101,5 | 857 | 853 | 2070 |
| 80 | 795 | 791 | 851 | 847 | 922 | 918 | | | | | | 887 | 883 | |
| 90N | 865 | 861 | 921 | 917 | 992 | 988 | | | | | | 957 | 953 | |
| 90E * | 908 | - | 964 | - | 1035 | - | | | | | | 1000 | - | |
| 90Z * | 928 | 924 | 984 | 980 | 1055 | 1051 | | | | | | 1020 | 1016 | |
| 100E | 1008 | 1004 | 1064 | 1060 | 1135 | 1131 | | | | | | 1100 | 1096 | |

*90E - size available for Star 60 doors only; 90X - size available for Comfort 60 and Premium 60 doors only

**for fire-resistant metal doors

¹ dimension for metal doors

² dimensions for panel doors

GERDA DOOR AND FRAME DIMENSIONS

ADDITIONAL INFORMATION FOR INSTALLATION

OPENING DIRECTION FOR THE DOOR

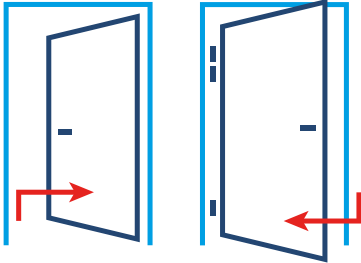

LEFT DOOR

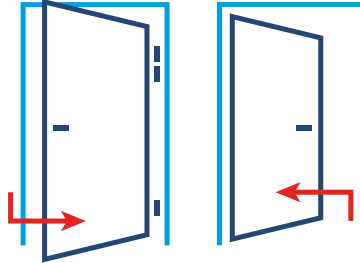

RIGHT DOOR

TECHNICAL DRAWINGS

ASYMMETRIC PORTAL FRAME WITH FA GROOVE

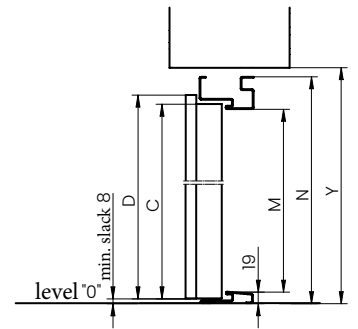
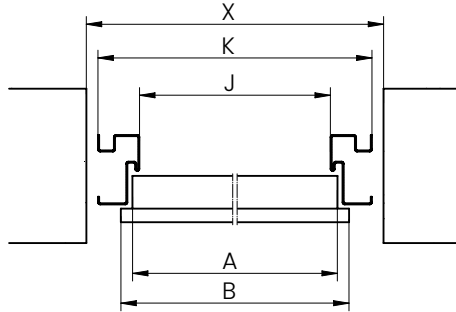
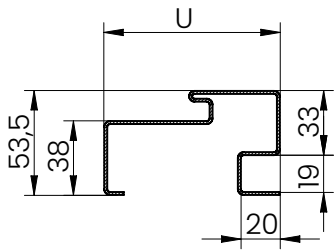

ASYMMETRIC PORTAL FRAME WITH FT GROOVE

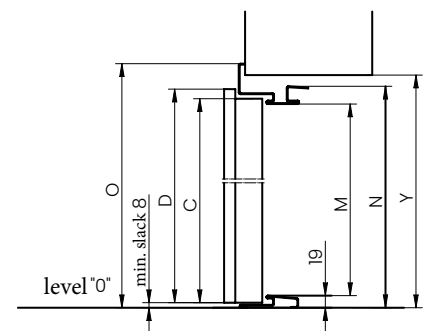
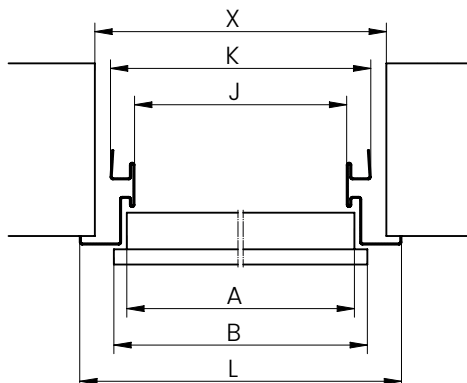
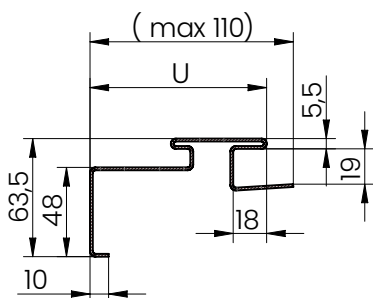

ACCESSORIES AND FIXTURES

GERDA®

INVENTORY

| HANDLES | | | COMFORT | PREMIUM | STAR |
|---|--|----------------------------|---------|---------|------|
|  | BERGEN - handles on long escutcheon TD300 | RC2 RC3 | ✓ | ✓ | - |
|  | BERGEN - handles on a split escutcheon | | ✓ | ✓ | - |
|  | BLOK handle on long escutcheon TD1000 | RC4 | - | ✓ | - |
|  | BLOK handle on long escutcheon TD300 | RC2 RC3 | ✓ | ✓ | - |
|  | BLOK-knob handle on long escutcheon TD300 / TD1000 | RC2 RC3 RC4 | ✓ | ✓ | - |
|  | BLOK - handles on long escutcheon | | ✓ | ✓ | - |
|  | OSLO - handles on long escutcheon | | ✓ | ✓ | - |
|  | TECHNO - the handle on a split escutcheon | | - | - | ✓ |
|  | TECHNO - the knob handle on a split escutcheon | | - | - | ✓ |











| ESCUTCHEONS | | | COMFORT | PREMIUM | STAR |
|---|---|--------------------|---------|---------|------|
|  | BERGEN - handles on long escutcheon TW300 | RC2 RC3 | ✓ | ✓ | - |
|  | BERGEN - split escutcheon without cylinder protection | | ✓ | ✓ | - |
|  | BLOK - split escutcheon with cylinder protection TW1000 | RC4 | ✓ | ✓ | - |
|  | BLOK - split escutcheon with cylinder protection TW200 | RC2 | ✓ | ✓ | - |
|  | BLOK - split escutcheon without cylinder protection | | ✓ | ✓ | - |
|  | OSLO - split escutcheon with cylinder protection | RC2 | ✓ | ✓ | - |
|  | OSLO - split escutcheon without cylinder protection | | ✓ | ✓ | - |

GERDA ACCESSORIES

COMFORT

PREMIUM

STAR









| | | | | |
|---|---|---|---|---|
|  | 50/85 WIDE ANGLE PEEPHOLE | ✓ | ✓ | ✓ |
|  | ELECTRONIC PEEPHOLE 2,4" / 4,3" | ✓ | ✓ | ✓ |
|  | HINGE CAPS FI 18 | - | - | ✓ |
|  | 3D HINGE CAPS FI 16 mm | ✓ | ✓ | - |
| | GEZE DOOR CLOSER GT 1500 STANDARD | ✓ | ✓ | ✓ |
|  | GEZE DOOR CLOSER GT 1500 LOCK | ✓ | ✓ | ✓ |
| | GEZE DOOR CLOSER GT 3000 STANDARD | ✓ | ✓ | ✓ |
| | GEZE DOOR CLOSER GEZE GT 3000 LOCK | ✓ | ✓ | ✓ |
|  | NORWEGIAN THRESHOLD 19 mm WITH AN OVERLAY ALUMINIUM | ✓ | ✓ | ✓ |
|  | NORWEGIAN THRESHOLD 28 mm WITH AN OVERLAY ALUMINIUM AVAILABLE IN 3 COLOURS (BRONZE, LIGHT BRONZE, BRIGHT) | ✓ | ✓ | ✓ |
|  | NORWEGIAN THRESHOLD 28 mm WITH AN OVERLAY ALUMINIUM AND INSERT WOODEN AVAILABLE IN 3 COLOURS (BRONZE, LIGHT BRONZE, BRIGHT) | ✓ | ✓ | ✓ |
|  | METAL THRESHOLD 19 mm (MATCHING THE FRAMES) | ✓ | ✓ | ✓ |
|  | ASSEMBLY THRESHOLD | ✓ | ✓ | ✓ |
|  | INOX THRESHOLD 19 mm/32 mm | ✓ | ✓ | ✓ |

ACCESSORIES AND FIXTURES

GERDA®

INVENTORY

GERDA ACCESSORIES

| | | | COMFORT | PREMIUM | STAR |
|---|---|-------------------|---------|---------|------|
|  | FAIL-SECURE ELECTRIC STRIKE | RC2 RC3 RC4 | ✓ | ✓ | ✓ |
| | FIRE-RESISTANT FAIL-SECURE ELECTRIC STRIKE NC | RC2 RC3 RC4 | - | ✓ | - |
|  | LAMINATED CLOSURE STRIP* | | ✓ | ✓ | ✓ |
|  | NUMERIC KEYPAD FOR ACCESS CONTROL | | ✓ | ✓ | ✓ |
|  | IMPULSE POWER SUPPLY PSC12015 RECOMMENDED FOR DOORS EQUIPPED WITH AN ELECTRIC DOOR STRIKE | | ✓ | ✓ | ✓ |
|  | MORTAR VARNISH 12 ml | | ✓ | ✓ | ✓ |
|  | CYLINDER MAINTENANCE PREPARATION 25 ml | | ✓ | ✓ | ✓ |
|  | CYLINDER MAINTENANCE PREPARATION 100 ml | | ✓ | ✓ | ✓ |
|  | CYLINDER MAINTENANCE PREPARATION 400 ml | | ✓ | ✓ | ✓ |
|  | DOOR MAINTENANCE PREPARATION | | ✓ | ✓ | ✓ |

*LAMINATE CLOSING LIST | Necessary when shortening the leaf independently in the range (20, 30, 40, 50, 60, 70 and 20,35) and (20 i 35 mm) for RC4.
Not available for door Fire-Resistant and ELITE

LOCK CYLINDER SETS IN 1 GERDA DOOR KEY SYSTEM



COMFORT 60 I PREMIUM 60

| SIZE | MASTER LOCK | SECONDARY LOCK | NUMBER OF KEYS | LOCK CYLINDER CLASS |
|-------------------------|----------------|-----------------------|----------------|---------------------|
| 35/50 ; 30/50* ; 35/55* | Sprocket wheel | SPROCKET CARRIER/KNOB | 5 + ASSEMBLY | CLASS 5 |
| 35/50 ; 30/50* ; 35/55* | Sprocket wheel | SPROCKET CARRIER/KNOB | 5 + ASSEMBLY | CLASS 6 |

* using the TW 300 BERGEN escutcheon

** using the TW1000 BLOK, TW200 BLOK escutcheon for doors opening outside

PREMIUM 60 WITH ELITE PACK

| SIZE | MASTER LOCK | SECONDARY LOCK | NUMBER OF KEYS | LOCK CYLINDER CLASS |
|------------------|----------------|-----------------------|----------------|---------------------|
| 35/55* ; 55/35** | Sprocket wheel | SPROCKET CARRIER/KNOB | 5 + ASSEMBLY | CLASS 5 |
| 35/55 | Sprocket wheel | SPROCKET CARRIER/KNOB | 5 + ASSEMBLY | CLASS 6 |

* for doors opening outside

** for doors opening inside

GERDA DOOR LOCK CYLINDERS



STAR 60

| SIZE | MASTER LOCK | SECONDARY LOCK | NUMBER OF KEYS | LOCK CYLINDER CLASS |
|--------------------|-------------|-----------------------|----------------|---------------------|
| - | RIM 6000 | - | 5 | CLASS 6 |
| G35/50* ; G55/35** | | SPROCKET CARRIER/KNOB | 5 + ASSEMBLY | CLASS 5 |
| G35/50* ; G55/30** | | SPROCKET CARRIER/KNOB | 5 + ASSEMBLY | CLASS 6 |

* for doors opening outside

** for doors opening inside

STAR 60

| SIZE | MASTER LOCK | SECONDARY LOCK | NUMBER OF KEYS | LOCK CYLINDER CLASS |
|--------------------|-------------|-----------------------|----------------|---------------------|
| - | RIM 6000 | - | 5 | CLASS 6 |
| G35/50* ; G55/35** | | SPROCKET CARRIER/KNOB | 5 + ASSEMBLY | CLASS 5 |
| | | SPROCKET CARRIER/KNOB | 5 + ASSEMBLY | CLASS 6 |

* for doors opening outside

** for doors opening inside

A VARIETY OF COLOURS **GERDA**®

CHOOSE YOUR DOOR COLOUR

DOOR COLOURS INCLUDING PANELS, SKIRTING BOARDS AND FRAMES OF THE ELITE PACK

ALPINE NUT



BRAZIL NUT



LIGHT WALNUT



GOLDEN OAK



WINCHESTER



DOOR COLOURS INCLUDING PANELS, SKIRTING BOARDS AND FRAMES OF THE ELITE PACK

LIGHT WENGE



WHITENED WENGE



WHITE



STEEL-GREY



ANTHRACITE

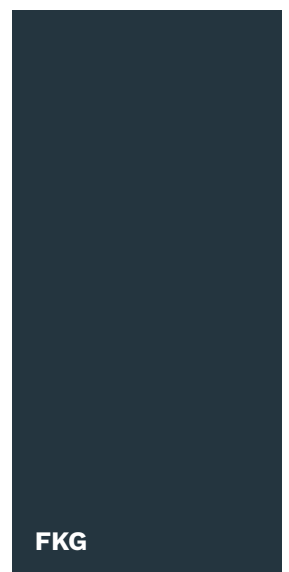

ADDITIONAL COLOURS OF ELITE PACK PANELS

SILICON



MARBLE



HAEMATITE



QUARTZ



WENGE



DOOR COLOURS INCLUDING PANELS, SKIRTING BOARDS AND FRAMES OF THE ELITE PACK

ADDITIONAL COLOURS OF SKIRTING BOARDS AND FRAMES OF ELITE PACK

DARK ANTHRACITE

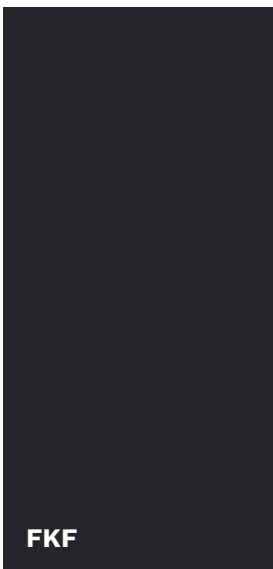

BLACK



GREY

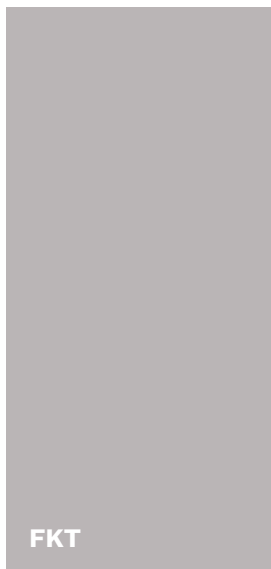

DARK BROWN

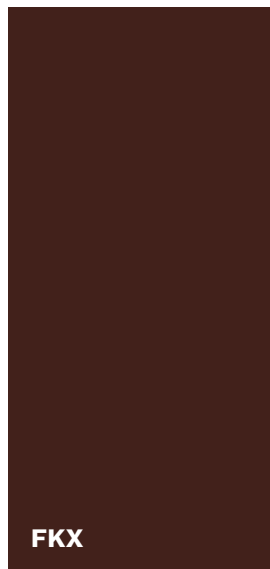

WENGE



INSPIRATIONS HIDDEN IN OUR CREATIONS



OUR DOORS INSTALLED IN POLISH APARTMENTS

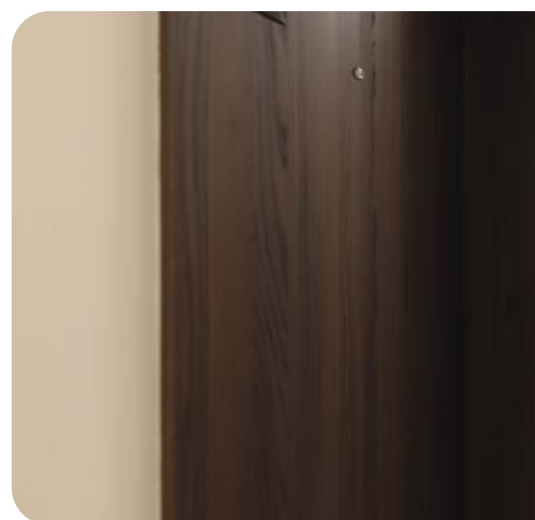

GERDA[®] INSPIRATIONS HIDDEN IN OUR CREATIONS

OUR DOORS INSTALLED IN POLISH APARTMENTS

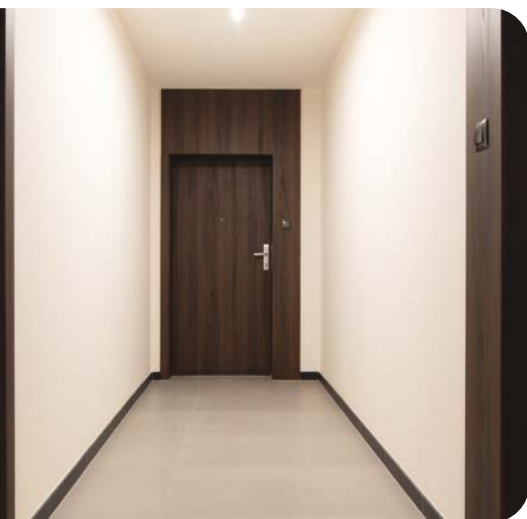



GERDA[®]

Gerda Sp. z o.o.

Sokołów, ul. Sokołowska 49

05-806 Komorów

Phone: (+48 22) 329 10 30

www.gerda.pl

This product catalogue does not constitute an offer within the meaning of law and is for information purposes only.

Gerda, aiming to improve the quality of its products and services, reserves (without prior notice) the right to make changes to products which, due to the process of preparing printed materials, may not be included in this material.

Despite efforts to carefully control the information presented, factual or printing errors may occur.

The colours presented in the catalogue may differ from the original due to a different colour reproduction technique in the printing process.

The owner of copyrights of this catalogue and Gerda logos and graphic elements is Gerda Sp. z o.o.

It is forbidden to copy and distribute any content and materials without the prior consent of Gerda Sp. z o.o.