

GERDA®

PREMIUM DOOR MANUFACTURER



APARTMENT DOORS

STAR | PREMIUM | COMFORT | ENJOY

TABLE OF CONTENTS

GERDA®

STEP BY STEP TO YOUR NEW DOOR

COMPANY INFORMATION	3
NEW ARRIVALS	4
ELITE PACKAGE (PANEL CONSTRUCTION DOOR)	5
COMFORT AND SAFETY	6
TEDEE POWERED BY GERDA	7
GERDA STAR 60 DOOR	10-13
GERDA PREMIUM 60 DOOR	14-17
GERDA COMFORT 60 DOOR	18-21
GERDA ENJOY DOOR	22-25
PORTALS AND DOOR TRIMS	26
STEEL CLAMPS	29
ACCESSORIES AND FIXTURES	30
DOOR COLOURS	34
DOOR AND FRAME DIMENSIONS	38
INSPIRATIONS	48-50

PRODUCTS WITH THE BRAND'S QUALITY GUARANTEE



GERDA®

We have created products that have already become iconic and millions of Poles have welcomed them in their homes. GERDA is associated with safety, reliability and comfort. We do our best to continuously improve our products.

POLISH MANUFACTURER WITH TRADITION AND EXPERIENCE



35 YEARS GERDA®

GERDA is a Polish manufacturer of doors, locks, fittings and sectional garage doors. The company has been appreciated for over 35 years by partners, assemblers and users. We design and create with passion! Our customers receive modern, durable and reliable products. We are worthy of trust!

PRODUCTS KNOWN ACROSS POLAND

DOORS



FITTINGS



GATES



NEW ARRIVALS

GERDA®

OUR STANDARD PROVIDES YOU WITH MORE THAN OTHERS

WITH OUR CUSTOMERS IN MIND, THE TEAM OF ENGINEERS AND CONSTRUCTORS IS CONSTANTLY WORKING ON MODIFICATIONS THAT IMPROVE SAFETY AND COMFORT OF USE

ADJUSTABLE 3D HINGE

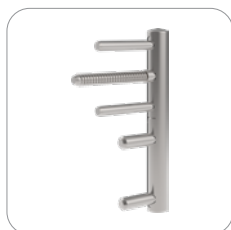

The new hinges with 3-way adjustments are now standard in the COMFORT 60 and PREMIUM 60 lines. This solution provides a very convenient and quick way of adjusting the door, without having to dismantle the leaf from the frame.

ADJUSTABLE LATCH CATCH OF THE HANDLE



An adjustable latch catch is offered in all the doors from the apartment doors offer. It enables the smooth adjustment of the leaf pressure to the gaskets. Thanks to this solution, adjusting the pressure is always easy (reduce or increase the pressure on the gasket).

IMPROVED ACOUSTIC PACK

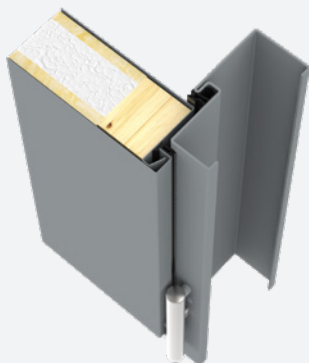

The use of innovative gaskets in leaves and FRAMES that form one plane provides very good acoustic properties. Noise from the staircase does not penetrate the apartment.



PREMIUM LOCKS AS STANDARD

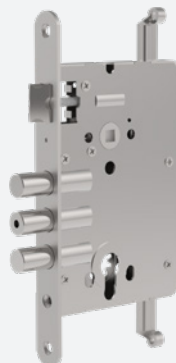

All apartment doors have been equipped with PREMIUM locks, in which deadbolts with a safe design have been reinforced by 30%. Additionally, market-unique reinforcement of internal deadbolts made of hardened steel has been applied.



LARGE SELECTION OF ESCUTCHEONS AND HANDLES

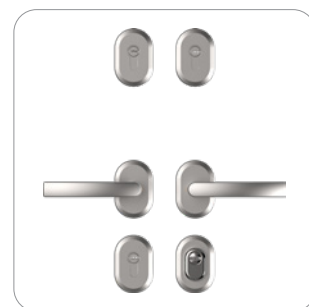
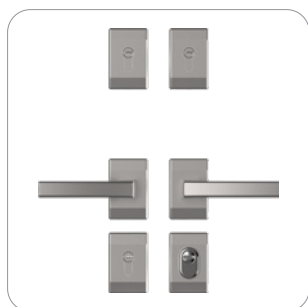

The possibility to customise the appearance of the door thanks to a wide range of oval, oblong and split ESCUTCHEONS in the COMFORT and PREMIUM series.

YOU DECIDE WHAT YOUR DOOR WILL LOOK LIKE

PANEL-TYPE DOORS HAVE A MULTI-LAYER LEAF WITH A STEEL BOX BODY AND REPLACEABLE CLADDINGS ON BOTH SIDES

PANEL STRUCTURE

Panel doors will be perfect as apartment front doors and their appearance can be customised. The panels are mounted to the steel body making the door sturdier and bracing the leaf. Upon the customer's request, the panels can vary in colour on the inside and the outside. The well-thought-out method of mounting the panels to the body enables easy disassembly and replacement in case of damage or rearrangement, without the need for a costly replacement of the entire door.



**DISMANTLE
THE EXISTING PANEL**



**CHOOSE A COLOUR
FROM THE ELITE
PACKAGE**



**ENJOY THE NEW LOOK
OF YOUR DOOR**

COMFORT AND SAFETY



WHAT YOU SHOULD KNOW ABOUT GERDA DOORS



ANTI-BURGLARY

All our doors are structurally reinforced, with solutions that make it difficult to force them open. They are also equipped with an anti-burglary lock cylinder, which is what GERDA is renowned for. However, for the antiburglary parameters to be confirmed, the door must pass specialised tests and trials for RC2, RC3 and RC4 classes, concluded with the issuance of an appropriate certificate. GERDA doors possess such certificates and approvals. They can be downloaded at any time from www.gerda.pl. The doors offered by GERDA can be bought in class RC2, RC3 and RC4 (detailed explanations at the bottom of the page).



EXCELLENT ACOUSTIC COMFORT

When buying a door, acoustic comfort must be taken into consideration in order to ensure that as little sound as possible comes into our apartment. The sound reduction index (R_w) is expressed in dB (decibels). The higher the value of the index, the better the sound reduction of the door. Our apartment doors have a very good sound reduction index (from 33 to even 47 dB). If there is 80 dB of sound coming from the outside (this corresponds to loud music) it will be reduced from 33-47 dB to even 33 dB, which is the level of a silent conversation.





FIRE PROTECTION





In our offer of GERDA apartment doors, you can also choose a fire protection pack (available in the PREMIUM 60 series). Fire-resistant doors are designed to stop the spread of fire and smoke. Products with the aforementioned properties are marked with the symbol EI (fire integrity criterion - E and fireproof insulation - I). GERDA offers doors with EI30, EI45 and EI60 parameters which mean the protection lasts for 30, 45 and 60 minutes respectively. The owner of such a door has a guarantee that the flames will not pass through the door for the indicated time and that the door temperature will not cause the fire to spread. The smoke-proofing class is S200.

ANTI-BURGLARY CLASSES

RC2 CLASS

-  PLIERS
-  WEDGE
-  HAMMER

RC3 CLASS

-  STEEL CROWBAR
-  WEDGE
-  HAMMER
-  MECHANICAL DRILL

RC4 CLASS

-  HEAVY HAMMER
-  AXE
-  GOUGE
-  CHISEL
-  DRILL

TURN YOUR SMARTPHONE INTO A SMART DOOR LOCK



OPEN DOORS WITH YOUR SMARTPHONE

Open and close doors and monitor door lock status from any place around the world. With the automatic opening feature, you don't need to take your phone out from your purse or pocket. The lock will detect your presence and let you in. The self-locking feature works based on the same principle.

HIGH-PERFORMANCE BATTERY

Gerda engineers, in collaboration with the South Korean Research Institute, have developed a small dedicated high-performance battery. It powers the mechanism for six months of operation. And when in need of recharging, the lock will let you know as you can charge the battery overnight.

SAFETY WARRANTY

The lock actuating mechanism is an innovative, patented design developed by Gerda engineers. The software was created by Tedee IoT experts. An intuitive app lets you keep track of who and when has locked or unlocked the door. It also offers a virtual key allocation feature.

SET

TEDEE LOCK + TEDEE BRIDGE + CLASS 6 LOCK CYLINDERS



CLASS 6 LOCK CYLINDERS INCLUDED

- ✓ ANTI-BURGLARY TUMBLER LOCK INSERT. NEW LOCK INSERT DESIGN SECURED AGAINST 'LOCK BUMPING', WITH EFFECTIVE DRILL OPENING PROTECTION.



INSTALL A TEDEE LOCK

- ✓ SLIDE THE LOCK ONTO A GERDA INSERT, ADJUST THE LOCK POSITION AND SECURE IT WITH ONE BOLT. INSTALLATION TAKES NO MORE THAN TWO MINUTES. INSPECT TO SEE WHETHER THE BOLTS SLIDE UPON TURNING THE KNOB.



INSTALL THE SMARTPHONE APP

- ✓ DOWNLOAD THE TEDEE APP FROM APPLE STORE OR GOOGLE PLAY. SIGN UP AND ACTIVATE YOUR BLUE-TOOTH, LOCATION SERVICE AND INTERNET ACCESS. ADD YOUR LOCK AND ENTER THE ACTIVATION CODE.



CONNECT THE BRIDGE

- ✓ FIND A FREE POWER SOCKET NEXT TO THE TEDEE LOCK AND PLUG THE BRIDGE IN. THIS WILL ENABLE YOU TO CONTROL THE LOCK OVER THE INTERNET FROM WHEREVER YOU ARE.

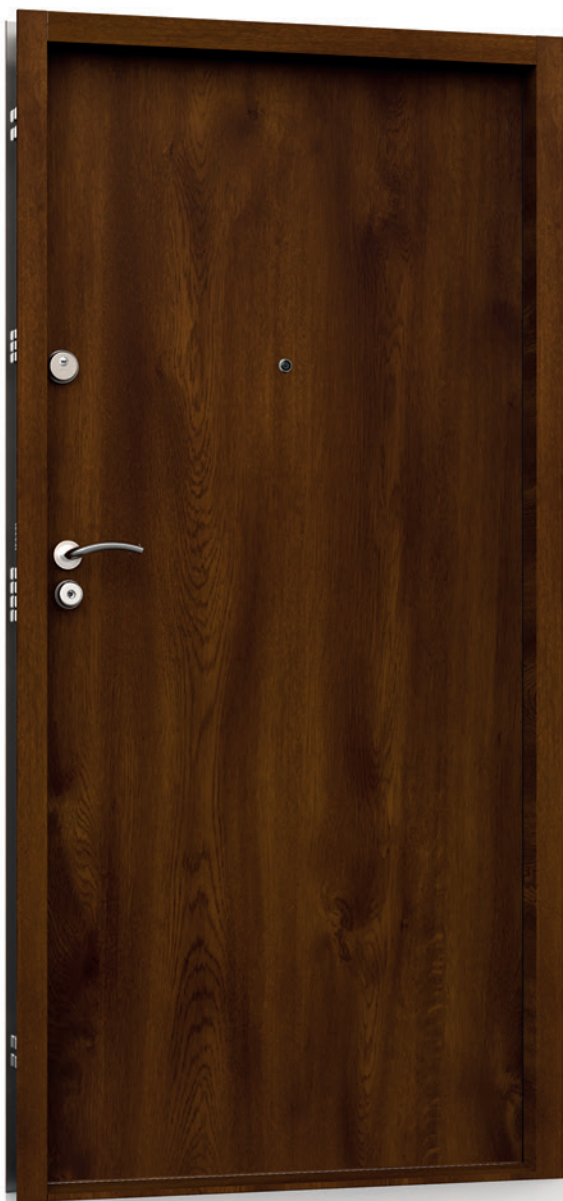

STAR 60

RC ANTI-BURGLARY PROTECTION CLASS RC4

mm LEAF THICKNESS 60 / 70 mm

dB SOUND REDUCTION INDEX 43 / 47 dB

ELITE ELITE PANEL CONSTRUCTION



PREMIUM 60

RC ANTI-BURGLARY PROTECTION CLASS RC2 / RC3 / RC4

mm LEAF THICKNESS 60 / 70 mm

dB SOUND REDUCTION INDEX 42 dB

ELITE FIRE RESISTANCE CLASS EI30 / EI45 / EI60
AND SMOKE TIGHTNESS CLASS S₂₀₀

ELITE ELITE PANEL CONSTRUCTION



COMFORT 60



ANTI-BURGLARY PROTECTION CLASS RC2 / RC3



LEAF THICKNESS 60 mm



SOUND REDUCTION INDEX 30 / 33 dB

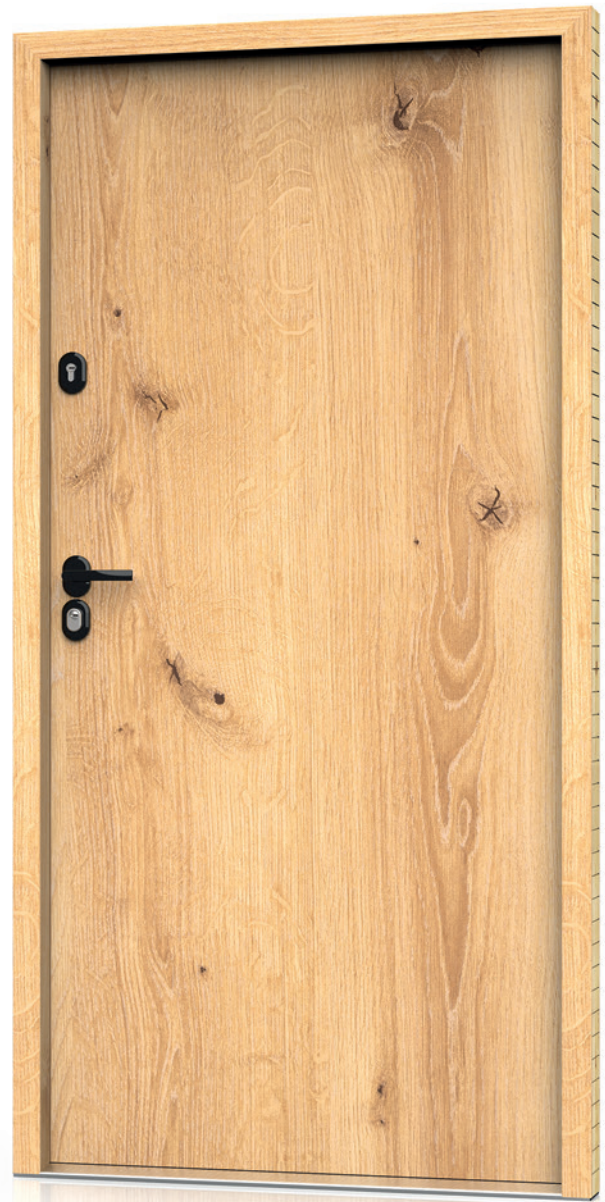

ENJOY



ANTI-BURGLARY PROTECTION CLASS RC1N / RC2







LEAF THICKNESS 46 mm



SOUND REDUCTION INDEX 32 dB



PARAMETERS

	ANTI-BURGLARY PROTECTION CLASS	RC4
	LEAF THICKNESS / WITH ELITE PACKAGE*	60 / 70* mm
	SOUND REDUCTION INDEX / ELITE PACKAGE*	43 / 47* dB
	LEAF STRUCTURE	POLYURETHANE FOAM FILLING + SOUNDPROOFING PACK + LATTICE
	DOOR SIZES	80N, 80, 90N, 90E, 100E*

EXCELLENT ACOUSTIC COMFORT AND THE HIGHEST LEVEL OF SAFETY



UNIQUE TUBULAR KEY

Patented RIM6000 lock cylinder with a tubular key with over 4 billion code combinations.

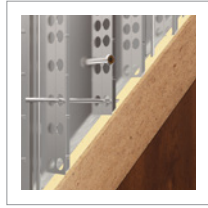

FILLING

HCFC-free polyurethane foam with a soundproofing plate providing excellent acoustic performance.



LATTICE

A lattice with thickened steel channel bars and hardened rods in the steel body of the door leaf.

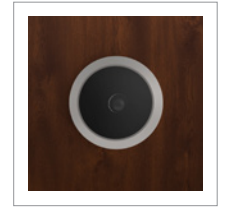

VIEWER

Wide-angle viewer as standard with a very good optical performance.

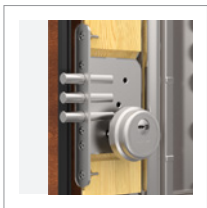

ADDITIONAL LOCK

Additional class 6 lock with a class 5 or class 6 lock cylinder.

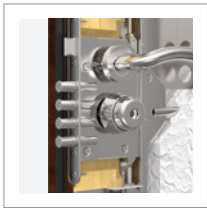

**MAIN LOCK
14 LOCKING POINTS**

Unique class 7 main lock with 11 mobile and thickened bolts.

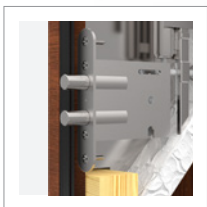

AUXILIARY LOCKS

Auxiliary upper and lower locks controlled from the main lock.



3 THREE-PIECE HINGES

Reinforced three-piece hinges with a disassembly lock and elegant caps.



3 MOVABLE DEADBOLTS

Reinforced horizontal deadbolts on the hinge sides controlled from the main lock.

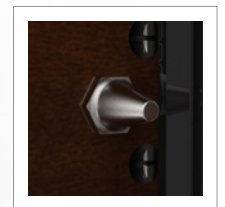

3 FIXED BOLTS

Fixed bolts protecting against forcing the door.

DOOR FRAMES



FA

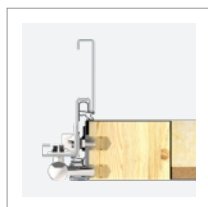

FT

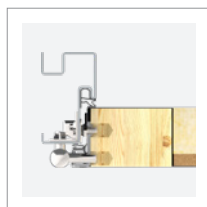

FA PORTAL for door portal or door trim installation



FT PORTAL for door portal or door trim installation



RIGID CHAIN*

* EXTRA CHARGE

WOO PLAIN



WOO PLAIN

DOOR LEAF DESIGNS WITH INOX INSERTS*



TML TOKIO 1
INSERT

TMM TOKIO 2
INSERT

SIZE	80N	80	90N	90E	100E*
-------------	-----	----	-----	-----	-------

MODEL

STAR 60

WOO PLAIN

RC4 STANDARD EQUIPMENT

STAR 60 DOOR LEAF (43 dB)	WIDE-ANGLE VIEWER
DOOR FRAME WITH SEAL	TECHNO HANDLES
3-PIECE HINGES WITH CAPS MATCHING FITTING'S COLOUR	CLASS 6 MAIN LOCK CYLINDER
LAMINATED THRESHOLD WITH SEAL 19 mm / 32 mm	CLASS 5 ADDITIONAL LOCK CYLINDER
FITTINGS SET WITH LOCK CYLINDER PROTECTION	

EXTRA CHARGES

SIZE 100E	2.4" ELECTRONIC VIEWER
TWO-COLOUR DOOR	4.3" ELECTRONIC VIEWER
DOOR SHORTENING (20, 30, 40, 50, 60, 70 mm)	INOX THRESHOLD WITH SEAL HEIGHT 19 OR 32 mm
ELITE PACKAGE – PLAIN PANEL ELITE PACKAGE – PATTERN PANEL	NORWEGIAN WOODEN THRESHOLD WITH SEAL 19 mm
SINGLE-SIDE PATTERN TML TOKIO 1 INSERT, TMM TOKIO 2 INSERT	NORWEGIAN WOODEN THRESHOLD WITH ALUMINIUM STRIP AND SEAL HEIGHT 28 mm
DOUBLE-SIDE PATTERN TML TOKIO 1 INSERT, TMM TOKIO 2 INSERT	NORWEGIAN WOODEN THRESHOLD WITH WOODEN STRIP AND SEAL HEIGHT 35 mm ¹
HANDLE-KNOB	RIGID CHAIN (WITHOUT ELITE PACKAGE) ^{1,2}
ADDITIONAL CLASS 6 LOCK CYLINDER	TEDEE SET

¹ For frames extended by 6 mm, with the DPO mounting system
² For frames with the DPO mounting system (frame dowel joint), metal doors

DOOR COLOURS (INCLUDING PANELS, SKIRTING BOARDS AND FRAMES OF THE ELITE PACKAGE*)

ALPINE WALNUT FRR	BRAZIL WALNUT FRB	LIGHT WALNUT FRP	GOLDEN OAK FDE	WINCHESTER FDW	LIGHT WENGE FEJ
WHITENED WENGE FBJ	WHITE FSB	STEEL GREY FKZ	ANTHRACITE FKG	DARK ANTHRACITE FKF	BLACK FKC

ADDITIONAL COLOURS OF ELITE PACKAGE PANELS*

SILICON FKL FLAT DESIGN ONLY	MARBLE FKA FLAT DESIGN ONLY	HEMATITE FDF FLAT DESIGN ONLY	QUARTZ FKH FLAT DESIGN ONLY	WENGE FEE
---	--	--	--	---------------------

ADDITIONAL COLOURS OF SKIRTING BOARDS AND FRAMES OF THE ELITE PACKAGE*

GREY FKT	DARK BROWN FKX	WENGE FEE
--------------------	--------------------------	---------------------

EXCELLENT ACOUSTIC COMFORT AND THE HIGHEST LEVEL OF SAFETY

DOOR LEAF DESIGNS WITH ELITE PACKAGE*

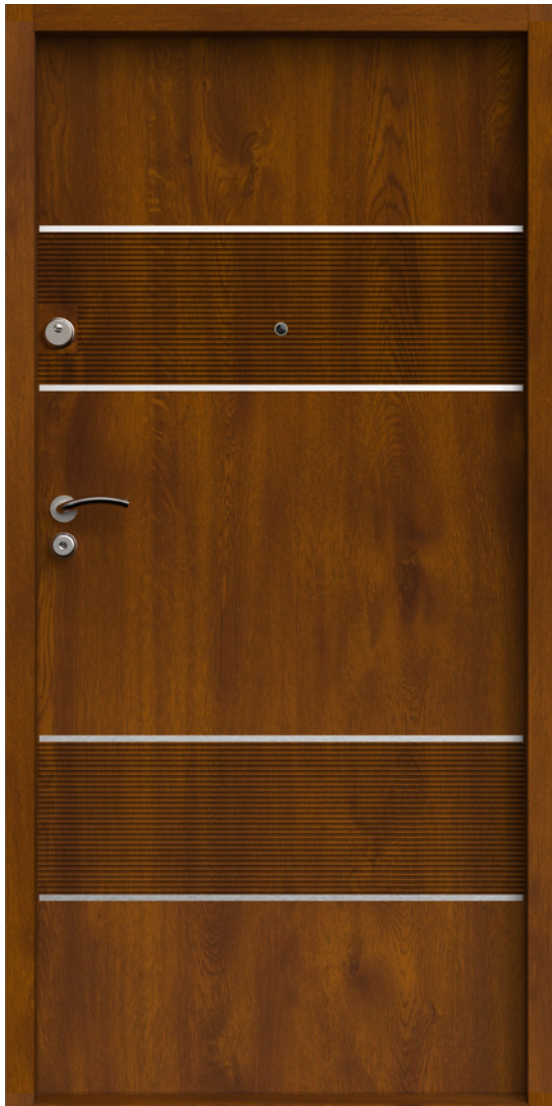

RHH ELITE package



R00 PLAIN ELITE package



RLF ELITE package



VA3 ELITE package



VA4 ELITE package

FITTINGS

RC4

**RIM 6000
TECHNO**

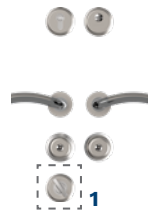

DUO-COLOUR
FITTINGS

SATIN NICKEL



GLOSSY CHROME

1 rigid chain
(without ELITE package)*

DOOR FRAMES

FA



FT



THRESHOLDS

LAMINATED



WITH SEAL
HEIGHT 19 mm

INOX*

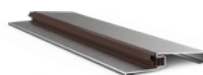

WITH SEAL
HEIGHT 19 mm

LAMINATED / INOX*

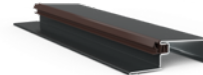

WITH SEAL
HEIGHT 32 mm

NORWEGIAN WOODEN*
(brown, light brown, light)

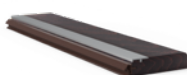

WITH SEAL
HEIGHT 19 mm

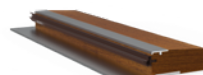

WITH ALUMINUM STRIP
AND SEAL, HEIGHT 28 mm

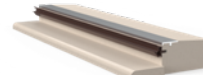







WITH WOODEN STRIP
AND SEAL, HEIGHT 35 mm

* EXTRA CHARGE



PARAMETERS

	ANTI-BURGLARY PROTECTION CLASS	RC2 / RC3* / RC4*
	LEAF THICKNESS / WITH ELITE PACKAGE*	60 / 70* mm
	SOUND REDUCTION INDEX	42 dB
	FILLING	SPECIAL SOUNDPROOFING PACKAGE
	FIRE RESISTANCE CLASS (FR)*	EI30^{AB} / EI45^B / EI60^A
	SMOKE TIGHTNESS CLASS	S200 (IN THE EI30^{AB} / EI45^B / EI60^A DOORS)
	DOOR SIZES	80N, 80, 90N, 90Z, 100E^{C*}

A. EI30 AND EI60 AVAILABLE IN RC2 AND RC3 CLASS*
 B. EI30 AND EI45 AVAILABLE IN RC4 CLASS*
 C. SIZE 100E NOT AVAILABLE IN RC4 AND EI60 CLASS*

RC2 / RC3* / RC4*

GERDA® PREMIUM 60

HIGH LEVEL OF SAFETY AND ACOUSTIC COMFORT ALSO IN THE FIRE-RESISTANT VERSION

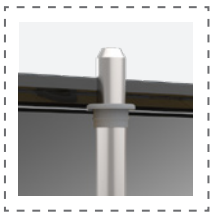

VERTICAL DEADBOLT*

Anti-burglary vertical deadbolt controlled from the main lock. Available in the RC3 pack.

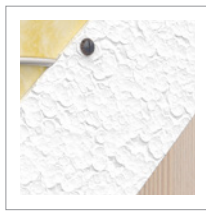

FILLING

Special filling for good acoustic comfort.



HARDENED BARS*

Specially developed design of thickened and hardened steel bar protecting against burglary. Available in RC3 and RC4 class.



EI30D* / EI45D* / EI60D*

PREMIUM 60 doors are also available with the fire-resistant pack.



VIEWER

Wide-angle viewer as standard with a very good optical performance.



ADDITIONAL LOCK

Additional top lock with burglar-proof class 5 or class 6 lock cylinder.



MAIN LOCK

Class 7 main lock with reinforced deadbolt construction with class 5 or class 6 anti-burglary lock cylinder.



AUXILIARY LOCKS*

Lower and upper auxiliary locks with a double deadbolt system controlled from the main lock. Available as a pack RC3 (1 pc) (lower) and RC4 (3 pc).

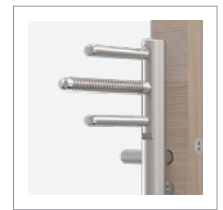

3D HINGE WITH CAPS

Hinges adjustable in three planes with caps matching fitting's colour.

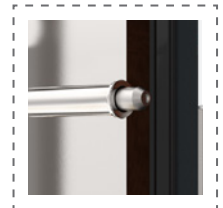

2 MOVABLE DEADBOLTS*

Reinforced horizontal deadbolts on the hinge sides controlled from the main lock. Available in RC4 class.

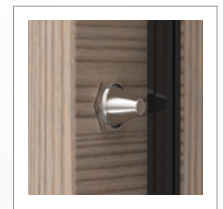

2 FIXED BOLTS

Fixed bolts protecting against forcing the door.

DOOR FRAMES



FA



FT

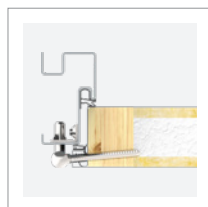

FA PORTAL

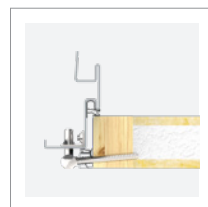
 for door portal or door trim installation

FT PORTAL

 for door portal or door trim installation

KEYED ALIKE SINGLE KEY SYSTEM



RIGID CHAIN*

* EXTRA CHARGE

WOO PLAIN



WOO PLAIN

DOOR LEAF DESIGNS
WITH INOX INSERTS*



TMM TOKIO 1
INSERT

TMM TOKIO 2
INSERT

SIZE	80N	80	90N	90Z	100E*
------	-----	----	-----	-----	-------

MODEL PREMIUM 60

WOO PLAIN

RC2 STANDARD ELEMENTS

PREMIUM 60 DOOR LEAF (42 dB)	FITTINGS SET WITH MAIN LOCK CYLINDER PROTECTION
DOOR FRAME WITH SEAL	WIDE-ANGLE VIEWER
ADJUSTABLE 3D HINGES WITH CAPS MATCHING FITTING'S COLOUR	HANDLES: BLOK, BERGEN OR OSLO
LAMINATED THRESHOLD WITH SEAL 19 mm OR 32 mm	CLASS 5 LOCK CYLINDERS IN SINGLE KEY SYSTEM

EXTRA CHARGES

RC3 PACKAGE	CLASS 6 CYLINDERS IN SINGLE KEY SYSTEM (STANDARD IN RC4 PACKAGE)
RC4 PACKAGE	INOX THRESHOLD WITH SEAL HEIGHT 19 OR 32 mm
FIRE PROTECTION PACKAGE WITH INTEGRATED CLOSER	NORWEGIAN WOODEN THRESHOLD WITH SEAL HEIGHT 19 mm
EI30	NORWEGIAN WOODEN THRESHOLD WITH ALUMINIUM STRIP AND SEAL HEIGHT 28 mm
EI45	NORWEGIAN WOODEN THRESHOLD WITH WOODEN STRIP AND SEAL HEIGHT 35 mm ¹
EI60	
2.4" ELECTRONIC VIEWER	SIZE 100E
4.3" ELECTRONIC VIEWER	RIGID CHAIN (WITHOUT RC4, FR AND ELITE PACKAGE) ^{1,2}
TWO-COLOUR DOORS	HANDLE-KNOB
DOOR SHORTENING (20, 30, 40 ³ , 50, 60 ³ , 70 mm) ⁴	UPPER ESCUTCHEON PROTECTION (STANDARD IN FIRE PROTECTION PACKAGE)
ELITE PACKAGE – FLAT PANEL	TEDEE SET
ELITE PACKAGE – PATTERN PANEL	
SINGLE-SIDE PATTERN	
TML TOKIO 1 INSERT, TMM TOKIO 2 INSERT	
DOUBLE-SIDE PATTERN	
TML TOKIO 1 INSERT, TMM TOKIO 2 INSERT	
DOOR HEIGHT RAISED 100 mm	
PREMIUM 60 (RC2, RC3) +EI30	
PREMIUM 60X (RC2, RC3) +EI30	

¹For frames extended by 6 mm, with the DPO mounting system
²For frames with the DPO mounting system (frame dowel joint), metal door

³Not applicable to fire-resistant doors

⁴In RC4 package cutting down in the range of 20, 35 mm

DOOR COLOURS (INCLUDING PANELS, SKIRTING BOARDS AND FRAMES OF THE ELITE PACKAGE*)

ALPINE WALNUT FRR	BRAZIL WALNUT FRB	LIGHT WALNUT FRP	GOLDEN OAK FDE	WINCHESTER FDW	LIGHT WENGE FEJ
WHITENED WENGE FBJ	WHITE FSB	STEEL GREY FKZ	ANTHRACITE FKG	DARK ANTHRACITE FKF	BLACK FKC

ADDITIONAL COLOURS OF ELITE PACKAGE PANELS*

SILICON FKL FLAT DESIGN ONLY	MARBLE FKA FLAT DESIGN ONLY	HEMATITE FDF FLAT DESIGN ONLY	QUARTZ FKH FLAT DESIGN ONLY	WENGE FEE
---	--	--	--	---------------------

ADDITIONAL COLOURS OF SKIRTING BOARDS AND FRAMES OF THE ELITE PACKAGE*

GREY FKT	DARK BROWN FKX	WENGE FEE
--------------------	--------------------------	---------------------

DOOR LEAF DESIGNS
WITH ELITE PACKAGE*



RLF ELITE package

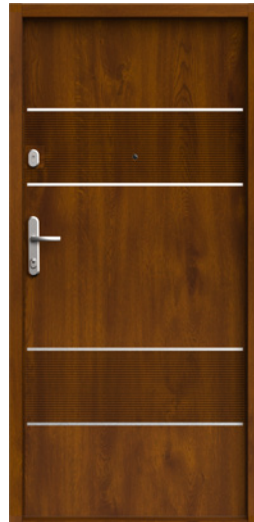

RHH ELITE package



VA3 ELITE package



VA4 ELITE package

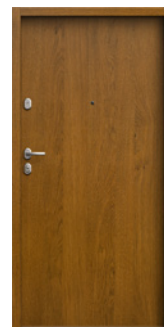

R00 PLAIN ELITE package

- 1 upper escutcheon without lock cylinder protection
- 2 upper escutcheon with lock cylinder protection (FR standard)*
- 3 rigid chain (without packages RC4, FR, ELITE)*
- 4 OSLO escutcheon not available for FR package

FITTINGS

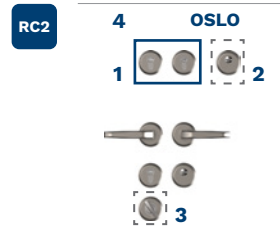
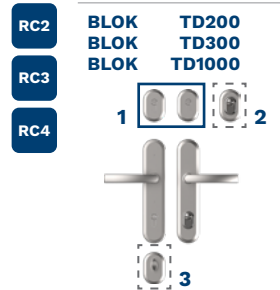
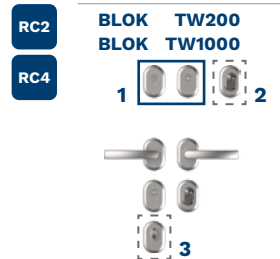
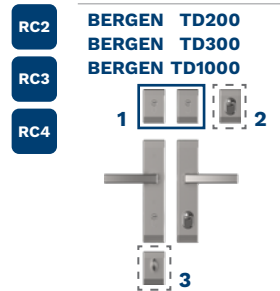
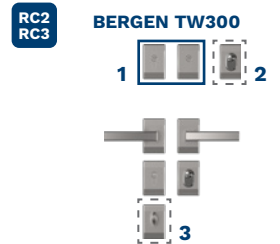

FITTINGS COLOUR
BERGEN, BLOK

PLATINUM ANODE



SILVER ANODE



BLACK ANODE



FITTINGS COLOUR
OSLO

SATIN NICKEL



DOOR FRAMES

FA



FT



THRESHOLDS

LAMINATED



WITH SEAL
HEIGHT 19 mm

INOX*

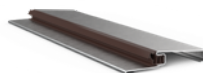

WITH SEAL
HEIGHT 19 mm

LAMINATED / INOX*

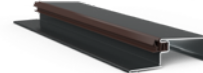

WITH SEAL
HEIGHT 32 mm

NORWEGIAN WOODEN*
(brown, light brown, light)

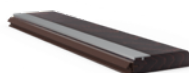

WITH SEAL
HEIGHT 19 mm

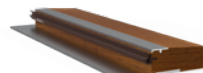

WITH ALUMINUM STRIP
AND SEAL, HEIGHT 28 mm

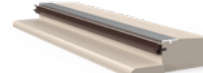

WITH WOODEN STRIP
AND SEAL, HEIGHT 35 mm



PARAMETERS

	ANTI-BURGLARY PROTECTION CLASS	RC2 / RC3*
	LEAF THICKNESS	60 mm
	SOUND REDUCTION INDEX	30 / 33* dB
	FILLING	SOUNDPROOFING PACKAGE
	DOOR SIZES	80N, 80, 90N, 90Z, 100E*

RC2 / RC3*

GERDA® COMFORT 60

GREAT COMFORT AND SAFETY AT A GOOD PRICE

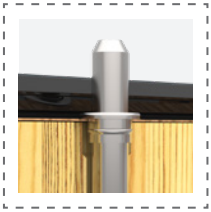

VERTICAL DEADBOLT*

Anti-burglary vertical bar controlled from the main lock. Available in the RC3 package.



FILLING

Special filling providing good acoustic comfort.



BARS*

Specially developed design of thickened and hardened steel bar protecting against burglary. Available in RC3 class.

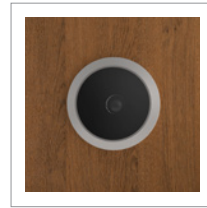

VIEWER

Wide-angle viewer as standard with very good optical parameters.



3D HINGE WITH CAPS

Hinges adjustable in three planes with caps matching fitting's colour.

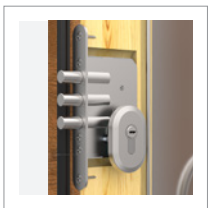

ADDITIONAL LOCK

Additional class 6 top lock with an anti-burglary class 5 or 6 lock cylinder.



MAIN LOCK

Class 7 main lock with thickened and reinforced deadbolt with class 5 or class 6 anti-burglar lock cylinder.

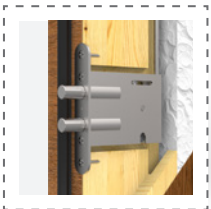

AUXILIARY LOCK*

Bottom auxiliary lock with double deadbolt system controlled from the main lock. Available in RC3 pack.

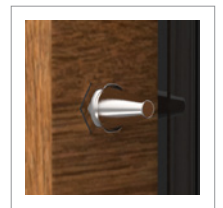
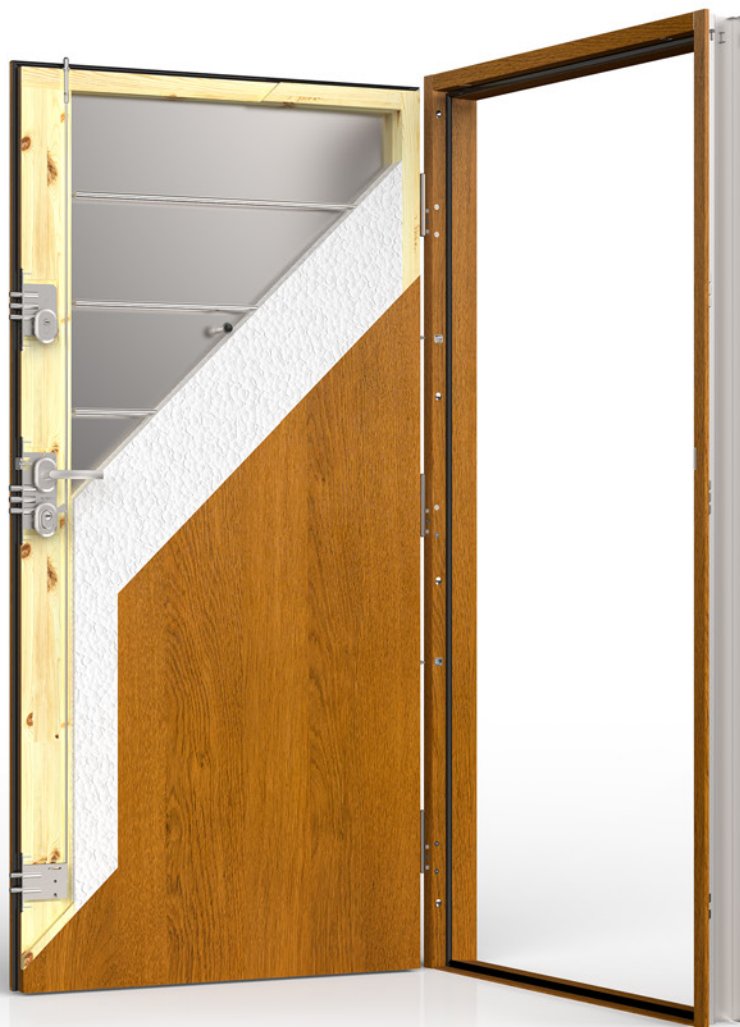

2 FIXED BOLTS

Fixed bolts protecting against forcing the door.



RIGID CHAIN*



SINGLE KEY SYSTEM

DOOR FRAMES



FD



FN



FA*



FT*

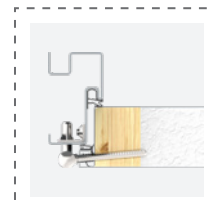

FA PORTAL*

for door portal or door trim installation

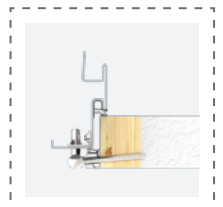

FT PORTAL*

for door portal or door trim installation

* EXTRA CHARGE

GREAT COMFORT AND SAFETY AT A GOOD PRICE

WOO PLAIN



WOO PLAIN

DOOR LEAF DESIGNS
WITH INOX INSERTS*



TML TOKIO 1
INSERT

TMM TOKIO 2
INSERT

SIZE	80N	80	90N	90Z	100E*
------	-----	----	-----	-----	-------

MODEL

COMFORT 60

WOO PLAIN

RC2 STANDARD ELEMENTS

COMFORT 60 DOOR LEAF (30 dB)	FITTINGS SET WITH MAIN LOCK CYLINDER PROTECTION
DOOR FRAME WITHOUT SEAL	WIDE-ANGLE VIEWER
ADJUSTABLE 3D HINGES WITH CAPS MATCHING FITTING'S COLOUR	HANDLES: BLOK, BERGEN OR OSLO
LAMINATED THRESHOLD WITH SEAL 19 mm OR 32 mm	CLASS 5 LOCK CYLINDERS IN SINGLE KEY SYSTEM

EXTRA CHARGES

SOUNDPROOFING PACKAGE 33 dB	CLASS 6 CYLINDERS IN SINGLE KEY SYSTEM
DOOR FRAME WITH SEAL	2.4" ELECTRONIC VIEWER
RC3 PACKAGE	4.3" ELECTRONIC VIEWER
SIZE 100E	INOX THRESHOLD WITH SEAL HEIGHT 19 OR 32 mm
DOOR SHORTENING (20, 30, 40, 50, 60, 70 mm)	PRÓG NORWESKI DREWNIANY Z USZCZELKĄ WYSOKOŚĆ 19 mm
SINGLE-SIDE PATTERN TML TOKIO 1 INSERT, TMM TOKIO 2 INSERT	NORWEGIAN WOODEN THRESHOLD WITH ALUMINIUM STRIP AND SEAL HEIGHT 28 mm
DOUBLE-SIDE PATTERN TML TOKIO 1 INSERT, TMM TOKIO 2 INSERT	NORWEGIAN WOODEN THRESHOLD WITH WOODEN STRIP AND SEAL HEIGHT 35 mm
TWO-COLOUR DOORS	RIGID CHAIN ^{1,2}
HANDLE-KNOB	UPPER ESCUTCHEON PROTECTION
DEEP STAMPING ³ DOUBLE-SIDE PATTERN: W13 LONDYN STAMPING, TMT TOKIO 1 STAMPING, TMU TOKIO 2 STAMPING, SR4 TROMSO 1 STAMPING	TEDEE SET
	DOORS HEIGHT RAISED 100 mm

¹For frame extended by 6 mm, with the DPO mounting system

²For frames with the DPO mounting system (frame dowel joint), metal door

³Patterns available for Comfort 60 RC2 / RC3 (30 dB)

DOOR FRAMES

FD



FN



FA*



FT*



DOOR COLOURS

ALPINE WALNUT

FRR

BRAZIL WALNUT

FRB

LIGHT WALNUT

FRP

GOLDEN OAK

FDE

WINCHESTER

FDW

LIGHT WENGE

FEJ

WHITENED WENGE

FBJ

WHITE

FSB

STEEL GREY

FKZ

ANTHRACITE

FKG

DARK ANTHRACITE

FKF

BLACK

FKC

GREAT COMFORT AND SAFETY AT A GOOD PRICE

DOOR LEAF DESIGNS WITH DEEP STAMPING*



W13 LONDYN STAMPING



TMT TOKIO 1 STAMPING



TMU TOKIO 2 STAMPING



SR4 TROMSO 1 STAMPING

THRESHOLDS

LAMINATED



WITH SEAL
HEIGHT 19 mm

INOX*

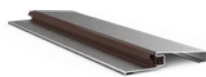

WITH SEAL
HEIGHT 19 mm

LAMINATED / INOX*

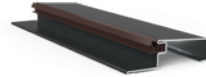

WITH SEAL
HEIGHT 32 mm

NORWEGIAN WOODEN* (brown, light brown, light)



WITH SEAL
HEIGHT 19 mm

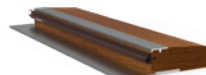

WITH ALUMINUM STRIP
AND SEAL, HEIGHT 28 mm

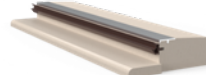

WITH WOODEN STRIP
AND SEAL, HEIGHT 35 mm

* EXTRA CHARGE

FITTINGS

RC2
RC3

BERGEN TW300

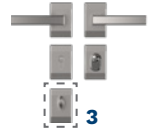

RC2

RC3

BERGEN TD200 BERGEN TD300



RC2

BLOK TW200



RC2

RC3

BLOK TD200 BLOK TD300



RC2

OSLO

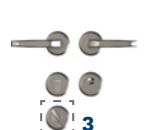

FITTINGS COLOUR
BERGEN, BLOK

PLATINUM ANODE



SILVER ANODE



BLACK ANODE



FITTINGS COLOUR
OSLO

SATIN NICKEL







- 1 upper escutcheon without lock cylinder protection
- 2 upper escutcheon with lock cylinder protection*
- 3 rigid chain*



Gerda ENJOY doors are anti-burglary doors dedicated for use inside the buildings as front door to residential apartments. Construction of the Gerda ENJOY door leaf is based on the frame made of an MDF profile reinforced with a steel flat bar and filled with an acoustic package made of natural composite panel. The use of acoustic filling results in increased sound reduction index of 32 dB. Construction of Gerda ENJOY door leaf is covered on both sides with MDF panels. Gerda ENJOY door is equipped with a double set of chamber sealing along the perimeter of the door leaf, the frame and the threshold to ensure good parameters of insulation. The door leaf and the frame are covered with Finish foil with wood-like pattern imitating natural wood grain.

PARAMETERS

	ANTI-BURGLARY PROTECTION CLASS	RC1N
	LEAF THICKNESS	46 mm
	SOUND REDUCTION INDEX	32 dB
	DOOR SIZES	80, 90
	FILLING	SOUNDPROOFING PACKAGE

RC1N

GERDA[®]
ENJOY



DOOR LEAF WITH SEAL



WOODEN DOOR FRAME WITH SEAL

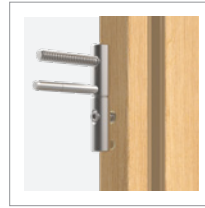

3D HINGES

Adjustable in three planes, 4 pcs.



DOOR THICKNESS

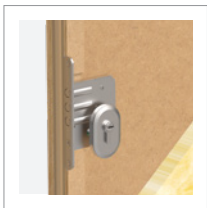

ADDITIONAL LOCK

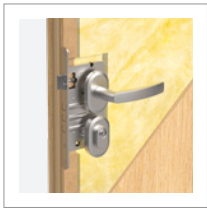

MAIN LOCK



ADJUSTABLE LATCH CATCH

Allows seamless adjustment of the door leaf pressure against the gaskets.



3 FIXED BOLTS

Fixed bolts in metal supports protecting against forcing the door.



ALUMINIUM THRESHOLD WITH SEAL

WOODEN FRAME



ALUMINIUM THRESHOLD

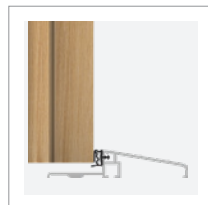

ACOUSTIC FILLING



SINGLE KEY SYSTEM

Black colour not available for class 2 cylinders



W00 FDG MOUNTAIN OAK



W00 INSIDE

SIZE	80	90
-------------	----	----

MODEL	ENJOY
--------------	--------------

W00 PLAIN

RC1N STANDARD ELEMENTS

ENJOY DOOR LEAF (30 dB WITH SEAL)	FITTINGS SET WITH MAIN LOCK CYLINDER PROTECTION
WOODEN DOOR FRAME WITH SEAL	BLOK TW200 SPLIT ESCUTCHEON + HANDLES
ADJUSTABLE 3D HINGES	CLASS 2 LOCK CYLINDERS IN SINGLE KEY SYSTEM
ALUMINUM THRESHOLD WITH SEAL 19 mm	

EXTRA CHARGES

DOOR SHORTENING (30, 50, 70 mm)	WIDE-ANGLE VIEWER
UPPER ESCUTCHEON PROTECTION	2.4" ELECTRONIC VIEWER
CLASS 5 LOCK CYLINDERS IN SINGLE KEY SYSTEM	4.3" ELECTRONIC VIEWER
CLASS 6 LOCK CYLINDERS IN SINGLE KEY SYSTEM	TEDEE SET

DOOR COLOURS

NORTH WALNUT

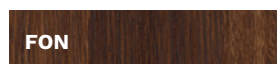

FON

MOUNTAIN OAK



FDG

GREY OAK



FDS

SILVER



FSI

SONOMA



FSS

COMFORT AND SAFETY AT AN AFFORDABLE PRICE

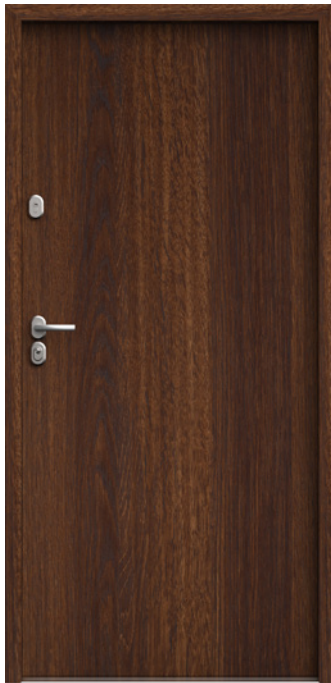

W00 FON WALNUT NORTH



W00 FDS GREY OAK



W00 FSI SILVER



W00 FSS SONOMA

FITTINGS

BLOK TW200



ALUMINIUM THRESHOLD



WOODEN DOOR FRAME



FITTINGS COLOUR

PLATINUM ANODE



SILVER ANODE



BLACK ANODE



1 upper escutcheon without cylinder protection
2 upper escutcheon with cylinder protection*

DOOR COLOURS

NORTH WALNUT

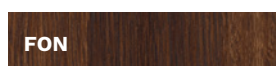

MOUNTAIN OAK



GREY OAK



SILVER



SONOMA



* EXTRA CHARGE

PORTALS AND DOOR TRIMS

GERDA®

BRING OUT THE ELEGANCE OF YOUR DOOR

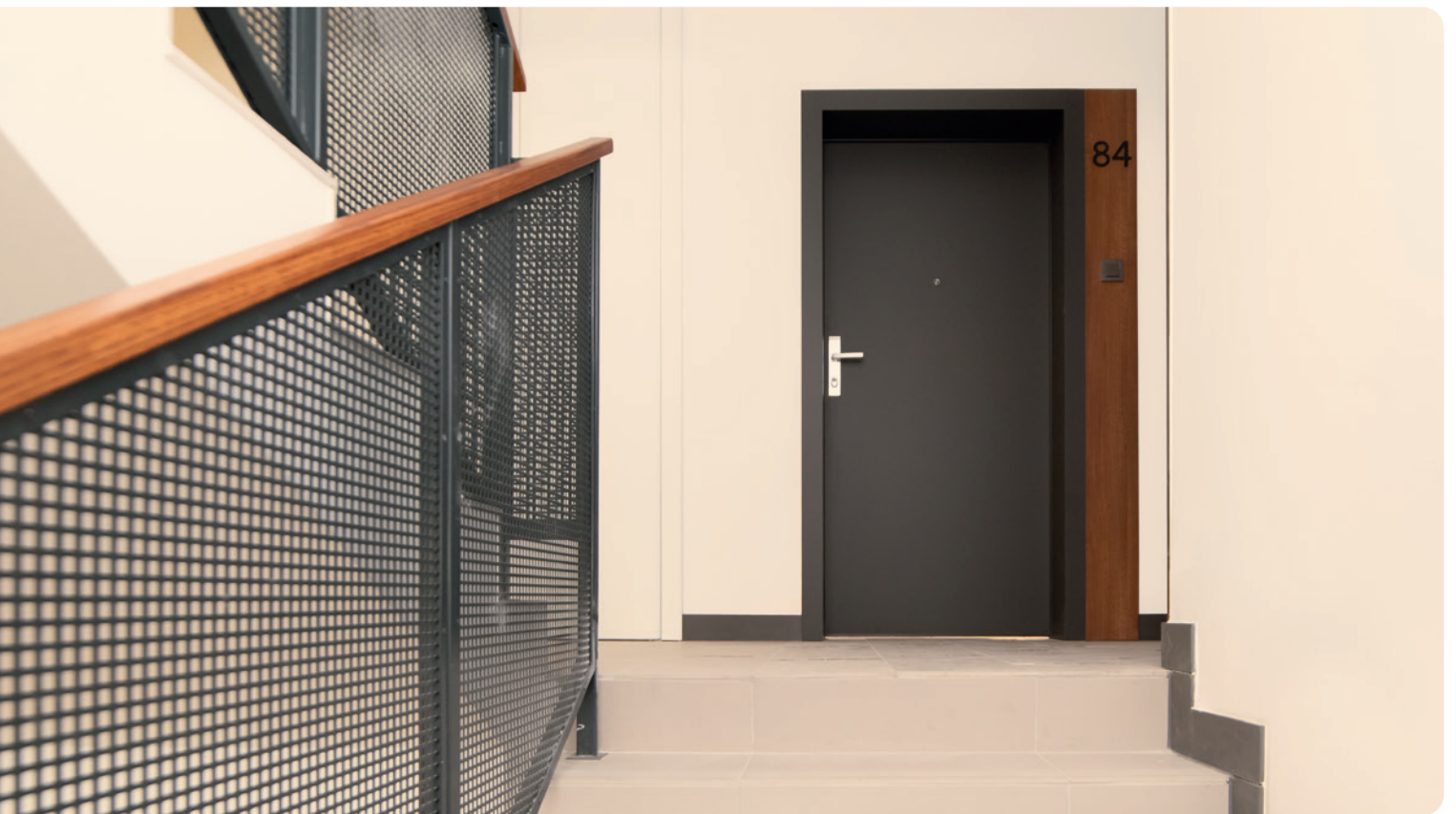

Door trim (2400 x 80 x 12 mm) – available only with FA door frame.

DOOR TRIMS*

This element improves the appearance of the entrance to the apartment. It makes your door stand out among regular doors. It can be applied in GERDA metal doors and with ELITE package in sizes 80N, 80, 90, 90Z, 100E. They are available in sets for one or both door sides.

DOOR PORTALS*

This is a special type of door trim, used in the specific frame casing that visibly brings out the elegance of the door. Much like the door trims, the door portal can be used in GERDA metal doors and with ELITE package in sizes 80N, 80, 90, 90Z, 100E. The decision to purchase door portals should be made already when ordering a door, because they are fixed to special frames available at an extra charge.



COLOUR PALETTE

ALPINE
WALNUT

FRR

BRAZILIAN
WALNUT

FRB

LIGHT
WALNUT

FRP

GOLDEN OAK

FDE

WINCHESTER

FDW

LIGHT
WENGE

FEJ

WHITENED
WENGE

FBJ

WHITE

FSB

STEEL GREY

FKZ



DOOR PORTAL*

Add up each of the parts **L** – left, **P** – right and **W** – top, to get the total price for the portal. Thickness of the portal is 18 mm for dimension **G** and 12 mm for dimension **L, P, W**. The overall width of the compound is the sum of the widths of the door (outer frame dimension) and width of the right and the left side of the portal. Similarly, the height of the compound is the sum of the door height with frame and the height of the top side of the portal. NRO board (that does not spread fire) +40% to the given prices.

Wall lining in mm	L	P	W
50 - 100	✓	✓	✓
110 - 150	✓	✓	✓
160 - 200	✓	✓	✓
210 - 250	✓	✓	✓
260 - 300	✓	✓	✓
310 - 350	✓	✓	✓
360 - 400	✓	✓	✓
410 - 450	-	-	✓
460 - 500	-	-	✓
510 - 550	-	-	✓
560 - 600	-	-	✓
NRO (fire resistant board)	+40% extra charge to the set		

Portal depth G in mm stroke every 5 mm		FA door frame with groove in mm	Wall thickness in mm		Portal depth G in mm stroke every 5 mm		FT door frame with groove in mm for metal doors/ elite package	Wall thickness in mm	
from 50	to 400	80	from 130	to 480	from 50	to 400	70/75	from 120/125	to 470/475

GREY	DARK BROWN	ANTHRACITE	DARK ANTHRACITE	BLACK	SILICON	MARBLE	HAEMATITE	QUARTZ	WENGE
FKT	FKX	FKG	FKF	FKC	FKL	FKA	FDG	FKH	FEE

PORTALS AND DOOR TRIMS

GERDA®

BRING OUT THE ELEGANCE OF YOUR DOOR

FA PORTAL*

ASYMMETRICAL FRAME WITH SEAL AND GROOVE FOR PORTAL OR TRIM

F = 80 mm

HORIZONTAL CROSS-SECTION

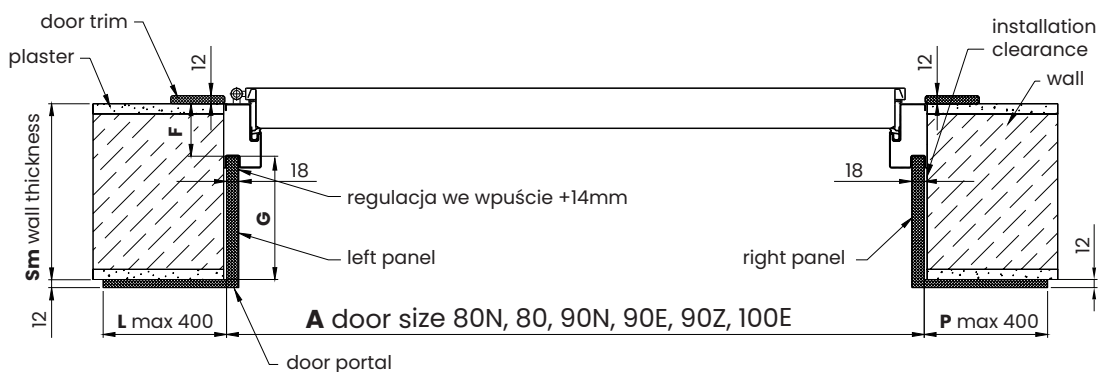

VERTICAL CROSS-SECTION

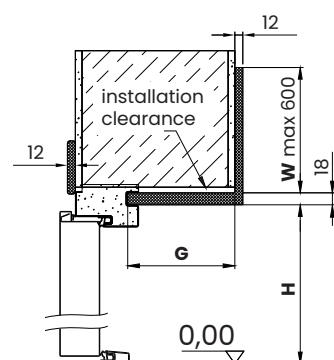

FT PORTAL*

CORNER FRAME WITH SEAL AND GROOVE FOR PORTAL OR TRIM

F = 70 mm – metal doors

F = 75 mm – doors with ELITE package

HORIZONTAL CROSS-SECTION

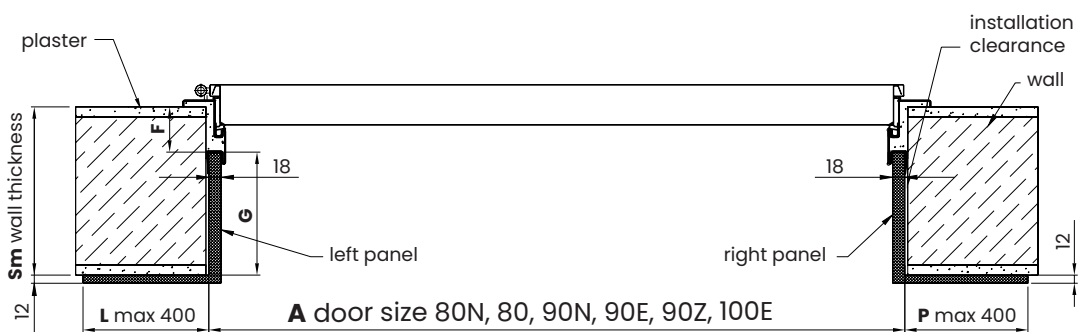

VERTICAL CROSS-SECTION

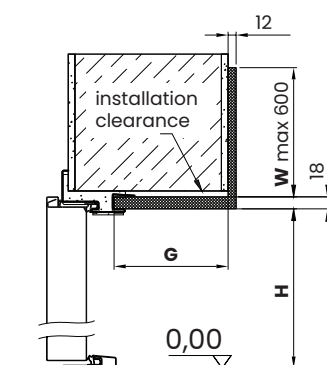

LEGEND

- G** - portal depth (mm)
- L** - width of the left lining (mm)
- P** - width of the right lining (mm)
- F** - diameter from the edge of the wall till the bottom of the groove

G = Sm - F (mm)

- W** - height of portal's vertical beam (mm)
- H** - height of portal's vertical beam (mm)

For std height:
 FT = 2030 mm, FA = 2058 mm
A - door size: 80N, 80, 90N, 90E, 90Z, 100E
Sm - wall thickness (mm)

CAUTION! Dimensions on the inside of the portal measured from the edge of the wall do not include the thickness of the material.

FTM7 / FTM8 PORTAL*

CORNER FRAME WITH SEAL AND GROOVE FOR STEEL TRIM

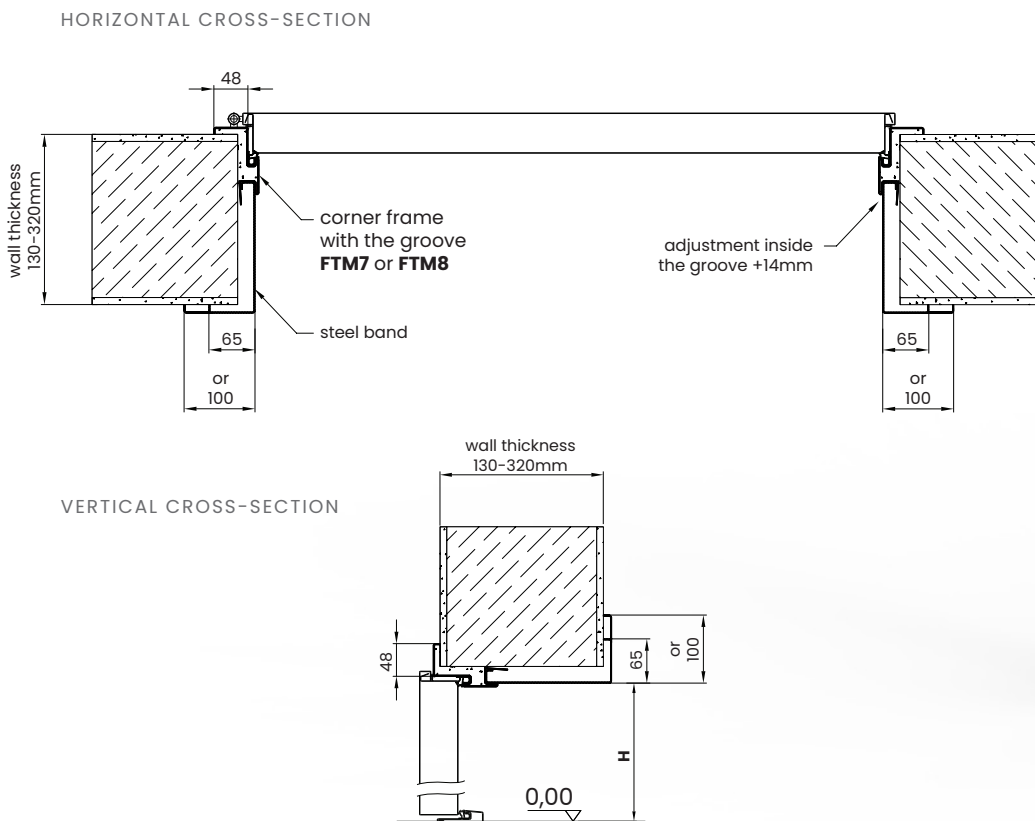

DOOR FRAME	DOOR MODEL	WALL THICKNESS (in mm) Stroke every 10 mm	WALL LINING IN mm
FTM7	Comfort RC2 / RC3 Premium RC2 / RC3	130 - 230	65
FTM7	Comfort RC2 / RC3 Premium RC2 / RC3	240 - 300	65
FTM7	Comfort RC2 / RC3 Premium RC2 / RC3	310 - 320	65
FTM7	Comfort RC2 / RC3 Premium RC2 / RC3	130 - 230	100
FTM7	Comfort RC2 / RC3 Premium RC2 / RC3	240 - 300	100
FTM7	Comfort RC2 / RC3 Premium RC2 / RC3	310 - 320	100
FTM8	Premium RC2 / RC3 EI30 / EI45 / EI60	130 - 230	65
FTM8	Premium RC2 / RC3 EI30 / EI45 / EI60	240 - 300	65
FTM8	Premium RC2 / RC3 EI30 / EI45 / EI60	310 - 320	65
FTM8	Premium RC2 / RC3 EI30 / EI45 / EI60	130 - 230	100
FTM8	Premium RC2 / RC3 EI30 / EI45 / EI60	240 - 300	100
FTM8	Premium RC2 / RC3 EI30 / EI45 / EI60	310 - 320	100

ACCESSORIES AND FITTINGS

GERDA®

LIST OF ELEMENTS

HANDLES / KNOBS

			ENJOY	COMFORT	PREMIUM	PREMIUM EI30 EI45 EI60	STAR
	BERGEN (handle - handle) TD200	RC2	—	✓	✓	✓	—
	BERGEN (handle - handle) TD300	RC3	—	✓	✓	—	—
	BERGEN (handle - handle) TD1000	RC4	—	—	✓	✓	—
	BERGEN (knob - handle) TD200	RC2	—	✓	✓	✓	—
	BERGEN (knob - handle) TD300	RC3	—	✓	✓	—	—
	BERGEN (knob - handle) TD1000	RC4	—	—	✓	✓	—
	BERGEN (handle - handle)		—	✓	✓	✓	—
	BLOK (handle - handle) TD200	RC2	—	✓	✓	✓	—
	BLOK (handle - handle) TD300	RC3	—	✓	✓	—	—
	BLOK (handle - handle) TD1000	RC4	—	—	✓	✓	—
	BLOK (knob - handle) TD200	RC2	—	✓	✓	✓	—
	BLOK (knob - handle) TD300	RC3	—	✓	✓	—	—
	BLOK (knob - handle) TD1000	RC4	—	—	✓	✓	—
	BLOK (handle - handle)		✓	✓	✓	✓	—
	OSLO (handle - handle)		—	✓	✓	—	—
	TECHNO (handle - handle)		—	—	—	—	✓
	TECHNO (knob - handle)		—	—	—	—	✓

SPLIT ESCUTCHEONS

			ENJOY	COMFORT	PREMIUM	PREMIUM EI30 EI45 EI60	STAR
	BERGEN TW300 split escutcheon with cylinder protection	RC2 RC3	—	✓	✓	✓	—
	BERGEN split escutcheon without cylinder protection		—	✓	✓	—	—
	BLOK TW1000 split escutcheon with cylinder protection	RC4	—	✓	✓	✓	—
	BLOK TW200 split escutcheon with cylinder protection	RC2	✓	✓	✓	✓	—
	BLOK split escutcheon without cylinder protection		✓	✓	✓	—	—
	OSLO split escutcheon with cylinder protection	RC2	—	✓	✓	—	✓
	OSLO split escutcheon without cylinder protection		—	✓	✓	—	—
	rigid chain		—	✓	✓	—	✓

MORTISE LOCKS

			ENJOY	COMFORT	PREMIUM	PREMIUM EI30 EI45 EI60	STAR
	ZW 250 (additional)		✓	—	—	—	—
	ZW 400 (main)	class 2	✓	—	—	—	—
	ZW 500 Premium (additional)	class 6	—	✓	✓	✓	—
	ZW 1000 ZM Premium (main)	class 7	—	✓	✓	✓	—
	ZW 2000 ZM Premium (main)	class 6	—	✓	✓	✓	—
	ZW 3000 ZPS Premium (main)	class 7	—	✓	✓	✓	—
	ZW 6000 Premium (main)	class 6	—	—	—	—	✓
	zamek Premium (auxiliary)		—	✓	✓	✓	✓

ACCESSORIES	ENJOY	COMFORT	PREMIUM	PREMIUM			STAR
				EI30	EI45	EI60	
 WIDE-ANGLE VIEWER 50/85	✓	✓	✓	✓	✓	✓	✓
 2.4" ELECTRONIC VIEWER	✓	✓	✓	✓	✓	✓	✓
 4.3" ELECTRONIC VIEWER	✓	✓	✓	✓	✓	✓	✓
 HINGE CAPS FI 18 mm	—	—	—	—	—	—	✓
 3D HINGE CAPS FI 16 mm	—	✓	✓	✓	✓	✓	—
	GEZE DOOR CLOSER GT 1500 STANDARD	—	✓	✓	✓	✓	✓
	GEZE DOOR CLOSER GT 1500 LOCK	—	✓	✓	✓	✓	✓
	GEZE DOOR CLOSER GT 3000 STANDARD	—	✓	✓	✓	✓	✓
	GEZE DOOR CLOSER GT 3000 LOCK	—	✓	✓	✓	✓	✓
 LAMINATED THRESHOLD 19 mm / 32 mm (MATCHING THE COLOUR OF DOOR FRAME)	—	✓	✓	✓	✓	✓	✓
	INOX THRESHOLD 19 mm	—	✓	✓	✓	✓	✓
	INOX THRESHOLD 32 mm	—	✓	✓	—	—	✓
 19 mm NORWEGIAN WOODEN THRESHOLD WITH SEAL AND ALUMINIUM COVER, AVAILABLE IN 3 COLOURS (BRONZE, LIGHT BRONZE, LIGHT)	—	✓	✓	✓	✓	✓	✓
 28 mm NORWEGIAN WOODEN THRESHOLD WITH SEAL, ALUMINIUM COVER AND STRIP, AVAILABLE IN 3 COLOURS (BRONZE, LIGHT BRONZE, LIGHT)	—	✓	✓	✓	✓	✓	✓
 35 mm NORWEGIAN WOODEN THRESHOLD WITH SEAL, ALUMINIUM COVER AND WOODEN STRIP AVAILABLE IN 3 COLOURS (BRONZE, LIGHT BRONZE, LIGHT)	—	✓	✓	—	—	—	✓

ACCESSORIES AND FITTINGS

GERDA®

LIST OF ELEMENTS

ACCESSORIES			ENJOY	COMFORT	PREMIUM	PREMIUM			STAR
						EI30	EI45	EI60	
	FAIL-SECURE ELECTRIC DOOR STRIKE NC (NO VOLTAGE – CLOSED)	RC2 RC3 RC4	–	✓	✓	–	–	–	✓
	FAIL-SECURE FIRE-RESISTANT ELECTRIC DOOR STRIKE NC (NO VOLTAGE – CLOSED)	RC2 RC3 RC4	–	–	–	✓	–	–	–
	FAIL-SECURE ELECTRIC DOOR STRIKE NO (NO VOLTAGE – OPEN)	RC2 RC3 RC4	–	✓	✓	–	–	–	✓
	FAIL-SECURE ELECTRIC DOOR STRIKE NC (REED SWITCH INTEGRATED)	RC2 RC3 RC4	–	✓	✓	–	–	–	✓
	FAIL-SECURE FIRE-RESISTANT ELECTRIC DOOR STRIKE NC (REED SWITCH INTEGRATED)	RC2 RC3 RC4	–	–	–	✓	–	–	–
	LAMINATED CLOSURE DOOR TRIM*		–	✓	✓	✓	✓	✓	✓
	NUMERIC KEYPAD FOR ACCESS CONTROL		–	✓	✓	✓	✓	✓	✓
	tedee NUMERIC KEYPAD FOR ACCESS CONTROL		–	✓	✓	✓	✓	✓	✓
	IMPULSE POWER SUPPLY PSC12015 RECOMMENDED FOR DOORS EQUIPPED WITH AN ELECTRIC STRIKE		–	✓	✓	✓	✓	✓	✓
	MORTAR VARNISH 12 ml		✓	✓	✓	✓	✓	✓	✓
	CYLINDER MAINTENANCE PREPARATION 25 ml		✓	✓	✓	✓	✓	✓	✓
	CYLINDER MAINTENANCE PREPARATION 100 ml		✓	✓	✓	✓	✓	✓	✓
	CYLINDER MAINTENANCE PREPARATION 400 ml		✓	✓	✓	✓	✓	✓	✓
	DOOR MAINTENANCE PREPARATION		✓	✓	✓	✓	✓	✓	✓

*LAMINATED CLOSURE DOOR TRIM – Necessary when self-shortening the leaf in the range 20, 30, 40, 50, 60, 70 and 20.35 mm and 20 and 35 mm for RC4. Not available for fire-resistant and ELITE package doors.

ENJOY

DOOR OPENING DIRECTION	MAIN LOCK CYLINDER SIZE	ADDITIONAL LOCK CYLINDER SIZE	NUMBER OF KEYS	CYLINDER CLASS
to the inside of the apartment	28/45 cam	G45/28 cam	6 end user's keys	class 2
	30/45 cam	G45/30 cam	5 + installer's keys	class 5
	30/45 cam	G45/30 cam	5 + installer's keys	class 6
to the outside of the apartment (to the corridor)	28/45 cam	G28/45 cam	6 end user's keys	class 2
	30/45 cam	G30/45 cam	5 + installer's keys	class 5
	30/45 cam	G30/45 cam	5 + installer's keys	class 6

COMFORT 60 / PREMIUM 60

DOOR OPENING DIRECTION	MAIN LOCK CYLINDER SIZE	ADDITIONAL LOCK CYLINDER SIZE	NUMBER OF KEYS	CYLINDER CLASS
to the inside of the apartment	35/55 cog wheel cam	G55/35 cam	5 + installer's keys	class 5
	35/55 cog wheel cam	G55/35 cam	5 + installer's keys	class 6
to the outside of the apartment (to the corridor)	35/55 cog wheel cam	G35/55 cam	5 + installer's keys	class 5
	35/55 cog wheel cam	G35/55 cam	5 + installer's keys	class 6

PREMIUM 60X PAKIET ELITE

DOOR OPENING DIRECTION	MAIN LOCK CYLINDER SIZE	ADDITIONAL LOCK CYLINDER SIZE	NUMBER OF KEYS	CYLINDER CLASS
to the inside of the apartment	40/60 cog wheel cam	G60/40 cam	5 + installer's keys	class 5
	40/60 cog wheel cam	G60/40 cam	5 + installer's keys	class 6
to the outside of the apartment (to the corridor)	40/60 cog wheel cam	G40/60 cam	5 + installer's keys	class 5
	40/60 cog wheel cam	G40/60 cam	5 + installer's keys	class 6

STAR 60

DOOR OPENING DIRECTION	MAIN LOCK CYLINDER SIZE	ADDITIONAL LOCK CYLINDER SIZE	NUMBER OF KEYS	CYLINDER CLASS
universal	RIM6000	-	5 end user's keys	class 6
to the inside of the apartment	-	G55/35 cam	5 + installer's keys	class 5
to the outside of the apartment (to the corridor)	-	G35/55 cam	5 + installer's keys	class 6

STAR 60X PAKIET ELITE

DOOR OPENING DIRECTION	MAIN LOCK CYLINDER SIZE	ADDITIONAL LOCK CYLINDER SIZE	NUMBER OF KEYS	CYLINDER CLASS
universal	RIM6000	-	5 end user's keys	class 6
to the inside of the apartment	-	G60/40 cam	5 + installer's keys	class 5
to the outside of the apartment (to the corridor)	-	G40/60 cam	5 + installer's keys	class 6

DOOR COLOURS

GERDA®

CHOOSE A COLOUR FOR YOUR METAL DOOR AND ELITE PACKAGE

DOOR COLOURS INCLUDING PANELS, MOULDING AND FRAMES OF THE ELITE PACKAGE

ALPINE WALNUT

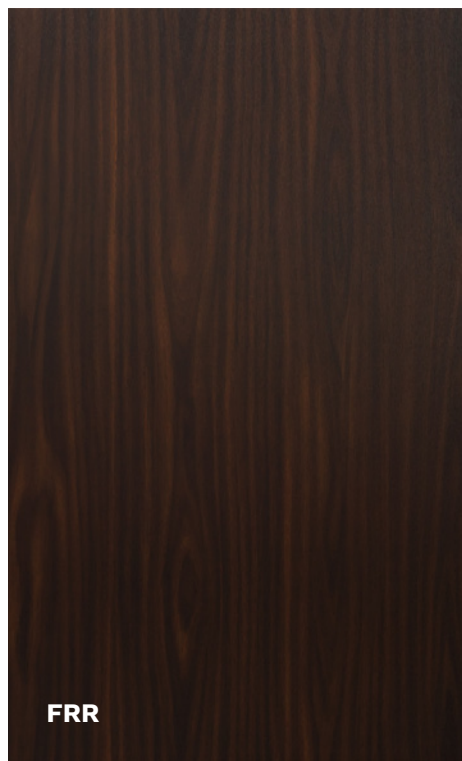

BRAZILIAN WALNUT

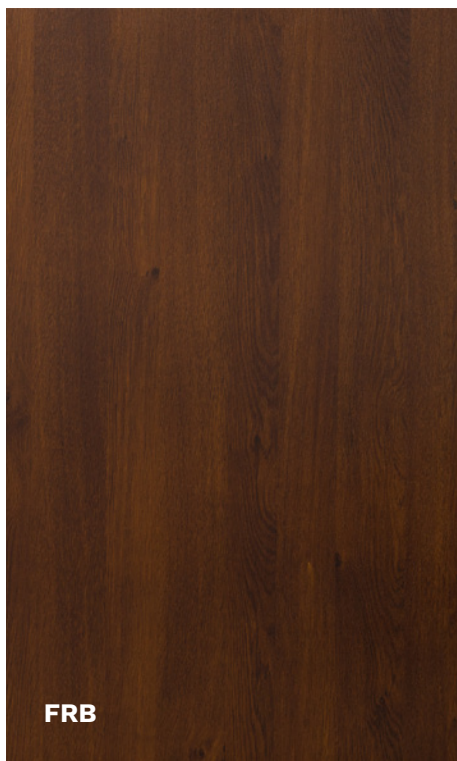

LIGHT WALNUT



WHITENED WENGE



WHITE

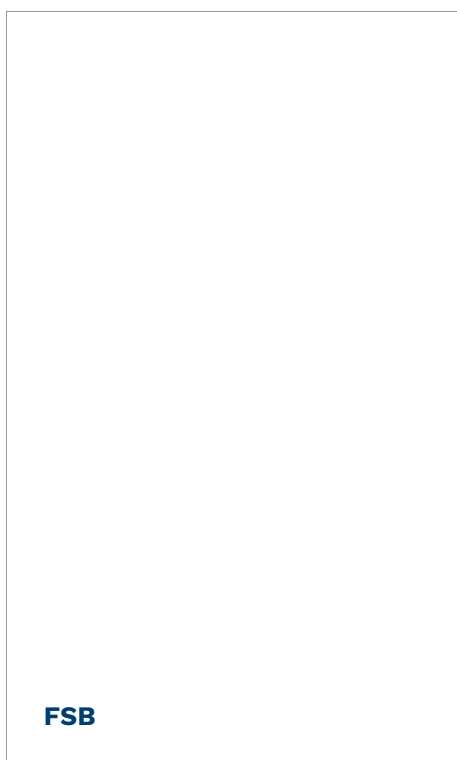

STEEL GREY

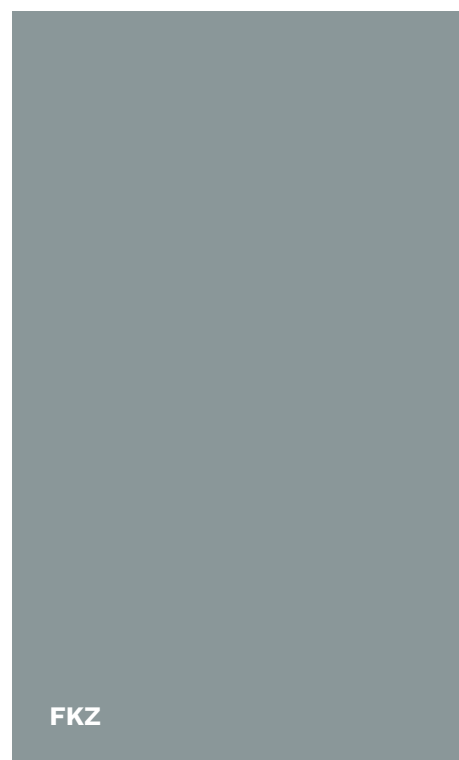

CHOOSE A COLOUR FOR YOUR METAL DOOR AND ELITE PACKAGE

DOOR COLOURS INCLUDING PANELS, MOULDING AND FRAMES OF THE ELITE PACKAGE

GOLDEN OAK

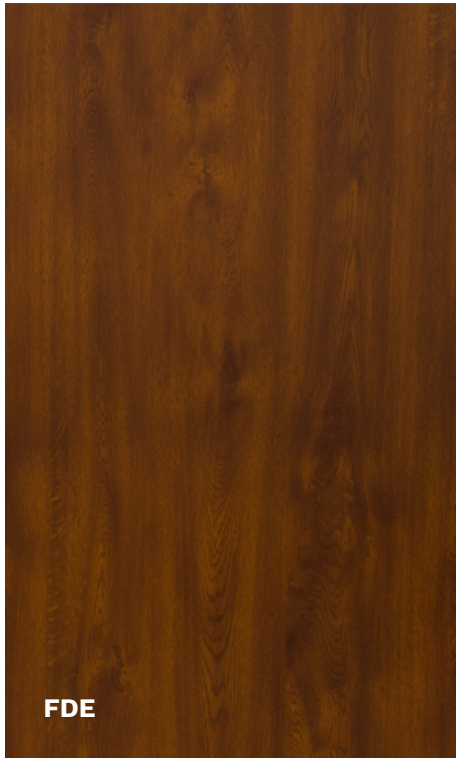

WINCHESTER



LIGHT WENGE



ANTHRACITE

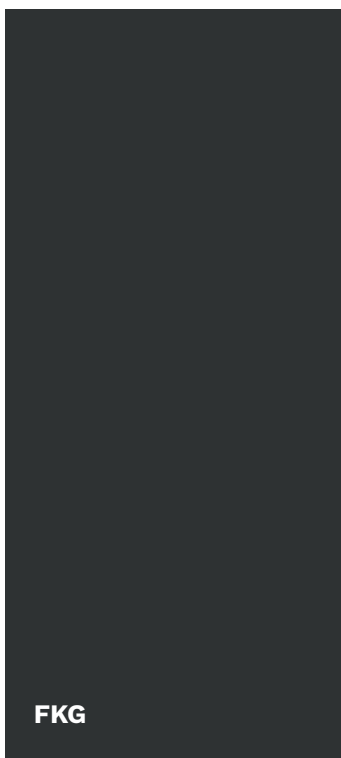

DARK ANTHRACITE



BLACK

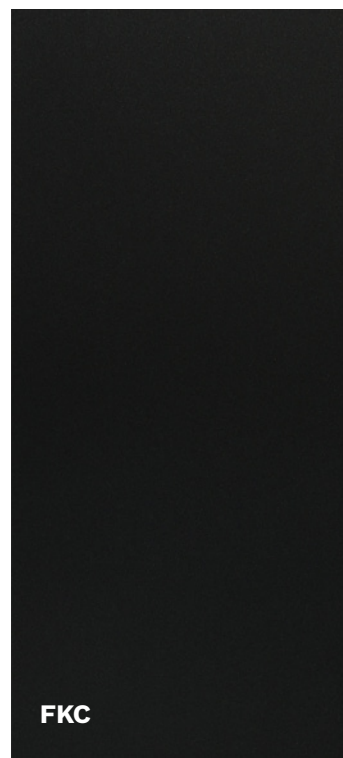

TURNER OAK



A VARIETY OF COLOURS

GERDA®

CHOOSE A COLOUR FOR YOUR METAL DOOR AND ELITE PACKAGE

ELITE PACKAGE

SILICON



MARBLE

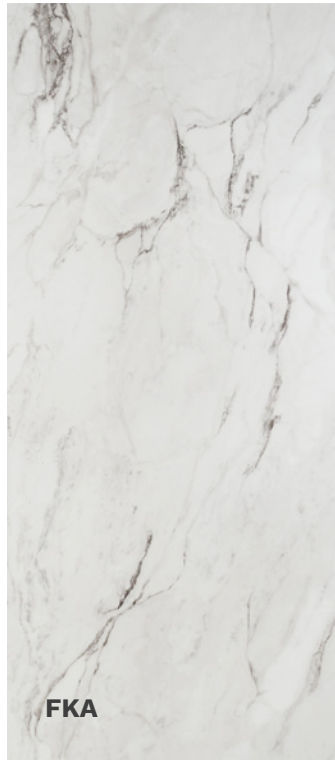

HAEMATITE



QUARTZ



MOULDING AND FRAMES OF ELITE PACKAGE

WENGE



WENGE

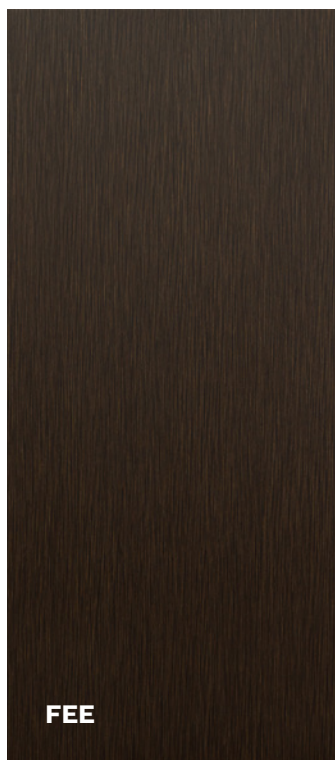

DARK BROWN

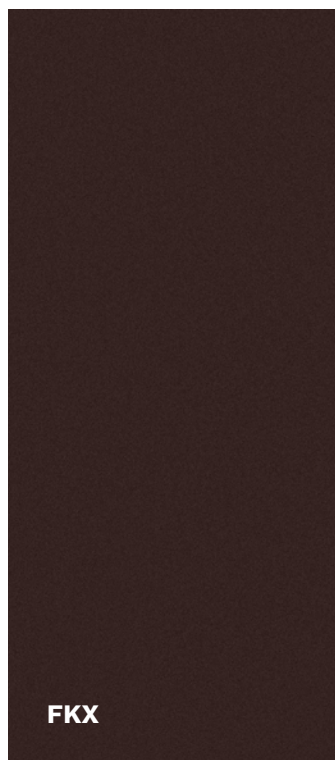

GREY



ENJOY DOORS

NORTH WALNUT



MOUNTAIN OAK



GREY OAK



SILVER



SONOMA



DOOR AND FRAME DIMENSIONS



ADDITIONAL INFORMATION FOR ASSEMBLY

COMFORT 60 DOOR LEAF DIMENSIONS

	METAL DOORS			
SIZE	A	B	C	D
80N	783	813	2025	2040
80	813	843		
90N	883	913		
90E*	926	956		
90Z**	946	976		
100E	1026	1056		

COMFORT 60 DOOR FRAME DIMENSIONS

WKO MOUNTING SYSTEM (ANCHOR+BRACKET)

	FD SYMMETRICAL DOOR FRAME WITHOUT SEAL						ASSEMBLY HOLE	
SIZE	J	K	L	M	N	O	X	Y
80N	764	872	-	2005	2078	-	902	2093
80	794	902	-			-	932	
90N	864	972	-			-	1002	
90Z	927	1035	-			-	1065	
100E	1007	1115	-			-	1145	

	FN CORNER DOOR FRAME WITHOUT SEAL						ASSEMBLY HOLE	
SIZE	J	K	L	M	N	O	X	Y
80N	764	798	872	2005	2041	2078	829 / 847 ¹	2056
80	794	828	902				859 / 877 ¹	
90N	864	898	972				929 / 947 ¹	
90Z	927	961	1035				992 / 1010 ¹	
100E	1007	1041	1115				1072 / 1090 ¹	

* 90E - size available only for STAR 60 doors

** 90Z - size available only for COMFORT 60 and PREMIUM 60 doors

¹ - dimension of raw installation hole including clearance for deadbolts and fixed bolts caps

DOOR OPENING DIRECTIONS

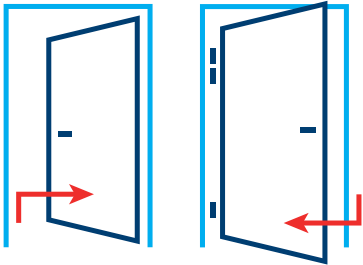

LEFT

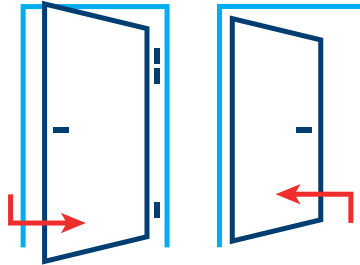

RIGHT

COMFORT 60 DOORS TECHNICAL DRAWINGS WKO MOUNTING SYSTEM (ANCHOR+BRACKET)

FD SYMMETRICAL DOOR FRAME WITHOUT SEAL

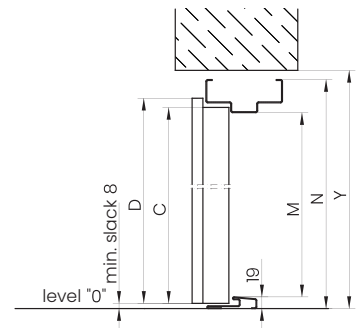
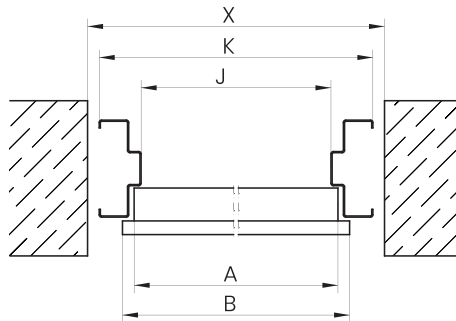
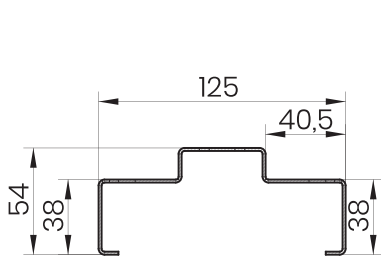

FN CORNER DOOR FRAME WITHOUT SEAL

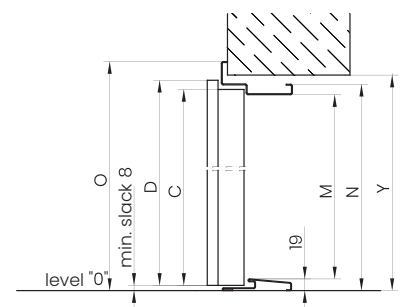
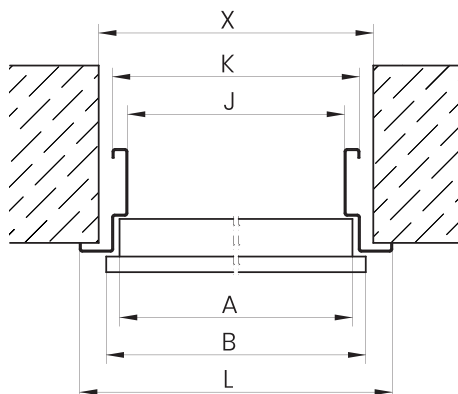
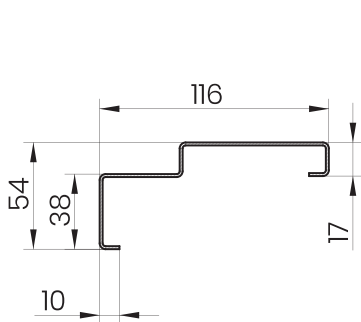

DOOR AND FRAME DIMENSIONS



ADDITIONAL INFORMATION FOR ASSEMBLY

STAR 60, PREMIUM 60, COMFORT 60 DOOR LEAF DIMENSIONS

WKO MOUNTING SYSTEM (ANCHOR+BRACKET)

SIZE	METAL DOORS				PANEL DOORS			
	A	B	C	D	A	B	C	D
80N	783	813	2025	2040	786	816	2025	2040
80	813	843			816	846		
90N	883	913			885	915		
90E*	926	956			929	959		
90Z**	946	976			949	979		
100E	1026	1056			1029	1059		

STAR 60, PREMIUM 60, COMFORT 60 DOOR FRAME DIMENSIONS

WKO MOUNTING SYSTEM (ANCHOR+BRACKET)

SIZE	FA ASYMMETRICAL DOOR FRAME WITH SEAL							ASSEMBLY HOLE				
	J	J***	K	K***	L	L***	M	N	O	X	X***	Y
80N	765	761	872	868	-	-	2005	2078	-	902	898	2093
80	795	791	902	898	-	-				932	928	
90N	865	861	972	968	-	-				1002	998	
90E*	908	-	1015	-	-	-				1045	-	
90Z**	928	924	1035	1031	-	-				1065	1061	
100E	1008	1004	1115	1111	-	-				1145	1141	

SIZE	FT CORNER DOOR FRAME WITH SEAL							ASSEMBLY HOLE				
	J	J***	K	K***	L	L***	M	N	O	X	X***	Y
80N	765	761	799	795	872	868	2005	2041	2078	829/847 ¹	825/843 ¹	2057
80	795	791	829	825	902	898				859/877 ¹	855/873 ¹	
90N	865	861	899	895	972	968				929/947 ¹	925/943 ¹	
90E*	908	-	942	-	1015	-				972/990 ¹	-	
90Z**	928	924	962	958	1035	1031				992/1010 ¹	988/1006 ¹	
100E	1008	1004	1042	1038	1115	1111				1072/1090 ¹	1068/1086 ¹	

* 90E - size available only for STAR 60 doors

** 90Z - size available only for COMFORT 60 and PREMIUM 60 doors

*** for E130 metal doors

1 - dimension of raw installation hole including clearance for deadbolts and fixed bolts caps

DOOR OPENING DIRECTIONS

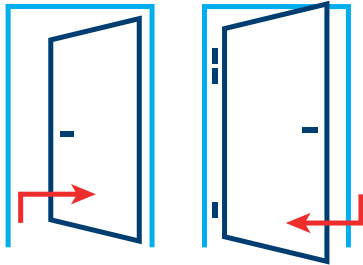

LEFT

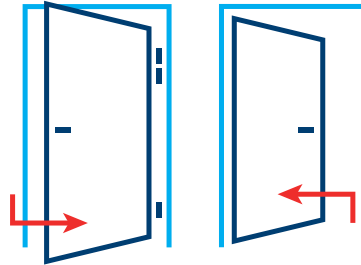

RIGHT

STAR 60, PREMIUM 60, COMFORT 60 DOORS TECHNICAL DRAWINGS WKO MOUNTING SYSTEM (ANCHOR+BRACKET)

FA ASYMMETRICAL DOOR FRAME WITH SEAL

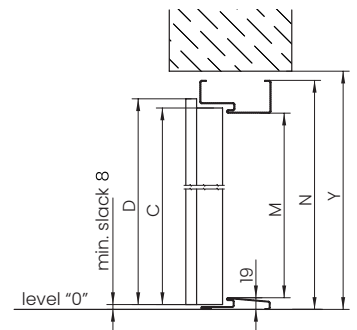
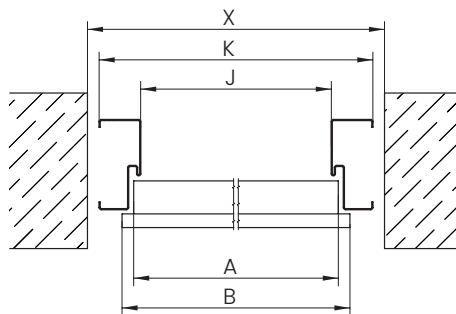
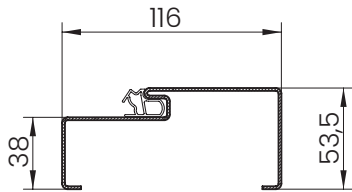

FT CORNER DOOR FRAME WITH SEAL

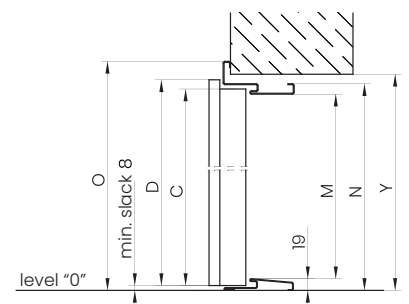
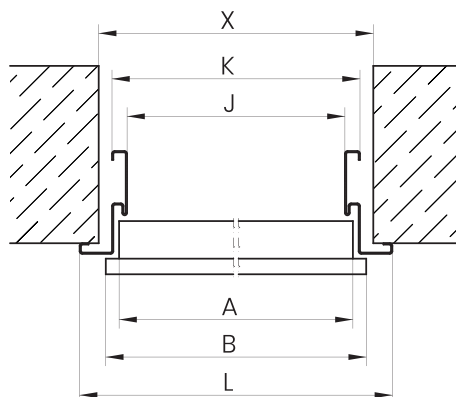
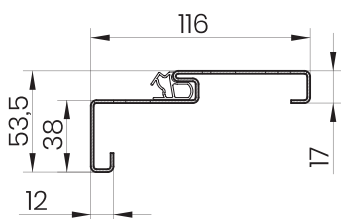

DOOR AND FRAME DIMENSIONS



ADDITIONAL INFORMATION FOR ASSEMBLY

STAR 60, PREMIUM 60, COMFORT 60 DOOR LEAF DIMENSIONS

SIZE	METAL DOORS				PANEL DOORS			
	A	B	C	D	A	B	C	D
80N	783	813	2025	2040	786	816	2025	2040
80	813	843			816	846		
90N	883	913			885	915		
90E*	926	956			929	959		
90Z**	946	976			949	979		
100E	1026	1056			1029	1059		

STAR 60, PREMIUM 60, COMFORT 60 DOOR FRAME DIMENSIONS

WKO MOUNTING SYSTEM (ANCHOR+BRACKET)

SIZE	FA PORTAL ASYMMETRICAL DOOR FRAME WITH GROOVE AND SEAL										ASSEMBLY HOLE		
	J	J***	K	K***	L	L***	M	N	O	U	X	X***	Y
80N	765	761	872	868	-	-	2005	2078	-	95	902	898	2093
80	795	791	902	898	-	-					932	928	
90N	865	861	972	968	-	-					1002	998	
90E*	908	-	1015	-	-	-					1045	-	
90Z**	928	924	1035	1031	-	-					1065	1061	
100E	1008	1004	1115	1111	-	-					1145	1141	

SIZE	FT PORTAL CORNER DOOR FRAME WITH GROOVE AND SEAL											ASSEMBLY HOLE		
	J	J***	K	K***	L	L***	M	N	O	U ¹	U ²	X	X***	Y
80N	765	761	821	817	892	888	2005	2052	2088	95 ¹	101 ²	857	853	2070
80	795	791	851	847	922	918						887	883	
90N	865	861	921	917	992	988						957	953	
90E*	908	-	964	-	1035	-						1000	-	
90Z**	928	924	984	980	1055	1051						1020	1016	
100E	1008	1004	1064	1060	1135	1131						1100	1096	

* 90E - size available only for STAR 60 doors

** 90Z - size available only for COMFORT 60 and PREMIUM 60 doors

*** for FR (fire resistant) metal doors

1 - dimensions of metal doors

2 - dimensions of panel doors

DOOR OPENING DIRECTIONS

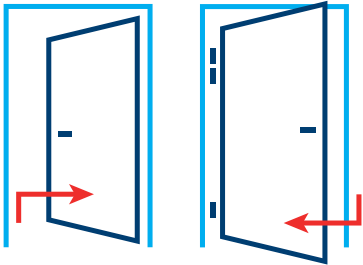

LEFT

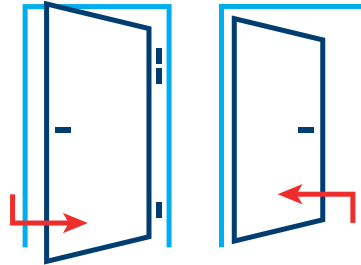

RIGHT

STAR 60, PREMIUM 60, COMFORT 60 DOORS TECHNICAL DRAWINGS WKO MOUNTING SYSTEM (ANCHOR+BRACKET)

FA PORTAL

ASYMMETRICAL DOOR FRAME WITH GROOVE AND SEAL

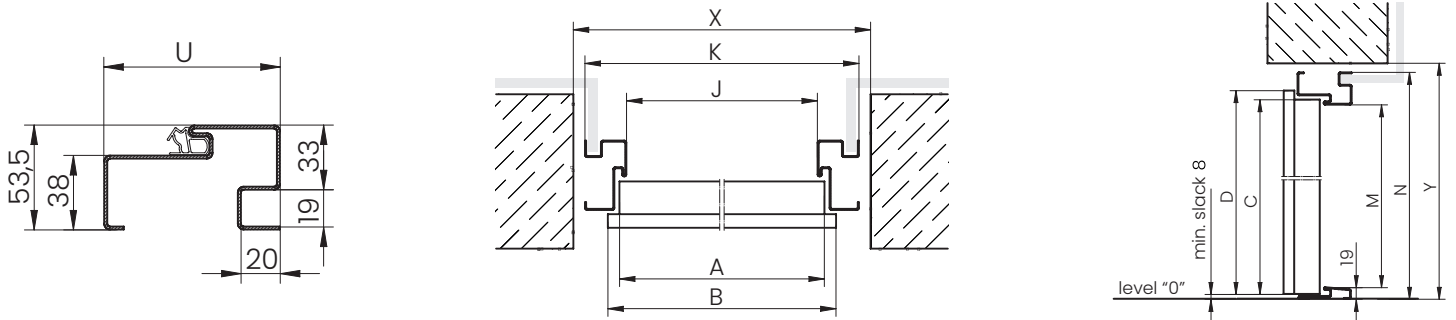

FT PORTAL

CORNER DOOR FRAME WITH GROOVE AND SEAL

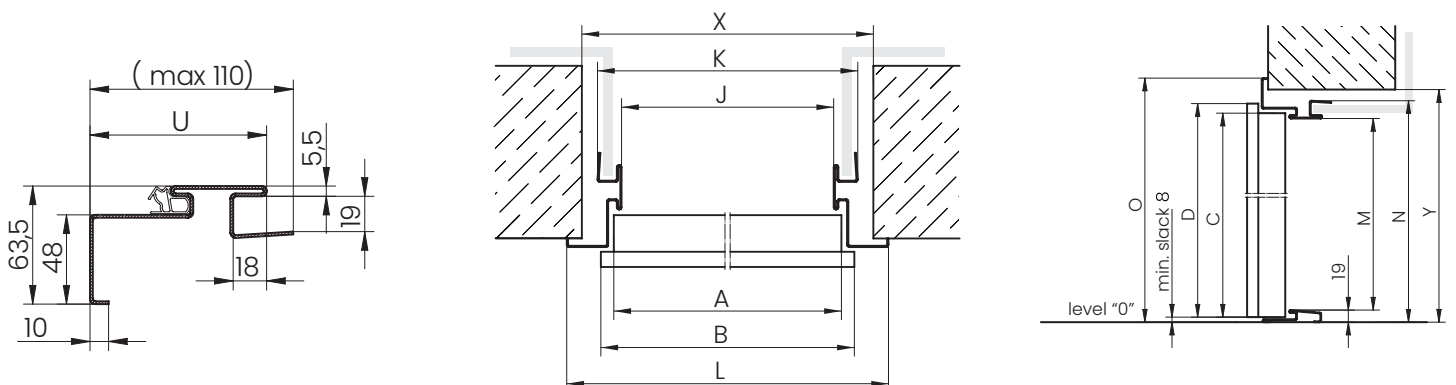

DOOR AND FRAME DIMENSIONS



ADDITIONAL INFORMATION FOR ASSEMBLY

STAR 60, PREMIUM 60, COMFORT 60 DOOR FRAME DIMENSIONS MOUNTING SYSTEM DPO (FRAME DOWEL JOINT)

	FDH3 FDH4 SYMMETRICAL DOOR FRAME WITHOUT SEAL						ASSEMBLY HOLE	
SIZE	J	K	L	M	N	O	X	Y
80N	764	860	-	2005	2072* 2078**	-	890	2085* 2091**
80	794	890	-			-	920	
90N	864	960	-			-	990	
90Z	927	1023	-			-	1053	
100E	1007	1103	-			-	1133	

* **FDH3** DOOR FRAME for thresholds: norwegian wooden height 28 mm, 19 mm and metal height 19 mm

** **FDH4** DOOR FRAME for thresholds: norwegian wooden height 35 mm and metal height 32 mm

	FNK1 FNK2 CORNER DOOR FRAME WITHOUT SEAL						ASSEMBLY HOLE	
SIZE	J	K	L	M	N	O	X	Y
80N	764	798	872	2005	2041* 2047**	2078* 2084**	829	2056* 2061**
80	794	828	902				859	
90N	864	898	972				929	
90Z	927	961	1035				992	
100E	1007	1041	1115				1072	

* **FNK1** DOOR FRAME for thresholds: norwegian wooden height 28 mm, 19 mm and metal height 19 mm

** **FNK2** DOOR FRAME for thresholds: norwegian wooden height 35 mm and metal height 32 mm

	FAP5 FAP6 FAP7 FAP FAP9 FAQ1 FAQ2 FAQ3 ASYMMETRICAL DOOR FRAME WITH SEAL						ASSEMBLY HOLE	
SIZE	J	K	L	M	N	O	X	Y
80N	765	861	-	2005	2072* 2078**	-	890	2085* 2091**
80	795	891	-				920	
90N	865	961	-				990	
90E***	908	1004	-				1033	
90Z	928	1024	-				1053	
100E	1008	1104	-				1133	

* **FAP5, FAP6, FAP7, FAP8** DOOR FRAME for thresholds: norwegian wooden height 28 mm, 19 mm and metal height 19 mm

** **FAP9, FAQ1, FAQ2, FAQ3** DOOR FRAME for thresholds: norwegian wooden height 35 mm and metal height 32 mm

*** size available for STAR 60 doors

STAR 60, PREMIUM 60, COMFORT 60 DOORS TECHNICAL DRAWINGS
MOUNTING SYSTEM DPO (FRAME DOWEL JOINT)

FDH3

FDH4

SYMMETRICAL DOOR FRAME WITHOUT SEAL

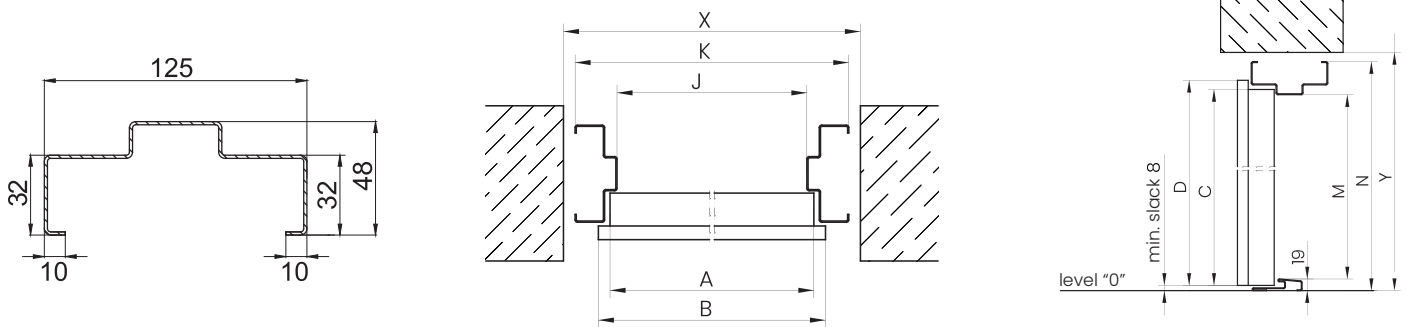

FNK1

FNK2

CORNER DOOR FRAME WITHOUT SEAL

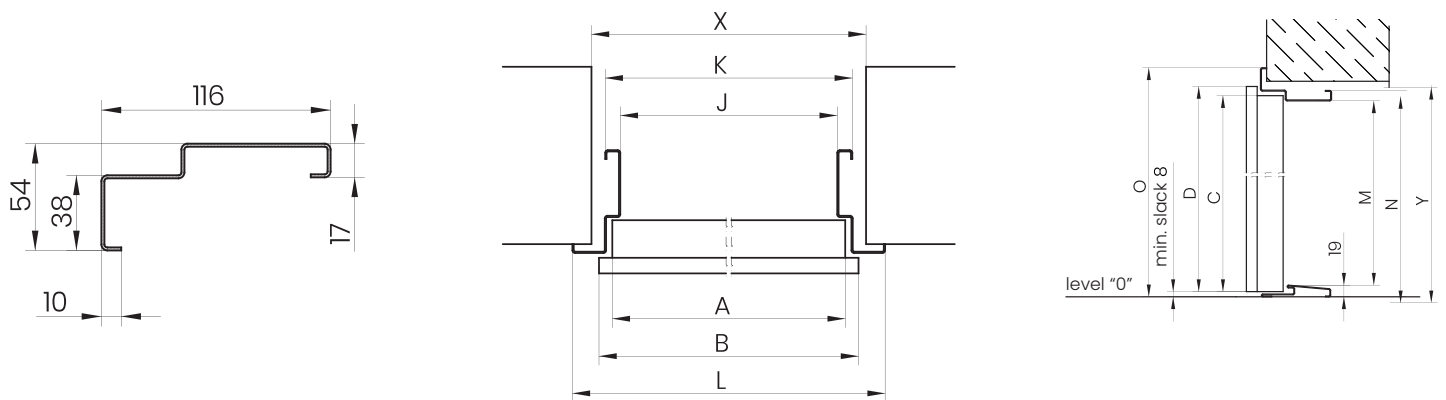

FAP5 FAP6 FAP7 FAP8 FAP9

FAQ1 FAQ2 FAQ3

ASYMMETRICAL DOOR FRAME WITH SEAL

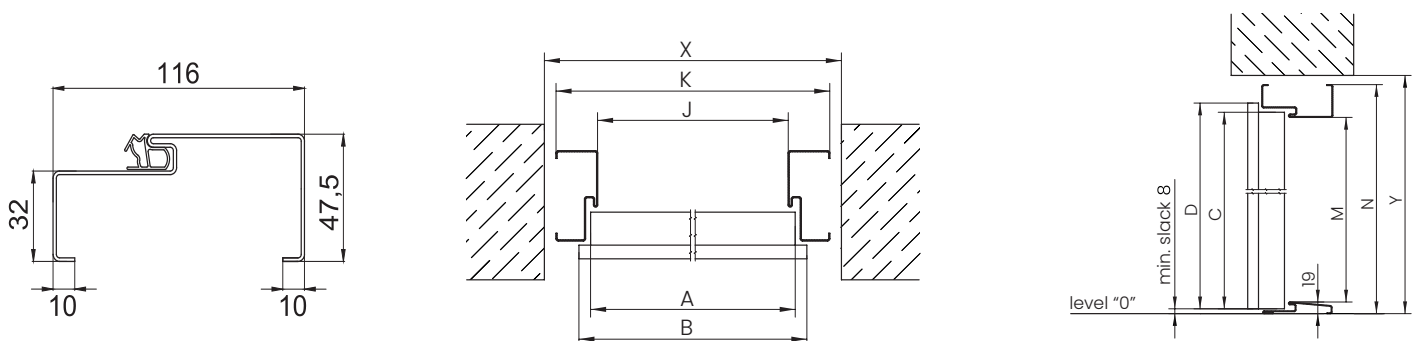

DOOR AND FRAME DIMENSIONS



ADDITIONAL INFORMATION FOR ASSEMBLY

STAR 60, PREMIUM 60, COMFORT 60 DOOR FRAME DIMENSIONS MOUNTING SYSTEM DPO (FRAME DOWEL JOINT)

SIZE	FTO5 FTO6 FTO7 FTO8 FTO9 FTP1 FTP2 FTP3 CORNER DOOR FRAME WITH SEAL						ASSEMBLY HOLE	
	J	K	L	M	N	O	X	Y
80N	765	799	872	2005	2041* 2047**	2078	829	2056* 2061**
80	795	829	902				859	
90N	865	899	972				929	
90E***	908	942	1015				972	
90Z	928	962	1035				992	
100E	1008	1042	1115				1072	

* **FTO5, FTO6, FTO7, FTO8** DOOR FRAME for thresholds: norwegian wooden height 28 mm, 19 mm and metal height 19 mm

** **FTO9, FTP1, FTP2, FTP3** DOOR FRAME for thresholds: norwegian wooden height 35 mm and metal height 32 mm

*** size available for STAR 60 doors

STAR 60, PREMIUM 60, COMFORT 60 DOORS TECHNICAL DRAWINGS MOUNTING SYSTEM DPO (FRAME DOWEL JOINT)

FTO5 FTO6 FTO7 FTO8 FTO9 FTP1 FTP2 FTP3 CORNER DOOR FRAME WITH SEAL

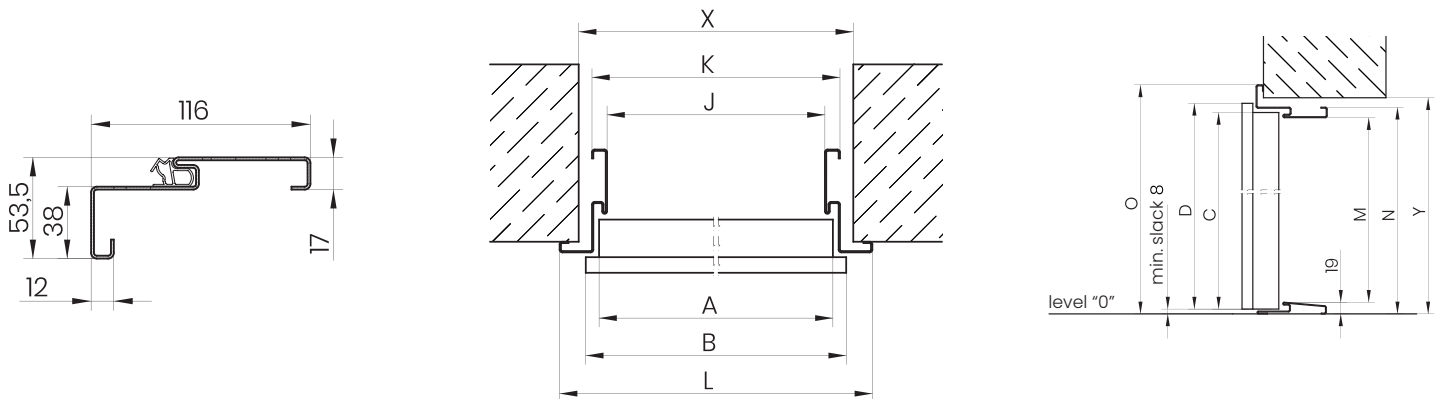

ENJOY DOOR LEAF DIMENSIONS

SIZE	DOOR LEAF DIMENSIONS			
	A	B	C	D
80	816	844	2025	2040
90	916	944		

ENJOY DOOR FRAME DIMENSIONS

SIZE	FA WOODEN ASYMMETRICAL DOOR FRAME WITH SEAL				ASSEMBLY HOLE	
	J	K	M	N	X	Y
80	800	887	2005	2070	907	2085
90	900	987			1007	

ENJOY DOOR TECHNICAL DRAWINGS

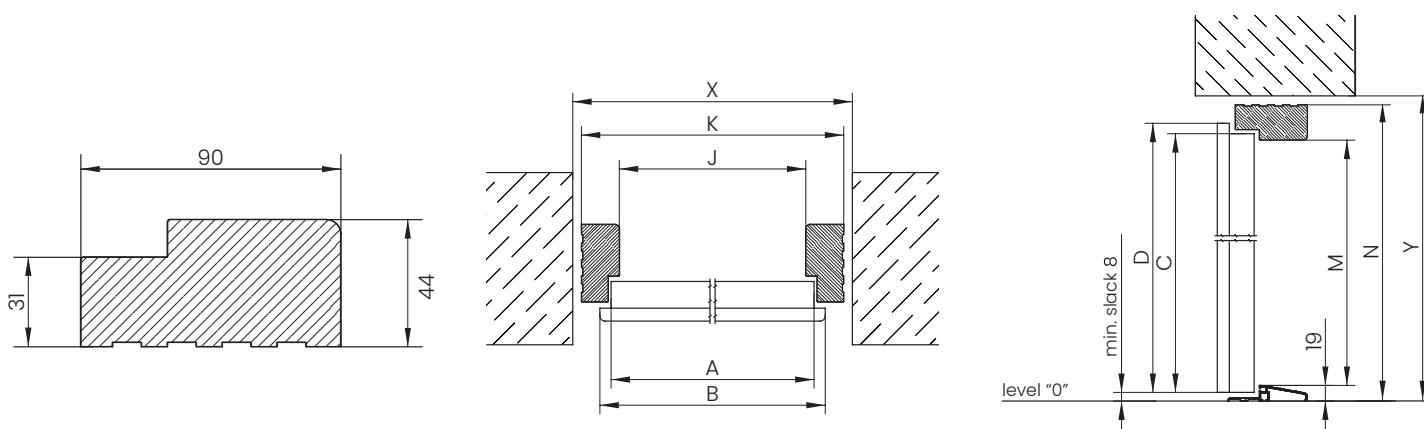

ALL AVAILABLE DOOR FRAMES FOR APARTMENTS ARE INCLUDED IN THE CATALOGUE OF DOOR FRAMES IN THE GEOS SYSTEM

INSPIRATIONS HIDDEN IN THE CREATIONS

GERDA®

OUR DOORS MOUNTED IN POLISH APARTMENTS



GERDA®

INSPIRATIONS HIDDEN IN THE CREATIONS

OUR DOORS MOUNTED IN POLISH APARTMENTS



INSPIRATIONS HIDDEN IN THE CREATIONS

GERDA®





Gerda Sp. z o.o.

Sokołów, ul. Sokołowska 49

05-806 Komorów

Poland

Phone: (+48) 22 329 10 30

e-mail: export@gerda.pl

www.gerda.pl

This product catalogue does not constitute an offer within the meaning of law and is for information purposes only.

Gerda, aiming to improve the quality of its products and services, reserves (without prior notice) the right to make changes to products which, due to the process of preparing printed materials, may not be included in this material.

Despite efforts to carefully control the information presented, factual or printing errors may occur.

The colours presented in the catalogue may differ from the original due to a different colour reproduction technique in the printing process.

The owner of copyrights of this catalogue and Gerda logos and graphic elements is Gerda Sp. z o.o.

It is forbidden to copy and distribute any content and materials without the prior consent of Gerda Sp. z o.o.