

# GERDA<sup>®</sup>

PREMIUM DOOR MANUFACTURER



## HOUSE DOORS

THERMO PRIME | THERMO PREMIUM | OPTIMA

# TABLE OF CONTENTS



STEP BY STEP TO YOUR NEW EXTERIOR DOOR

<b>TEDEE POWERED BY GERDA</b>	<b>3</b>
<b>READILY AVAILABLE DOORS</b>	<b>4</b>
<b>WHAT SHOULD YOU KNOW ABOUT GERDA DOORS</b>	<b>8</b>
<b>WHAT SHOULD YOU REMEMBER WHEN SELECTING GERDA DOORS</b>	<b>9</b>
<b>GERDA THERMO PRIME 75</b>	<b>12-13</b>
<b>GERDA THERMO PREMIUM 75</b>	<b>14-15</b>
<b>GERDA THERMO PREMIUM 60</b>	<b>16-17</b>
<b>GERDA OPTIMA 60</b>	<b>20-21</b>
<b>GERDA OPTIMA 50</b>	<b>22-23</b>
<b>AIR GLASS DOORS</b>	<b>26-31</b>
<b>QUADRO DOORS</b>	<b>32-53</b>
<b>ELITE 3D DOORS</b>	<b>54-55</b>
<b>TEMPO DOORS</b>	<b>56-75</b>
<b>CLASSIC DOORS</b>	<b>76-85</b>
<b>OPTIMA 60 DUO DOOR</b>	<b>86-87</b>
<b>ALUMINUM ILLUMINATORS</b>	<b>88-89</b>
<b>COLOURS</b>	<b>90-91</b>
<b>ACCESSORIES SET</b>	<b>92-93</b>
<b>OPTIONAL EQUIPMENT</b>	<b>94-99</b>
<b>DOOR AND DOOR FRAME SIZES</b>	<b>100-105</b>

TURN YOUR SMARTPHONE INTO A SMART DOOR LOCK



## OPEN DOORS WITH YOUR SMARTPHONE

Open and close doors and monitor door lock status from any place around the world. With the automatic opening feature, you don't need to take your phone out from your purse or pocket. The lock will detect your presence and let you in. The self-locking feature works based on the same principle.

## HIGH-PERFORMANCE BATTERY

Gerda engineers, in collaboration with the South Korean Research Institute, have developed a small dedicated high-performance battery. It powers the mechanism for six months of operation. And when in need of recharging, the lock will let you know as you can charge the battery overnight.

## SAFETY WARRANTY

The lock actuating mechanism is an innovative, patented design developed by Gerda engineers. The software was created by Tedee IoT experts. An intuitive app lets you keep track of who and when has locked or unlocked the door. It also offers a virtual key allocation feature.

## SET

TEDEE LOCK + TEDEE BRIDGE + CLASS 6 INSERTS



## CLASS 6 LOCK INSERT INCLUDED

- ✓ ANTI-BURGLARY TUMBLER LOCK INSERT. NEW LOCK INSERT DESIGN SECURED AGAINST 'LOCK BUMPING', WITH EFFECTIVE DRILL OPENING PROTECTION.



## INSTALL A TEDEE LOCK

- ✓ SLIDE THE LOCK ONTO A GERDA INSERT, ADJUST THE LOCK POSITION AND SECURE IT WITH ONE BOLT. INSTALLATION TAKES NO MORE THAN TWO MINUTES. INSPECT TO SEE WHETHER THE BOLTS SLIDE UPON TURNING THE KNOB.



## INSTALL THE SMARTPHONE APP

- ✓ DOWNLOAD THE TEDEE APP FROM APPLE STORE OR GOOGLE PLAY. SIGN UP AND ACTIVATE YOUR BLUE-TOOTH, LOCATION SERVICE AND INTERNET ACCESS. ADD YOUR LOCK AND ENTER THE ACTIVATION CODE.



## CONNECT THE BRIDGE

- ✓ FIND A FREE POWER SOCKET NEXT TO THE TEDEE LOCK AND PLUG THE BRIDGE IN. THIS WILL ENABLE YOU TO CONTROL THE LOCK OVER THE INTERNET FROM WHEREVER YOU ARE.

# READILY AVAILABLE DOORS

# GERDA®

OPTIMA 60



MILANO 8 NS1

DOOR MODEL	OPTIMA 60
SIZE	<b>90E</b>
COLOUR	ANTHRACITE (FKG), GOLD OAK (FDE)
DOOR FRAME	PERFOTHERM
GLASS	MATTE
SILL	ALUMINUM
EQUIPMENT	ESCUTCHEONS, LOCK BODY – DOOR HANDLE WITH INSERTS



HANOVER NS6

DOOR MODEL	OPTIMA 60
SIZE	<b>90E</b>
COLOUR	ANTHRACITE (FKG), GOLD OAK (FDE)
DOOR FRAME	PERFOTHERM
GLASS	MATTE
SILL	ALUMINUM
EQUIPMENT	ESCUTCHEONS, LOCK BODY – DOOR HANDLE WITH INSERTS

## ASSEMBLED DOOR (DOOR LEAF + DOOR FRAME + SILL)



**TOKIO 2A TMMA**

DOOR MODEL	OPTIMA 60
SIZE	<b>80</b> <b>90E</b>
COLOUR	ANTHRACITE (FKG), GOLD OAK (FDE)
DOOR FRAME	PERFOTHERM
SILL	ALUMINUM
EQUIPMENT	ESCUTCHEONS, LOCK BODY – DOOR HANDLE WITH INSERTS



**WOO FLAT**

DOOR MODEL	OPTIMA 60
SIZE	<b>80</b> <b>90E</b>
COLOUR	ANTHRACITE (FKG), GOLD OAK (FDE)
DOOR FRAME	PERFOTHERM
SILL	ALUMINUM
EQUIPMENT	ESCUTCHEONS, LOCK BODY – DOOR HANDLE WITH INSERTS



## DOORS

Our door frame and leaf solutions are perfect even for the most demanding facilities. Panel and metal doors in our offer feature superior durability, functionality (e.g. easy removal and replacement of a door panel) and the freedom of arrangement.



## LOCKS AND FITTINGS

Security first. Heat-treated inner die casts or steel plates ensure high resistance to burglary. Hardened tumbler insert cover protects against wrenching off and prevents drilling.

The MASTER KEY system is a solution dedicated for commercial facilities. A single key may be used to open a pre-determined number of locks. This way, moving around the facility is quick and easy, while zone and room access management is very comfortable.



## GATES

All garage gates in our offer comply with European standards. GERDA gates are fitted with comprehensive protection systems with no EXTRA CHARGE.

The "Trend" gate range is an economic but durable and functional solution, perfect for developer facilities.

The "Classic" gate range ensure very good thermal insulation, among others by means of 45-mm thick warm panels. Perfect for buildings with high energy efficiency requirements.



## ALUMINUM JOINERY

GERDA also offers aluminum joinery. We build partition walls, doors, windows, shop windows and both indoor and outdoor spatial installations, also in fire-resistant and smoke-tight or high burglary-resistant versions.

# WHAT SHOULD YOU KNOW ABOUT GERDA DOORS

## THERMAL INSULATION

Heat transfer coefficient ( $U_d$ ) indicates the amount of thermal energy passing through the door (including the door frame). Based on this coefficient, we are able to determine the heat loss for a given division. Even a slight loss translates to higher heating costs. The coefficient value depends on the type and thickness of the door's material. Gerda HOUSE DOORS comply with the current standards by using modern technologies and steel-wooden or aluminum door frames.

Gerda doors, depending on the components used, may have different insulation coefficient levels:

- insulation doors
- energy-saving doors
- passive doors

The basic doors in our offer, so-called insulation doors, have a coefficient below  $1.3 \text{ W/m}^2\text{K}$ . The door frame used is a steel PERFOTHERM® frame with thermal perforation, a seal and sill.

Energy-saving Optima 60 and Thermo Premium 60 doors have a coefficient starting from  $0.9 \text{ W/m}^2\text{K}$  with a warm aluminum ALUTHERM door frame (with thermal chamber filling and a seal) and  $1.0 \text{ W/m}^2\text{K}$  with DUOTHERM (warm steel-wooden door frame with thermal perforation and seal).

Passive doors are primarily meant to ensure maximum conservation of energy, while increasing the comfort of living. They allow for energy accumulation in the room, which leads to direct savings. Thermo Premium 75 doors feature a heat transfer coefficient from  $0.79 \text{ W/m}^2\text{K}$ . The heat transfer coefficient applies to solid doors with a warm aluminum ALUTHERM door frame.



## RESISTANCE TO BURGLARY

This parameter is decisive for the so-called anti-burglary doors. Such doors have a solid structure that significantly impedes the possibility to cut out an opening through the door, preventing unauthorized entrance. As a standard, GERDA doors are fitted with two robust locks with a multi-point bolting system. Their key element are anti-prizing bolts that prevent forcing the door leaf or lifting it off the hinges. GERDA doors are tested for resistance to burglary and hold an anti-burglary protection class from RC2/RC3 to RC3. The higher the class of doors installed, the greater the safety of people and property in the house.



## ANTI-BURGLARY PROTECTION CLASSES

### RC2 CLASS

- PLIERS
- WEDGE
- HAMMER

### RC3 CLASS

- STEEL PRY BAR
- WEDGE
- HAMMER
- MECHANICAL DRILL

### RC4 CLASS

- HEAVY HAMMER
- AXE
- CHISEL
- BIT
- HAMMER DRILL



# WHAT SHOULD YOU REMEMBER WHEN SELECTING GERDA DOORS

1

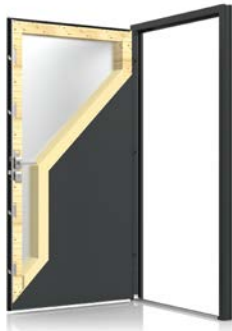

**WHAT SHOULD YOU REMEMBER WHEN SELECTING GERDA DOORS**

2



**CHOOSE THE STRUCTURE THAT BEST FITS YOUR NEEDS**

3

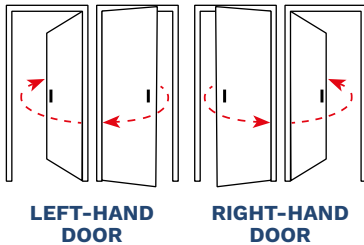

**CHECK THE AVAILABLE WIDTHS AND DECIDE**

4



**CREATE YOUR OWN INDIVIDUAL DESIGN BY CHOOSING THE PATTERNS OF VENEER AND APPLICATIONS**

5



**SELECT OPTIONAL ACCESSORIES: ILLUMINATORS, HANDLES, HANDLE PULLS, DOOR FRAMES**

# GERDA DOORS RANGE

# GERDA®

PREMIUM PRODUCT



**MILANO 8  
WINCHESTER**

**VILLACH  
STEEL GRAY**

**INNSBRUCK  
LIGHT WALNUT**



**REGEN 5**  
**DARK ANTHRACITE**







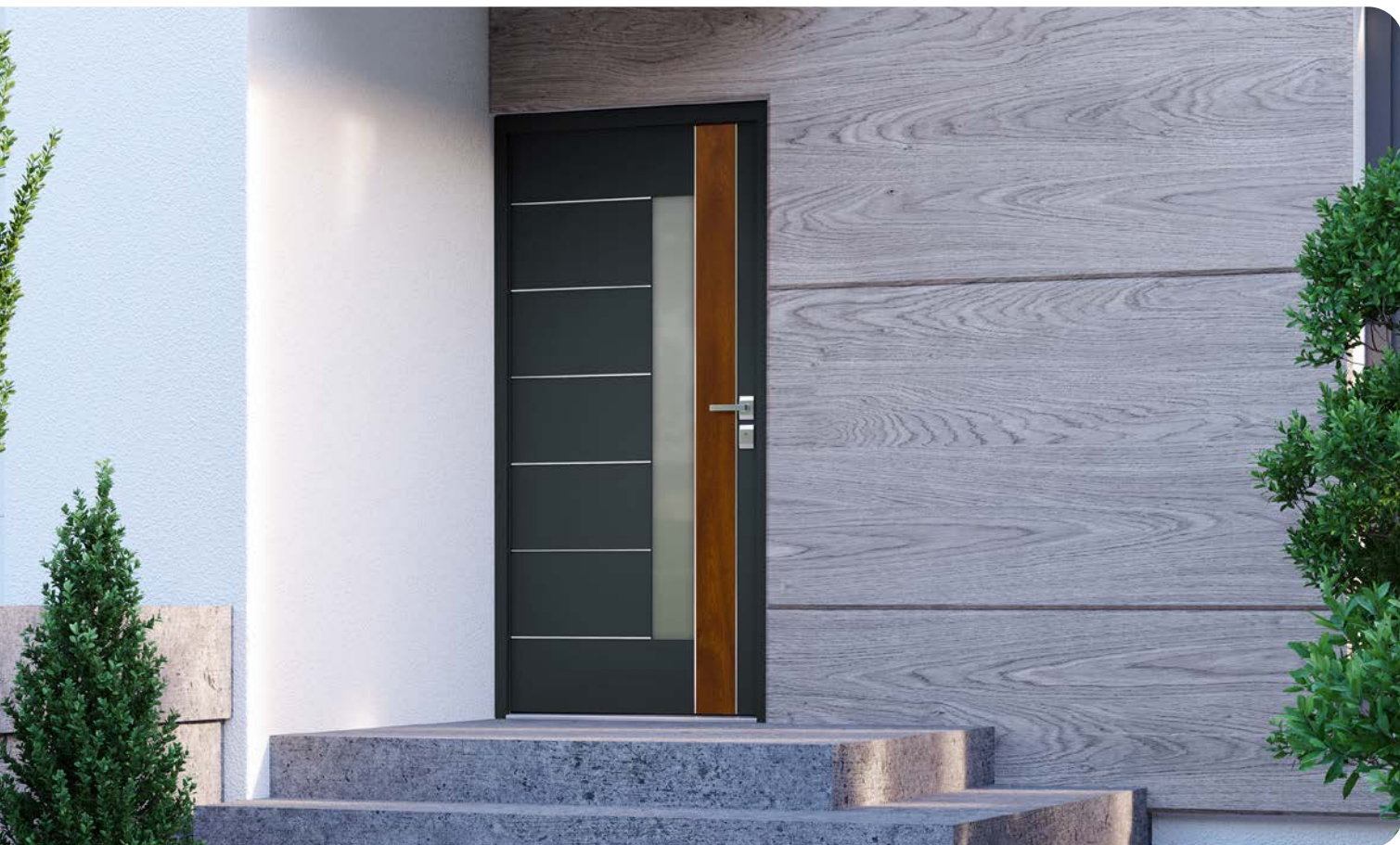

**BAMBERG 3**  
**TURNER OAK**

# GERDA THERMO PRIME 75



## PARAMETERS

	THERMAL INSULATION	<b>SOLID / GLAZED, ALUTHERM PRIME DOOR FRAME 0.79 W/m<sup>2</sup>K / 0.9 W/m<sup>2</sup>K</b>
	ANTI-BURGLARY PROTECTION CLASS	<b>RC2</b>
	LEAF THICKNESS	<b>75 mm</b>
	DOOR SIZES	<b>80, 90N, 90E, 100E*</b>
	DESIGN LINES	<b>4</b>
	LEAF STRUCTURE	<b>WOODEN FRAME + PUR FOAM</b>
	CUSTOM-SIZE DOOR	<b>DOOR HEIGHT UP TO 2400 mm</b>

\* EXTRA CHARGE

SOLID / GLAZED DOOR,  
ALUTHERM PRIME DOOR FRAME

UD = 0.79 W/m<sup>2</sup>K / 0.9 W/m<sup>2</sup>K

SOLID / GLAZED DOOR,  
STEEL DOOR FRAME

-

RC2

ALUTHERM PRIME DOOR FRAME



**ADJUSTABLE HOOK HITCHES**

Adjustable hook hitches with flexible teflon insert.



**THERMAL DIVISION**



**3D HINGE WITH CAPS**

Adjustable in three planes, caps in fitting colours



**DOOR THICKNESS**



**5-POINT MORTISE LOCK**

Lock installed along the entire height of the door leaf.

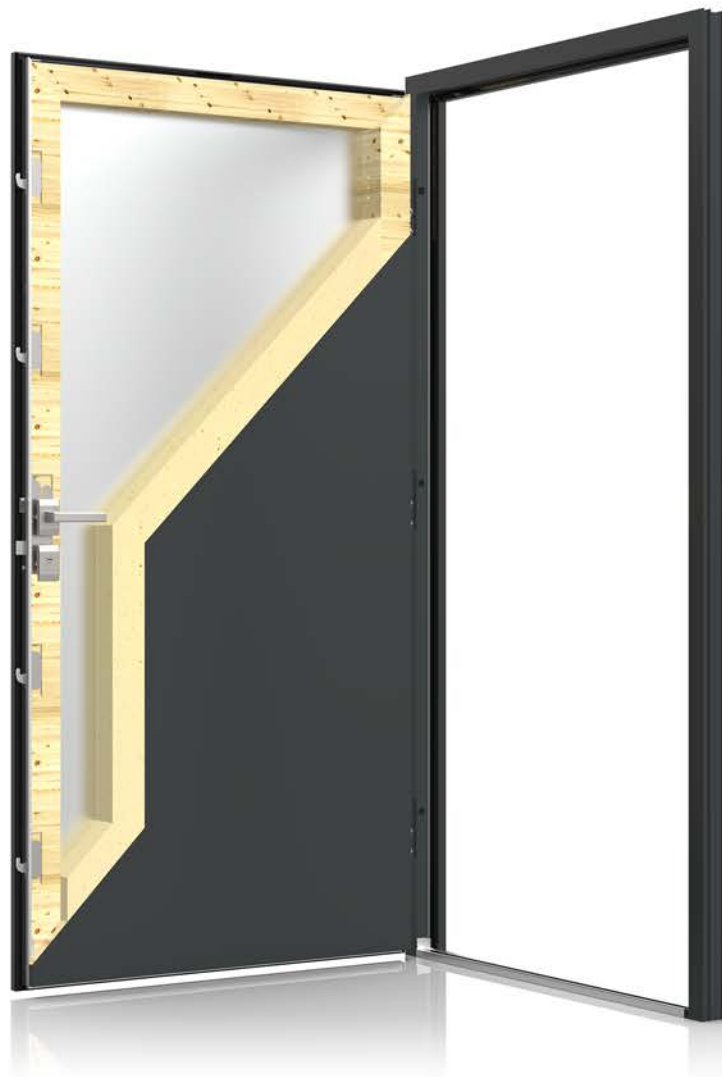

**ADJUSTABLE PAWL HITCH**

Enables smooth adjustment of the contact force of door and seals.



**RING ESCUTCHEON**

Available with a handhold



**ANTI-PRIZING BOLTS**

Fixed anti-prizing bolts in metal supports.



**WARM ALUMINUM SILL WITH CONNECTOR**



**LOWER UPSTAND, PRIME BRUSH SEAL**

ALUTHERM PRIME DOOR FRAME

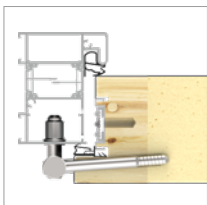

SILL

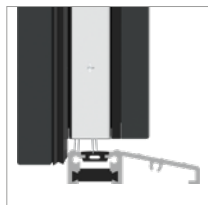

KEY

STANDARD EQUIPMENT

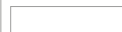

OPTIONAL EQUIPMENT (OPTIONAL FOR A FEE)



# GERDA THERMO PREMIUM 75

# GERDA®



## PARAMETERS

<b>UD</b>	THERMAL INSULATION	<b>SOLID / GLAZED, DUOTHERM DOOR FRAME 0.9 W/m<sup>2</sup>K / 1.3 W/m<sup>2</sup>K</b>	<b>SOLID / GLAZED, ALUTHERM PREMIUM DOOR FRAME 0.8 W/m<sup>2</sup>K / 1.1 W/m<sup>2</sup>K</b>
<b>RC</b>	ANTI-BURGLARY PROTECTION CLASS		<b>RC2 / RC3*</b>
	LEAF THICKNESS		<b>75 mm</b>
	DOOR SIZES		<b>80, 90N, 90E, 100E**</b>
	DESIGN LINES		<b>4</b>
	LEAF STRUCTURE	<b>WOODEN FRAME + EXPANDED GRAPHITE POLYSTYRENE</b>	

**\* ONLY FULL DOORS, EXTRA CHARGE**  
**\*\* EXTRA CHARGE**

**SOLID / GLAZED DOOR,  
ALUTHERM PREMIUM DOOR FRAME**

**UD = 0.8 W/m<sup>2</sup>K / 1.1 W/m<sup>2</sup>K**

**SOLID / GLAZED DOOR,  
DUOTHERM DOOR FRAME**

**UD = 0.9 W/m<sup>2</sup>K / 1.3 W/m<sup>2</sup>K**

**RC2/RC3**



**VERTICAL BOLT**

Anti-burglary vertical bolt controlled with the main lock for RC3



**THERMAL DIVISION**

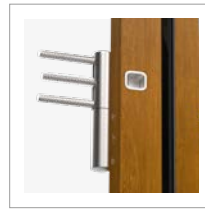

**3D HINGE WITH CAPS**

Adjustable in three planes, caps in fitting colours



**DOOR THICKNESS**



**ADDITIONAL LOCK**

3-bolt class 6  
GERDA ZW 500



**MAIN LOCK**

Central lock  
3-bolt class 7 GERDA ZW 2000



**AUXILIARY LOCK**

2-bolt



**ADJUSTABLE  
PAWL HITCH**

Enables smooth adjustment of the contact force of door and seals.

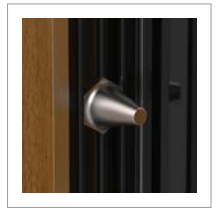

**ANTI-PRIZING BOLTS**

Fixed anti-prizing bolts in metal supports.



**LOWER UPSTAND,  
BRUSH SEAL**

**ALUTHERM PREMIUM  
DOOR FRAME**

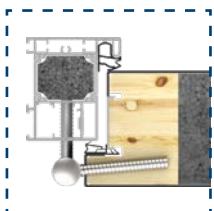

**DUOTHERM  
DOOR FRAME**



**SILL**

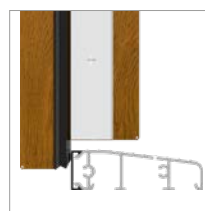

**KEY**

STANDARD EQUIPMENT



OPTIONAL EQUIPMENT  
(OPTIONAL FOR A FEE)



# GERDA THERMO PREMIUM 60



## PARAMETERS

<b>UD</b>	THERMAL INSULATION	<b>SOLID / GLAZED, DUOTHERM DOOR FRAME 1.0 W/m<sup>2</sup>K / 1.3 W/m<sup>2</sup>K</b>	<b>SOLID / GLAZED, ALUTHERM PREMIUM DOOR FRAME 0.9 W/m<sup>2</sup>K / 1.2 W/m<sup>2</sup>K</b>
<b>RC</b>	ANTI-BURGLARY PROTECTION CLASS		<b>RC2 / RC3*</b>
<b>K</b> mm	LEAF THICKNESS		<b>60 mm</b>
<b>D</b>	DOOR SIZES		<b>80, 90N, 90E, 100E**</b>
<b>G</b>	DESIGN LINES		<b>4</b>
<b>W</b>	LEAF STRUCTURE	<b>WOODEN FRAME + EXPANDED GRAPHITE POLYSTYRENE</b>	

**\* ONLY FULL DOORS, EXTRA CHARGE**  
**\*\* EXTRA CHARGE**



SOLID / GLAZED DOOR,  
ALUTHERM PREMIUM DOOR FRAME

SOLID / GLAZED DOOR,  
DUOTHERM DOOR FRAME

UD = 0.9 W/m<sup>2</sup>K / 1.2 W/m<sup>2</sup>K

UD = 1.0 W/m<sup>2</sup>K / 1.3 W/m<sup>2</sup>K

RC2/RC3



**VERTICAL BOLT**

Anti-burglary vertical bolt controlled with the main lock for RC3

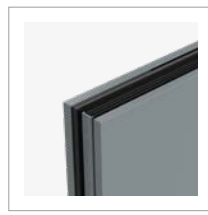

**THERMAL DIVISION**



**3D HINGE WITH CAPS**

Adjustable in three planes, caps in fitting colours



**DOOR THICKNESS**



**ADDITIONAL LOCK**

3-bolt class 6  
GERDA ZW 500

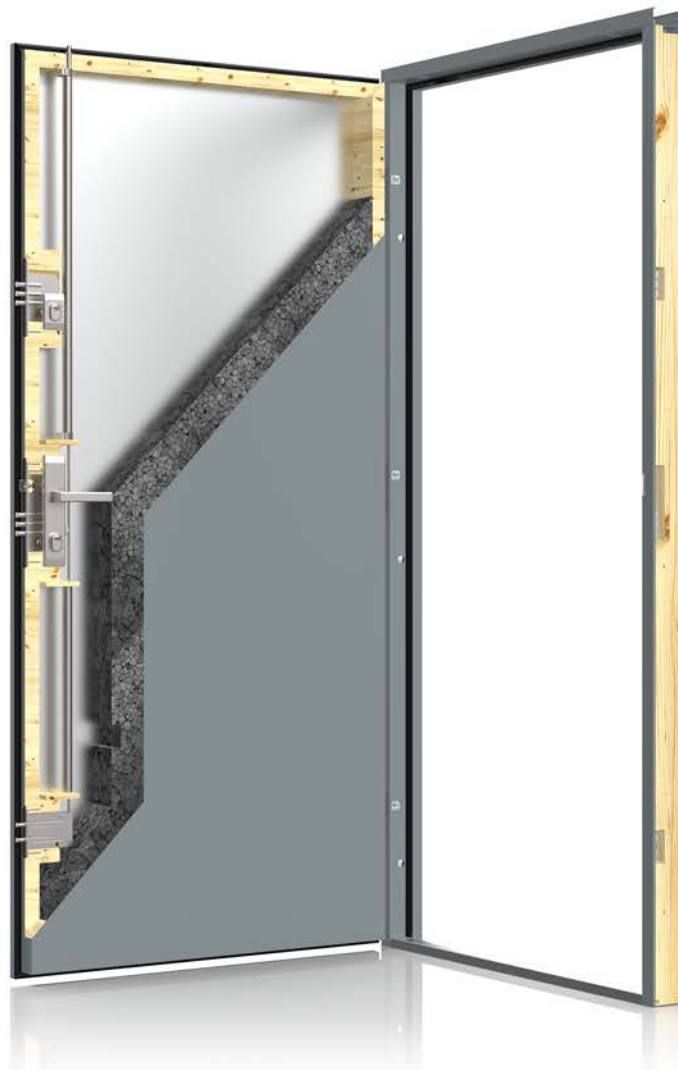

**ADJUSTABLE PAWL HITCH**

Enables smooth adjustment of the contact force of door and seals.



**MAIN LOCK**

3-ryglowy klasy 7 GERDA ZW1000,  
dla RC3 zamek centralny ZW2000



**ANTI-PRIZING BOLTS**

Fixed anti-prizing bolts in metal supports.



**AUXILIARY LOCK**

2-bolt for RC3



**LOWER UPSTAND, BRUSH SEAL**

ALUTHERM PREMIUM  
DOOR FRAME



DUOTHERM  
DOOR FRAME



SILL

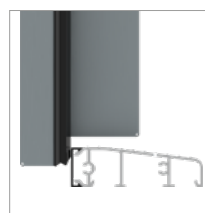

KEY

STANDARD EQUIPMENT



OPTIONAL EQUIPMENT  
(OPTIONAL FOR A FEE)



## AIR GLASS



AGB LINZ 1 p. 26



AGC LINZ 2 p. 26



AGD LINZ 3 p. 26



AGDB LINZ 3 B p. 26



AGE GRAZ 1 p. 28



AGF GRAZ 2 p. 28



AGG GRAZ 3 p. 29

## QUADRO



KWA PASAWA 1 p. 32



KWB PASAWA 2 p. 32



KWC PASAWA 3 p. 33



KWD PASAWA 4 p. 33



KWE JENA 3 p. 34



KW4 JENA 4 p. 34



KWF BAMBERG 1 p. 36



KWN TREWIR 3 p. 41



KWP TREWIR 4 p. 41



KW7 TREWIR 7 p. 41



KWS DORFEN p. 42



KWT KASSEL 1 p. 44



KWX KASSEL 2 p. 44



KPN KRONACH 1 p. 46



KPM REGEN 5 p. 49



KPR REGEN 6 p. 49



KPRB REGEN 6 B p. 49



KPE DREZNO 1 p. 50



KPF DREZNO 2 p. 50



KPH DREZNO 4 p. 51



KPA ERFURT 1 p. 52

## ELITE 3D



ELA BRIG p. 54



ELB OLTEN p. 54



ELC VISP p. 55



ELD TRIN p. 55



ELE BERNO p. 55

## TEMPO



NS1 MILANO 8 p. 56



NS2 MILANO 9 p. 56



AGGB GRAZ 3 B p. 29



AGA SALZBURG p. 30



AGH VILLACH p. 30



AGHB VILLACH B p. 30



KWG BAMBERG 2 p. 36



KWH BAMBERG 3 p. 37



KWI BAMBERG 4 p. 37



KWJ ULM 1 p. 38

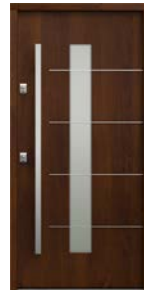

KWK ULM 2 p. 38



KWL TREWIR 1 p. 40



KWM TREWIR 2 p. 40



KPP KRONACH 2 p. 46



KPT KRONACH 3 p. 47



KPZ KRONACH 4 p. 47



KPJ REGEN 1 p. 48



KPK REGEN 2 p. 48



KPL REGEN 3 p. 49



KPS REGEN 4 p. 49



KPB ERFURT 2 p. 52



KPC ERFURT 3 p. 53



NS3 MILANO 10 p. 57



NS4 MILANO 11 p. 57



NS9B MILANO 12 B p. 57



NSSB HANOVER 5 B p. 58



NS6 HANOVER 6 p. 58



NS7 INNSBRUCK p. 59



W00 FLAT p. 60

# GERDA OPTIMA 60



## PARAMETERS

<b>UD</b>	THERMAL INSULATION	<b>SOLID / GLAZED, PERFOTHERM DOOR FRAME 1.1 W/m<sup>2</sup>K / 1.3 W/m<sup>2</sup>K</b>	<b>SOLID / GLAZED, ALUTHERM PREMIUM DOOR FRAME 1.0 W/m<sup>2</sup>K / 1.3 W/m<sup>2</sup>K</b>
<b>RC</b>	ANTI-BURGLARY PROTECTION CLASS		<b>RC2 / RC3*</b>
<b>K</b> mm	LEAF THICKNESS		<b>60 mm</b>
<b>D</b>	DOOR SIZES		<b>80N, 80, 90N, 90E, 100E**</b>
<b>G</b>	DESIGN LINES		<b>2</b>
<b>W</b>	LEAF STRUCTURE	<b>WOODEN BLOCKS + WOODEN FRAME + EXPANDED GRAPHITE POLYSTYRENE</b>	

**\* ONLY FULL DOORS, EXTRA CHARGE**  
**\*\* EXTRA CHARGE**

**SOLID / GLAZED DOOR,  
ALUTHERM PREMIUM DOOR FRAME**

**UD = 1.0 W/m<sup>2</sup>K / 1.3 W/m<sup>2</sup>K**

**SOLID / GLAZED DOOR,  
DUOTHERM DOOR FRAME**

**UD = 1.1 W/m<sup>2</sup>K / 1.3 W/m<sup>2</sup>K**

**RC2/RC3**



**VERTICAL BOLT**

Anti-burglary vertical bolt controlled with the main lock for RC3

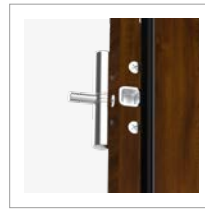

**2D HINGE WITH CAPS**

Caps in fitting colours



**DOOR THICKNESS**



**ADDITIONAL LOCK**

3-bolt class 6  
GERDA ZW 500



**MAIN LOCK**

3-bolt class 7 GERDA ZW 1000,  
ZW 2000 central lock for RC3



**AUXILIARY LOCK**

2-bolt for RC3



**ADJUSTABLE  
PAWL HITCH**

Enables smooth adjustment of the  
contact force of door and seals.



**ANTI-PRIZING BOLTS**

Fixed anti-prizing bolts  
in metal supports.

**ALUTHERM OPTIMA  
DOOR FRAME**

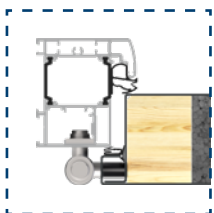

**PERFOTHERM  
DOOR FRAME**

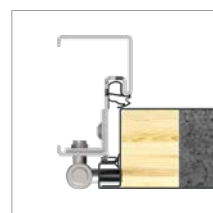

**SILL**



**KEY**

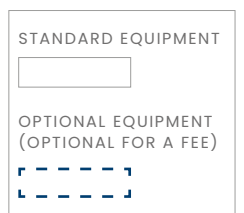

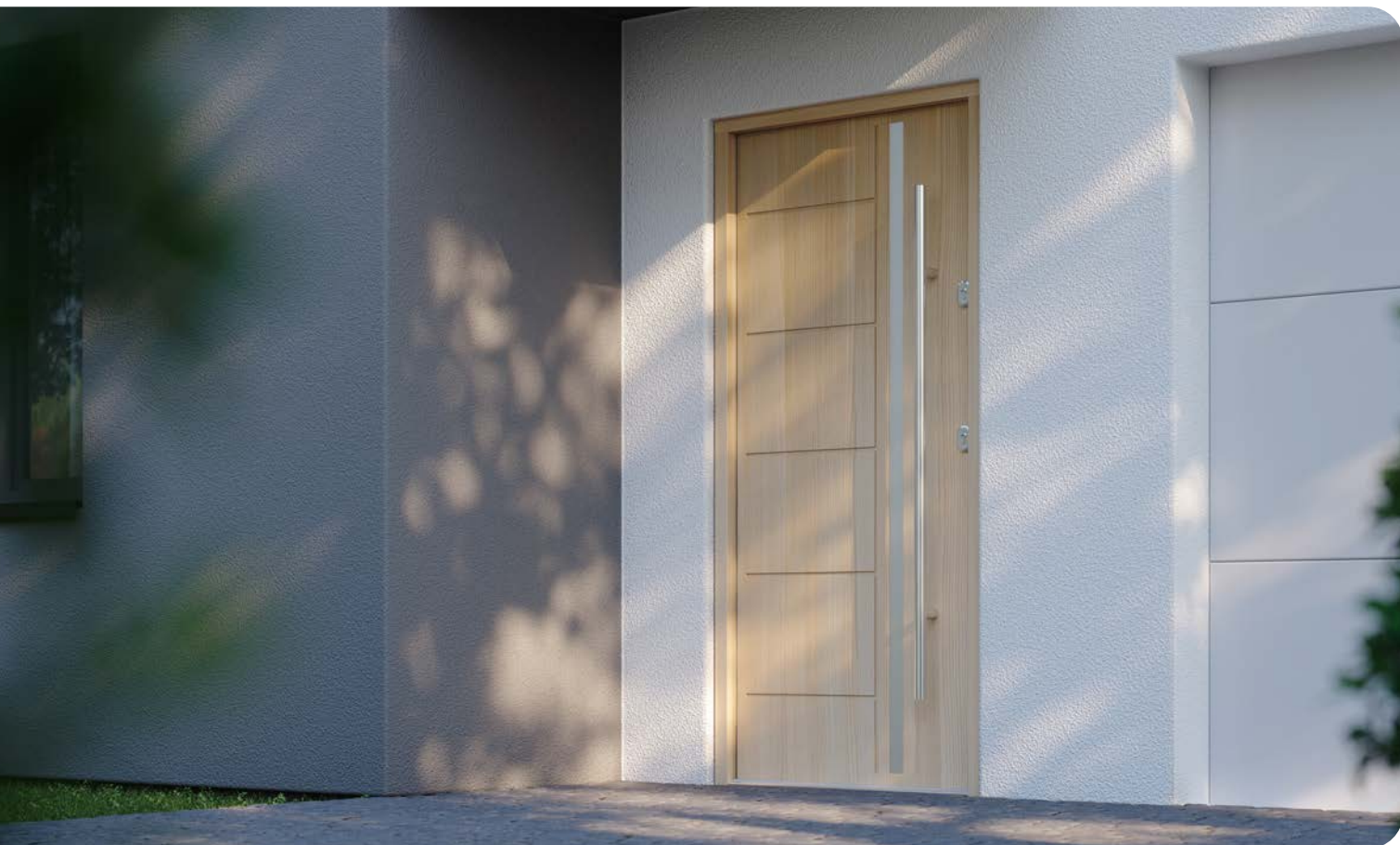

## PARAMETERS

<b>UD</b>	THERMAL INSULATION	<b>SOLID PERFOTHERM DOOR FRAME 1.2 W/m<sup>2</sup>K</b>
<b>RC</b>	ANTI-BURGLARY PROTECTION CLASS	<b>RC2</b>
	LEAF THICKNESS	<b>50 mm</b>
	DOOR SIZES	<b>80N, 80, 90N, 90E, 100E*</b>
	DESIGN LINES	<b>2</b>
	LEAF STRUCTURE	<b>WOODEN BLOCKS + WOODEN FRAME + EXPANDED GRAPHITE POLYSTYRENE</b>

\* EXTRA CHARGE

SOLID / GLAZED DOOR,  
ALUMINUM DOOR FRAME

-

SOLID / GLAZED DOOR,  
PERFOTHERM DOOR FRAME

UD = 1.2 W/m<sup>2</sup>K

RC2



**2D HINGE WITH CAPS**  
Caps in fitting colours



**DOOR THICKNESS**

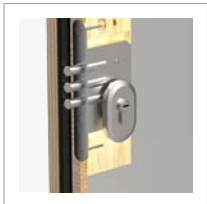

**ADDITIONAL LOCK**  
3-bolt class 6  
GERDA ZW 500

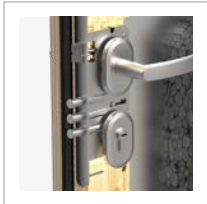

**MAIN LOCK**  
3-bolt class 7  
GERDA ZW 1000



**ADJUSTABLE PAWL HITCH**  
Enables smooth adjustment of the contact force of door and seals.



**ANTI-PRIZING BOLTS**  
Fixed anti-prizing bolts in metal supports.

PERFOTHERM  
DOOR FRAME

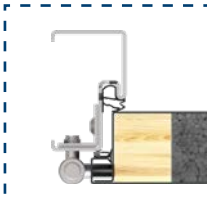

\* COMPATIBLE WITH WOODEN SILLS

FB  
DOOR FRAME

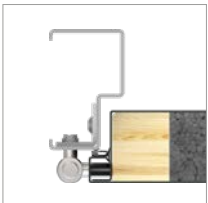

FN  
DOOR FRAME

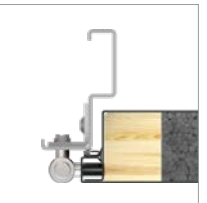

SILL



KEY

STANDARD EQUIPMENT



OPTIONAL EQUIPMENT  
(OPTIONAL FOR A FEE)



## TEMPO



NS1 MILANO 8 p. 56



NS2 MILANO 9 p. 56



NS3 MILANO 10 p. 57



NS4 MILANO 11 p. 57



NS9 MILANO 12 p. 57



NS9B MILANO 12 B p. 57



NS5 HANOVER 5 p. 58



NT1 TURYN 1 p. 64



NT2 TURYN 2 p. 65



SOJ BERGAMO 2 p. 66



SJ9 NICEA 9 p. 66



SBE BERLIN 4 p. 67



ST4 UPPSALA 1 p. 68



ST4A UPPSALA 1A p. 68



ST9 LUND 1 p. 72



WBA ASPEN 1 p. 73



TN7 ASPEN 2 p. 73



TN7B ASPEN 2B p. 73



SR3 TROMSO 1 p. 74

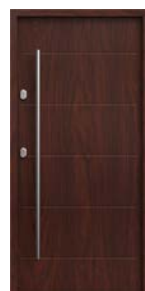

SR4 TROMSO 1 p. 74



SR5 TROMSO 2 p. 75

## CLASSIC



W76 MODENA p. 76



W77 MODENA 2 p. 76



W78 MODENA 3 p. 77



WDR RAVENA p. 77



WJ1 NICEA 5 p. 78



W23 OLYMPIA p. 79



W91 WERONA p. 80



W24 LIZBONA p. 82



W9N WENECJA p. 82



W13 LONDYN p. 83



W5L LONDYN 1 p. 83



W54 BARCELONA p. 84



W53 BARCELONA 1 p. 84



G76 GENEWA 1 p. 85





NS5B HANOVER 5 B p. 58



NS6 HANOVER 6 p. 58



NS7 INNSBRUCK p. 59



W00 FLAT p. 60



W00 FLAT p. 60



SNU MILANO 4 p. 62



SNUA MILANO 4A p. 62



ST5 UPPSALA 2 p. 69



ST5A UPPSALA 2A p. 69



TML TOKIO 1 p. 70



TMLA TOKIO 1A p. 70



TMM TOKIO 2 p. 71



TMMa TOKIO 2A p. 71



ST8 RYGA p. 72



SR5 TROMSO 2 p. 75



W94 WERONA 1 p. 80



W93 WERONA 3 p. 81



W6A WERONA 4 p. 81



WQA WERONA 5 p. 81



G75 GENEWA 2 p. 85



D75 GENEWA 3 p. 85

# AIR GLASS LINZ

# GERDA®



AGB LINZ 1



AGC LINZ 2

SIZE	80	90N	90E	100E
------	----	-----	-----	------

MODEL	THERMO PREMIUM 60	THERMO PREMIUM 75	THERMO PRIME 75
AGB / AGBB LINZ 1	✓	✓	✓
AGC / AGCB LINZ 2	✓	✓	✓
AGD / AGDB LINZ 3	✓	✓	✓

## RC2 STANDARD EQUIPMENT

- GLAZED DOOR LEAF, COMPLIANT WITH THE "CLEAN AIR" PROGRAM TERMS
- 4 DOOR LEAF UPSTANDS
- THERMO PREMIUM DUOTHERM / THERMO PRIME DOOR FRAME ALUTHERM PRIME DOOR FRAME
- 3D-ADJUSTABLE HINGES WITH CAPS IN FITTING COLOURS
- WARM SILL
- FITTINGS SET WITH INSERT PROTECTION
- BERGEN ESCUTCHEONS WITH ALEX HANDLES
- CLASS 5 LOCK INSERTS, ONE KEY SYSTEM FOR THERMO PREMIUM DOORS

• INSERTS **INOX** **BLACK**

## EXTRA CHARGES

ALUTHERM PREMIUM DOOR FRAME (THERMO PREMIUM DOOR)	✓	ELECTRIC STRIKE WITH DAY / NIGHT FEATURE	✓
TWO-COLOUR DOOR	✓	AMSTERDAM / MONTREAL HANDHOLD 1500 mm, RECOMMENDED ELECTRIC STRIKE	✓
CLASS 6 LOCK INSERTS, ONE KEY SYSTEM	✓	AMSTERDAM / MONTREAL HANDHOLD 1000 mm, RECOMMENDED ELECTRIC STRIKE	✓
UPPER ESCUTCHEON PROTECTION (THERMO PREMIUM)	✓	AMSTERDAM / MONTREAL HANDHOLD 1500 mm WITH PUSHBUTTON, WITH DOOR LEAF ADJUSTMENT, ELECTRIC STRIKE REQUIRED	✓
KNOB-HANDLE	✓	AMSTERDAM / MONTREAL HANDHOLD 1000 mm WITH PUSHBUTTON, WITH DOOR LEAF ADJUSTMENT, ELECTRIC STRIKE REQUIRED	✓
REED SWITCH	✓	TEDEE SET	✓
SIZE 100E	✓		

\* FIXED ALUMINUM ILLUMINATORS – PAGES 88–89, FULL EQUIPMENT LIST – PAGES 94–99

## GLASS



GRAPHITE

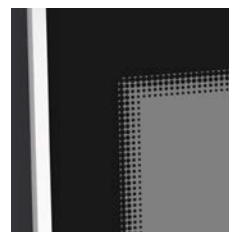

INOX

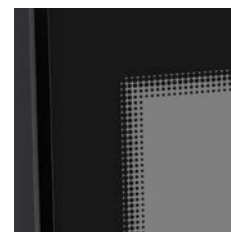

BLACK

## DOOR COLOURS

ALPINE WALNUT



FRR

MAHOGANY



FMA

BRAZILIAN WALNUT



FRB

LIGHT WALNUT



FRP

GOLD OAK



FDE

WINCHESTER



FDW

TURNER OAK



FDT

LIGHT WENGE



FEJ

WHITE



FSB

STEEL GRAY



FKZ

ANTHRACITE



FKG

DARK ANTHRACITE



FKF

BLACK



FKC



AGD LINZ 3



INTERNAL SIDE

### THERMO PRIME 75 DOOR CONFIGURATION



AGDB LINZ 3 B



INTERNAL SIDE

#### FITTINGS

HANDLE-HANDLE



**THERMO PRIME**

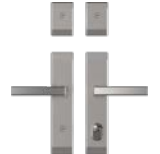

**THERMO PREMIUM**

HANDLE-KNOB



**THERMO PRIME**



**THERMO PREMIUM**

HANDHOLD



□ AMSTERDAM  
○ MONTREAL

#### FITTING COLOURS

**PLATINUM ANODE**



**SILVER ANODE**



**BLACK ANODE**



#### DOOR COLOURS

ALPINE WALNUT



FRR

MAHOGANY



FMA

BRAZILIAN WALNUT



FRB

LIGHT WALNUT



FRP

GOLD OAK



FDE

WINCHESTER



FDW

TURNER OAK



FDT

LIGHT WENGE



FEJ

WHITE



FSB

STEEL GRAY



FKZ

ANTHRACITE



FKG

DARK ANTHRACITE



FKF

BLACK



FKC

# AIR GLASS GRAZ

# GERDA®



AGE GRAZ 1



AGF GRAZ 2

SIZE	80	90N	90E	100E
------	----	-----	-----	------

MODEL	THERMO PREMIUM 60	THERMO PREMIUM 75	THERMO PRIME 75
AGE / AGEB GRAZ 1	✓	✓	✓
AGF / AGFB GRAZ 2	✓	✓	✓
AGG / AGGB GRAZ 3	✓	✓	✓

## RC2 STANDARD EQUIPMENT

- GLAZED DOOR LEAF, COMPLIANT WITH THE "CLEAN AIR" PROGRAM TERMS
- 4 DOOR LEAF UPSTANDS
- THERMO PREMIUM DUOTHERM / THERMO PRIME DOOR FRAME ALUTHERM PRIME DOOR FRAME
- 3D-ADJUSTABLE HINGES WITH CAPS IN FITTING COLOURS
- WARM SILL
- FITTINGS SET WITH INSERT PROTECTION
- BERGEN ESCUTCHEONS WITH ALEX HANDLES
- CLASS 5 LOCK INSERTS, ONE KEY SYSTEM FOR THERMO PREMIUM DOORS

- INSERTS **INOX** **BLACK**

## EXTRA CHARGES

ALUTHERM PREMIUM DOOR FRAME (THERMO PREMIUM DOOR)	✓	ELECTRIC STRIKE WITH DAY / NIGHT FEATURE	✓
TWO-COLOUR DOOR	✓	AMSTERDAM / MONTREAL HANDHOLD 1500 mm, RECOMMENDED ELECTRIC STRIKE	✓
CLASS 6 LOCK INSERTS, ONE KEY SYSTEM	✓	AMSTERDAM / MONTREAL HANDHOLD 1000 mm, RECOMMENDED ELECTRIC STRIKE	✓
UPPER ESCUTCHEON PROTECTION (THERMO PREMIUM)	✓	AMSTERDAM / MONTREAL HANDHOLD 1500 mm WITH PUSHBUTTON, WITH DOOR LEAF ADJUSTMENT, ELECTRIC STRIKE REQUIRED	✓
KNOB-HANDLE	✓	AMSTERDAM / MONTREAL HANDHOLD 1000 mm WITH PUSHBUTTON, WITH DOOR LEAF ADJUSTMENT, ELECTRIC STRIKE REQUIRED	✓
REED SWITCH	✓	TEDEE SET	✓
SIZE 100E	✓		

\* FIXED ALUMINUM ILLUMINATORS – PAGES 88–89, FULL EQUIPMENT LIST – PAGES 94–99

## GLASS



GRAPHITE

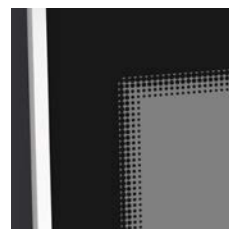

INOX



BLACK

## DOOR COLOURS

ALPINE WALNUT



FRR

MAHOGANY



FMA

BRAZILIAN WALNUT



FRB

LIGHT WALNUT



FRP

GOLD OAK



FDE

WINCHESTER



FDW

TURNER OAK



FDT

LIGHT WENGE



FEJ

WHITE

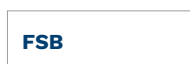

FSB

STEEL GRAY



FKZ

ANTHRACITE



FKG

DARK ANTHRACITE



FKF

BLACK



FKC



AGGB GRAZ 3 B



INTERNAL SIDE

## THERMO PRIME 75 DOOR CONFIGURATION



AGF GRAZ 2



INTERNAL SIDE

### FITTINGS

HANDLE-HANDLE



THERMO PRIME



THERMO PREMIUM

HANDLE-KNOB



THERMO PRIME



THERMO PREMIUM

HANDHOLD



□ AMSTERDAM  
○ MONTREAL

FITTING COLOURS

PLATINUM ANODE



SILVER ANODE



BLACK ANODE



## DOOR COLOURS

ALPINE WALNUT



FRR

MAHOGANY



FMA

BRAZILIAN WALNUT



FRB

LIGHT WALNUT



FRP

GOLD OAK



FDE

WINCHESTER



FDW

TURNER OAK



FDT

LIGHT WENGE



FEJ

WHITE



FSB

STEEL GRAY



FKZ

ANTHRACITE



FKG

DARK ANTHRACITE



FKF

BLACK



FKC

# AIR GLASS SALZBURG / VILLACH



AGA SALZBURG



AGHB VILLACH B

SIZE (AGA SALZBURG)	80	90N	90E	100E
SIZE (AGH VILLACH)	-	-	90E	100E

MODEL	THERMO PREMIUM 60	THERMO PREMIUM 75	THERMO PRIME 75
AGA / AGAB SALZBURG	✓	✓	✓
AGH / AGHB VILLACH	✓	✓	✓

## RC2 STANDARD EQUIPMENT

- GLAZED DOOR LEAF, COMPLIANT WITH THE "CLEAN AIR" PROGRAM TERMS
- 4 DOOR LEAF UPSTANDS
- THERMO PREMIUM DUOTHERM / THERMO PRIME DOOR FRAME ALUTHERM PRIME DOOR FRAME
- 3D-ADJUSTABLE HINGES WITH CAPS IN FITTING COLOURS
- WARM SILL
- FITTINGS SET WITH INSERT PROTECTION
- BERGEN ESCUTCHEONS WITH ALEX HANDLES
- CLASS 5 LOCK INSERTS, ONE KEY SYSTEM FOR THERMO PREMIUM DOORS

• INSERTS **INOX** **BLACK**

## EXTRA CHARGES

CUSTOM HEIGHT (THERMO PRIME)	2150 - 2200 mm	✓
AGH / AGHB DESIGN ONLY	2250 - 2300 mm	✓
AVAILABLE COLOURS: FRP, FDE, FDW, FKG, FKF	2350 - 2400 mm	✓
ALUTHERM PREMIUM DOOR FRAME (THERMO PREMIUM DOOR)	✓	ELECTRIC STRIKE WITH DAY / NIGHT FEATURE ✓
TWO-COLOUR DOOR	✓	AMSTERDAM / MONTREAL HANDHOLD 1500 mm, RECOMMENDED ELECTRIC STRIKE ✓
CLASS 6 LOCK INSERTS, ONE KEY SYSTEM	✓	AMSTERDAM / MONTREAL HANDHOLD 1000 mm, RECOMMENDED ELECTRIC STRIKE ✓
UPPER ESCUTCHEON PROTECTION (THERMO PREMIUM)	✓	AMSTERDAM / MONTREAL HANDHOLD 1500 mm WITH PUSHBUTTON, WITH DOOR LEAF ADJUSTMENT, ELECTRIC STRIKE REQUIRED ✓
KNOB-HANDLE	✓	AMSTERDAM / MONTREAL HANDHOLD 1000 mm WITH PUSHBUTTON, WITH DOOR LEAF ADJUSTMENT, ELECTRIC STRIKE REQUIRED ✓
REED SWITCH	✓	TEDEE SET ✓
SIZE 100E	✓	

\* FIXED ALUMINUM ILLUMINATORS - PAGES 88-89, FULL EQUIPMENT LIST - PAGES 94-99

## GLASS



GRAPHITE

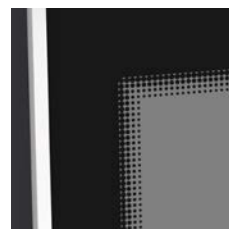

INOX

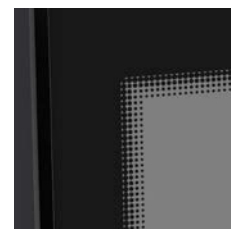

BLACK

## DOOR COLOURS

ALPINE WALNUT



FRR

MAHOGANY



FMA

BRAZILIAN WALNUT



FRB

LIGHT WALNUT



FRP

GOLD OAK



FDE

WINCHESTER



FDW

TURNER OAK



FDT

LIGHT WENGE



FEJ

WHITE



FSB

STEEL GRAY



FKZ

ANTHRACITE



FKG

DARK ANTHRACITE



FKF

BLACK



FKC



AGA SALZBURG

## THERMO PRIME 75 DOOR CONFIGURATION



INTERNAL SIDE

## INTERNAL SIDE

### FITTINGS

HANDLE-HANDLE



THERMO PRIME



THERMO PREMIUM

HANDLE-KNOB



THERMO PRIME



THERMO PREMIUM

HANDHOLD

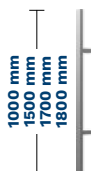

- AMSTERDAM
- MONTREAL

### FITTING COLOURS

PLATINUM ANODE



SILVER ANODE



BLACK ANODE



### DOOR COLOURS

ALPINE WALNUT



FRR

MAHOGANY



FMA

BRAZILIAN WALNUT



FRB

LIGHT WALNUT



FRP

GOLD OAK



FDE

WINCHESTER



FDW

TURNER OAK



FDT

LIGHT WENGE



FEJ

WHITE



FSB

STEEL GRAY



FKZ

ANTHRACITE



FKG

DARK ANTHRACITE



FKF

BLACK



FKC



**KWA PASAWA 1**



**KWB PASAWA 2**

SIZE	80	90N	90E	100E
------	----	-----	-----	------

MODEL	THERMO PREMIUM 60	THERMO PREMIUM 75	THERMO PRIME 75
<b>KWA / KWAB PASAWA 1</b>	✓	✓	✓
<b>KWB / KWBB PASAWA 2</b>	✓	✓	✓
<b>KWC / KWCB PASAWA 3</b>	✓	✓	✓
<b>KWD / KWDB PASAWA 4</b>	✓	✓	✓

### RC2 STANDARD EQUIPMENT

- GLAZED DOOR LEAF, COMPLIANT WITH THE "CLEAN AIR" PROGRAM TERMS
  - 4 DOOR LEAF UPSTANDS
  - THERMO PREMIUM DUOTHERM / THERMO PRIME DOOR FRAME ALUTHERM PRIME DOOR FRAME
  - 3D-ADJUSTABLE HINGES WITH CAPS IN FITTING COLOURS
  - WARM SILL
  - FITTINGS SET WITH INSERT PROTECTION
  - BERGEN ESCUTCHEONS WITH ALEX HANDLES
  - CLASS 5 LOCK INSERTS, ONE KEY SYSTEM FOR THERMO PREMIUM DOORS
- INSERTS **INOX** **BLACK**

### EXTRA CHARGES

CUSTOM HEIGHT (THERMO PRIME)	2150 - 2200 mm	✓
AVAILABLE COLOURS: FRP, FDE, FDW, FKG, FKF	2250 - 2300 mm	✓
	2350 - 2400 mm	✓
ALUTHERM PREMIUM DOOR FRAME (THERMO PREMIUM DOOR)	✓	HIDDEN SELF-CLOSING DEVICE (THERMO PREMIUM) ✓
TWO-COLOUR DOOR	✓	ELECTRIC STRIKE WITH DAY / NIGHT FEATURE ✓
CLASS 6 LOCK INSERTS, ONE KEY SYSTEM	✓	AMSTERDAM / MONTREAL HANDHOLD 1500 mm, RECOMMENDED ELECTRIC STRIKE ✓
UPPER ESCUTCHEON PROTECTION (THERMO PREMIUM)	✓	AMSTERDAM / MONTREAL HANDHOLD 1000 mm, RECOMMENDED ELECTRIC STRIKE ✓
KNOB-HANDLE	✓	AMSTERDAM / MONTREAL HANDHOLD 1500 mm WITH PUSHBUTTON, WITH DOOR LEAF ADJUSTMENT, ELECTRIC STRIKE REQUIRED ✓
REED SWITCH	✓	AMSTERDAM / MONTREAL HANDHOLD 1000 mm WITH PUSHBUTTON, WITH DOOR LEAF ADJUSTMENT, ELECTRIC STRIKE REQUIRED ✓
SIZE 100E	✓	TEDEE SET ✓
		DOOR SHORTENING KWA, KWB, KWC (10, 20, 30, 40 mm), KWD (10, 20, 30, 40, 60, 80, 100 mm) ✓

\* FIXED ALUMINUM ILLUMINATORS - PAGES 88-89, FULL EQUIPMENT LIST - PAGES 94-99

### GLASS



**MATTE**



**MIRA STAR (MIRROR GLASS)**

### DOOR COLOURS

#### ALPINE WALNUT



**FRR**

#### MAHOGANY



**FMA**

#### BRAZILIAN WALNUT



**FRB**

#### LIGHT WALNUT



**FRP**

#### GOLD OAK



**FDE**

#### WINCHESTER



**FDW**

#### TURNER OAK



**FDT**

#### LIGHT WENGE



**FEJ**

#### WHITE



**FSB**

#### STEEL GRAY



**FKZ**

#### ANTHRACITE



**FKG**

#### DARK ANTHRACITE



**FKF**

#### BLACK



**FKC**





**KWCB PASAWA 3 B**



**KWD PASAWA 4**



**INTERNAL SIDE**

## THERMO PRIME 75 DOOR CONFIGURATION



**KWA PASAWA 1**



**INTERNAL SIDE**

### FITTINGS

HANDLE-HANDLE



**THERMO PRIME**



**THERMO PREMIUM**

HANDLE-KNOB



**THERMO PRIME**



**THERMO PREMIUM**

HANDHOLD



□ AMSTERDAM  
○ MONTREAL

FITTING COLOURS

**PLATINUM ANODE**



**SILVER ANODE**



**BLACK ANODE**



## DOOR COLOURS

**ALPINE WALNUT**



**FRR**

**MAHOGANY**



**FMA**

**BRAZILIAN WALNUT**



**FRB**

**LIGHT WALNUT**



**FRP**

**GOLD OAK**



**FDE**

**WINCHESTER**



**FDW**

**TURNER OAK**



**FDT**

**LIGHT WENGE**



**FEJ**

**WHITE**



**FSB**

**STEEL GRAY**



**FKZ**

**ANTHRACITE**



**FKG**

**DARK ANTHRACITE**



**FKF**

**BLACK**



**FKC**



**KW3 JENA 3**



**KW4 JENA 4**

SIZE	80	90N	90E	100E
------	----	-----	-----	------

MODEL	THERMO PREMIUM 60	THERMO PREMIUM 75	THERMO PRIME 75
<b>KW3 / KW3B JENA 3</b>	✓	✓	✓
<b>KW4 / KW4B JENA 4</b>	✓	✓	✓

## RC2 STANDARD EQUIPMENT

- GLAZED DOOR LEAF, COMPLIANT WITH THE "CLEAN AIR" PROGRAM TERMS
- 4 DOOR LEAF UPSTANDS
- THERMO PREMIUM DUOTHERM / THERMO PRIME DOOR FRAME ALUTHERM PRIME DOOR FRAME
- 3D-ADJUSTABLE HINGES WITH CAPS IN FITTING COLOURS
- WARM SILL
- FITTINGS SET WITH INSERT PROTECTION
- BERGEN ESCUTCHEONS WITH ALEX HANDLES
- CLASS 5 LOCK INSERTS, ONE KEY SYSTEM FOR THERMO PREMIUM DOORS

## EXTRA CHARGES

CUSTOM HEIGHT (THERMO PRIME)	2150 - 2200 mm	✓
AVAILABLE COLOURS: FRP, FDE, FDW, FKG, FKF	2250 - 2300 mm	✓
	2350 - 2400 mm	✓
ALUTHERM PREMIUM DOOR FRAME (THERMO PREMIUM DOOR)	✓	HIDDEN SELF-CLOSING DEVICE (THERMO PREMIUM) ✓
TWO-COLOUR DOOR	✓	ELECTRIC STRIKE WITH DAY / NIGHT FEATURE ✓
CLASS 6 LOCK INSERTS, ONE KEY SYSTEM	✓	AMSTERDAM / MONTREAL HANDHOLD 1500 mm, RECOMMENDED ELECTRIC STRIKE ✓
UPPER ESCUTCHEON PROTECTION (THERMO PREMIUM)	✓	AMSTERDAM / MONTREAL HANDHOLD 1000 mm, RECOMMENDED ELECTRIC STRIKE ✓
KNOB-HANDLE	✓	AMSTERDAM / MONTREAL HANDHOLD 1500 mm WITH PUSHBUTTON, WITH DOOR LEAF ADJUSTMENT, ELECTRIC STRIKE REQUIRED ✓
REED SWITCH	✓	AMSTERDAM / MONTREAL HANDHOLD 1000 mm WITH PUSHBUTTON, WITH DOOR LEAF ADJUSTMENT, ELECTRIC STRIKE REQUIRED ✓
SIZE 100E	✓	TEDEE SET ✓
		DOOR SHORTENING (10, 20, 30, 40, 60, 80, 100 mm) ✓

\* FIXED ALUMINUM ILLUMINATORS - PAGES 88-89, FULL EQUIPMENT LIST - PAGES 94-99

## GLASS



**MATTE**



**MIRA STAR (MIRROR GLASS)**

## DOOR COLOURS

### ALPINE WALNUT



FRR

### MAHOGANY



FMA

### BRAZILIAN WALNUT



FRB

### LIGHT WALNUT



FRP

### GOLD OAK



FDE

### WINCHESTER



FDW

### TURNER OAK



FDT

### LIGHT WENGE



FEJ

### WHITE

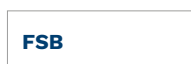

FSB

### STEEL GRAY



FKZ

### ANTHRACITE



FKG

### DARK ANTHRACITE



FKF

### BLACK



FKC



**KW3B JENA 3 B**

### THERMO PRIME 75 DOOR CONFIGURATION



**INTERNAL SIDE**

### INTERNAL SIDE

#### FITTINGS

HANDLE-HANDLE



**THERMO PRIME**



**THERMO PREMIUM**

HANDLE-KNOB



**THERMO PRIME**



**THERMO PREMIUM**

HANDHOLD



- AMSTERDAM**
- MONTREAL**

#### FITTING COLOURS

**PLATINUM ANODE**



**SILVER ANODE**



**BLACK ANODE**



#### DOOR COLOURS

**ALPINE WALNUT**



**FRR**

**MAHOGANY**



**FMA**

**BRAZILIAN WALNUT**



**FRB**

**LIGHT WALNUT**



**FRP**

**GOLD OAK**



**FDE**

**WINCHESTER**



**FDW**

**TURNER OAK**



**FDT**

**LIGHT WENGE**



**FEJ**

**WHITE**



**FSB**

**STEEL GRAY**



**FKZ**

**ANTHRACITE**



**FKG**

**DARK ANTHRACITE**



**FKF**

**BLACK**



**FKC**



**KWF BAMBERG 1**



**KWG BAMBERG 2**

SIZE	80	90N	90E	100E
------	----	-----	-----	------

MODEL	THERMO PREMIUM 60	THERMO PREMIUM 75	THERMO PRIME 75
<b>KWF / KWFB BAMBERG 1</b>	✓	✓	✓
<b>KWG / KWGB BAMBERG 2</b>	✓	✓	✓
<b>KWH / KWHB BAMBERG 3</b>	✓	✓	✓
<b>KWI / KWIB BAMBERG 4</b>	✓	✓	✓

## RC2 STANDARD EQUIPMENT

- GLAZED DOOR LEAF, COMPLIANT WITH THE "CLEAN AIR" PROGRAM TERMS
- 4 DOOR LEAF UPSTANDS
- THERMO PREMIUM DUOTHERM / THERMO PRIME DOOR FRAME ALUTHERM PRIME DOOR FRAME
- 3D-ADJUSTABLE HINGES WITH CAPS IN FITTING COLOURS
- WARM SILL
- FITTINGS SET WITH INSERT PROTECTION
- BERGEN ESCUTCHEONS WITH ALEX HANDLES
- CLASS 5 LOCK INSERTS, ONE KEY SYSTEM FOR THERMO PREMIUM DOORS

• INSERTS **INOX** **BLACK**

## EXTRA CHARGES

CUSTOM HEIGHT (THERMO PRIME)	2150 - 2200 mm	✓
AVAILABLE COLOURS: FRP, FDE, FDW, FKZ, FKJ	2250 - 2300 mm	✓
	2350 - 2400 mm	✓
ALUTHERM PREMIUM DOOR FRAME (THERMO PREMIUM DOOR)	✓	HIDDEN SELF-CLOSING DEVICE (THERMO PREMIUM) ✓
TWO-COLOUR DOOR	✓	ELECTRIC STRIKE WITH DAY / NIGHT FEATURE ✓
CLASS 6 LOCK INSERTS, ONE KEY SYSTEM	✓	AMSTERDAM / MONTREAL HANDHOLD 1500 mm, RECOMMENDED ELECTRIC STRIKE ✓
UPPER ESCUTCHEON PROTECTION (THERMO PREMIUM)	✓	AMSTERDAM / MONTREAL HANDHOLD 1000 mm, RECOMMENDED ELECTRIC STRIKE ✓
KNOB-HANDLE	✓	AMSTERDAM / MONTREAL HANDHOLD 1500 mm WITH PUSHBUTTON, WITH DOOR LEAF ADJUSTMENT, ELECTRIC STRIKE REQUIRED ✓
REED SWITCH	✓	AMSTERDAM / MONTREAL HANDHOLD 1000 mm WITH PUSHBUTTON, WITH DOOR LEAF ADJUSTMENT, ELECTRIC STRIKE REQUIRED ✓
SIZE 100E	✓	TEDEE SET ✓
		DOOR SHORTENING (10, 20, 30, 40 mm) ✓

\* FIXED ALUMINUM ILLUMINATORS - PAGES 88-89, FULL EQUIPMENT LIST - PAGES 94-99

## GLASS



**MATTE**



**MIRA STAR (MIRROR GLASS)**

## DOOR COLOURS

**ALPINE WALNUT**

**FRR**

**MAHOGANY**

**FMA**

**BRAZILIAN WALNUT**

**FRB**

**LIGHT WALNUT**

**FRP**

**GOLD OAK**

**FDE**

**WINCHESTER**

**FDW**

**TURNER OAK**

**FDT**

**LIGHT WENGE**

**FEJ**

**WHITE**

**FSB**

**STEEL GRAY**

**FKZ**

**ANTHRACITE**

**FKG**

**DARK ANTHRACITE**

**FKF**

**BLACK**

**FKC**



**KWHB BAMBERG 3 B**



**KWI BAMBERG 4**



**INTERNAL SIDE**

### THERMO PRIME 75 DOOR CONFIGURATION



**KWF BAMBERG 1**



**INTERNAL SIDE**

#### FITTINGS

HANDLE-HANDLE



**THERMO PRIME**



**THERMO PREMIUM**

HANDLE-KNOB



**THERMO PRIME**



**THERMO PREMIUM**

HANDHOLD



□ AMSTERDAM  
○ MONTREAL

FITTING COLOURS

**PLATINUM ANODE**



**SILVER ANODE**



**BLACK ANODE**



#### DOOR COLOURS

**ALPINE WALNUT**



**MAHOGANY**



**BRAZILIAN WALNUT**



**LIGHT WALNUT**



**GOLD OAK**



**WINCHESTER**



**TURNER OAK**



**LIGHT WENGE**



**WHITE**



**STEEL GRAY**



**ANTHRACITE**



**DARK ANTHRACITE**

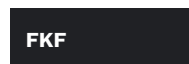

**BLACK**





**KWJB ULM 1 B**



**KWK ULM 2**

SIZE	80	90N	90E	100E
------	----	-----	-----	------

MODEL	THERMO PREMIUM 60	THERMO PREMIUM 75	THERMO PRIME 75
<b>KWJ / KWJB ULM 1</b>	✓	✓	-
<b>KWK / KWKB ULM 2</b>	✓	✓	✓

## RC2 STANDARD EQUIPMENT

- GLAZED DOOR LEAF, COMPLIANT WITH THE "CLEAN AIR" PROGRAM TERMS
- 4 DOOR LEAF UPSTANDS
- THERMO PREMIUM DUOTHERM / THERMO PRIME DOOR FRAME ALUTHERM PRIME DOOR FRAME
- 3D-ADJUSTABLE HINGES WITH CAPS IN FITTING COLOURS
- WARM SILL
- FITTINGS SET WITH INSERT PROTECTION
- BERGEN ESCUTCHEONS WITH ALEX HANDLES
- CLASS 5 LOCK INSERTS, ONE KEY SYSTEM FOR THERMO PREMIUM DOORS

• INSERTS **INOX** **BLACK**

## EXTRA CHARGES

CUSTOM HEIGHT (THERMO PRIME)	2150 - 2200 mm	✓
AVAILABLE COLOURS: FRP, FDE, FDW, FKG, FKF	2250 - 2300 mm	✓
	2350 - 2400 mm	✓
ALUTHERM PREMIUM DOOR FRAME (THERMO PREMIUM DOOR)	✓	HIDDEN SELF-CLOSING DEVICE (THERMO PREMIUM) ✓
TWO-COLOUR DOOR	✓	ELECTRIC STRIKE WITH DAY / NIGHT FEATURE ✓
CLASS 6 LOCK INSERTS, ONE KEY SYSTEM	✓	AMSTERDAM / MONTREAL HANDHOLD 1500 mm, RECOMMENDED ELECTRIC STRIKE ✓
UPPER ESCUTCHEON PROTECTION (THERMO PREMIUM)	✓	AMSTERDAM / MONTREAL HANDHOLD 1000 mm, RECOMMENDED ELECTRIC STRIKE ✓
KNOB-HANDLE	✓	AMSTERDAM / MONTREAL HANDHOLD 1500 mm WITH PUSHBUTTON, WITH DOOR LEAF ADJUSTMENT, ELECTRIC STRIKE REQUIRED ✓
REED SWITCH	✓	AMSTERDAM / MONTREAL HANDHOLD 1000 mm WITH PUSHBUTTON, WITH DOOR LEAF ADJUSTMENT, ELECTRIC STRIKE REQUIRED ✓
SIZE 100E	✓	TEDEE SET ✓
		DOOR SHORTENING (10, 20, 30, 40, 60, 80, 100 mm) ✓

\* FIXED ALUMINUM ILLUMINATORS - PAGES 88-89, FULL EQUIPMENT LIST - PAGES 94-99

## GLASS



**MATTE**



**MIRA STAR (MIRROR GLASS)**

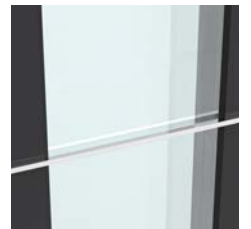

## DOOR COLOURS

**ALPINE WALNUT**



**FRR**

**MAHOGANY**



**FMA**

**BRAZILIAN WALNUT**



**FRB**

**LIGHT WALNUT**



**FRP**

**GOLD OAK**



**FDE**

**WINCHESTER**



**FDW**

**TURNER OAK**



**FDT**

**LIGHT WENGE**



**FEJ**

**WHITE**



**FSB**

**STEEL GRAY**



**FKZ**

**ANTHRACITE**



**FKG**

**DARK ANTHRACITE**



**FKF**

**BLACK**



**FKC**



**KWJ ULM 2**

## THERMO PRIME 75 DOOR CONFIGURATION



**INTERNAL SIDE**

## INTERNAL SIDE

### FITTINGS

HANDLE-HANDLE



**THERMO PRIME**



**THERMO PREMIUM**

HANDLE-KNOB



**THERMO PRIME**



**THERMO PREMIUM**

HANDHOLD

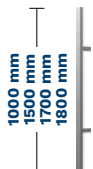

- AMSTERDAM**
- MONTREAL**

### FITTING COLOURS

**PLATINUM ANODE**



**SILVER ANODE**



**BLACK ANODE**



### DOOR COLOURS

**ALPINE WALNUT**



**FRR**

**MAHOGANY**



**FMA**

**BRAZILIAN WALNUT**



**FRB**

**LIGHT WALNUT**



**FRP**

**GOLD OAK**



**FDE**

**WINCHESTER**



**FDW**

**TURNER OAK**



**FDT**

**LIGHT WENGE**



**FEJ**

**WHITE**



**FSB**

**STEEL GRAY**



**FKZ**

**ANTHRACITE**



**FKG**

**DARK ANTHRACITE**



**FKF**

**BLACK**



**FKC**



**KWL TREWIR 1**



**KWMB TREWIR 2 B**

<b>SIZE</b>	80	90N	90E	100E
-------------	----	-----	-----	------

<b>MODEL</b>	<b>THERMO PREMIUM 60</b>	<b>THERMO PREMIUM 75</b>	<b>THERMO PRIME 75</b>
<b>KWL / KWL B TREWIR 1</b>	✓	✓	✓
<b>KWM / KWMB TREWIR 2</b>	✓	✓	✓
<b>KWN / KWNB TREWIR 3</b>	✓	✓	✓
<b>KWP / KWPB TREWIR 4</b>	✓	✓	✓
<b>KW7 / KW7B TREWIR 7</b>	✓	✓	✓

## RC2 STANDARD EQUIPMENT

- GLAZED DOOR LEAF, COMPLIANT WITH THE "CLEAN AIR" PROGRAM TERMS
- 4 DOOR LEAF UPSTANDS
- THERMO PREMIUM DUOTHERM / THERMO PRIME DOOR FRAME ALUTHERM PRIME DOOR FRAME
- 3D-ADJUSTABLE HINGES WITH CAPS IN FITTING COLOURS
- WARM SILL
- FITTINGS SET WITH INSERT PROTECTION
- BERGEN ESCUTCHEONS WITH ALEX HANDLES
- CLASS 5 LOCK INSERTS, ONE KEY SYSTEM FOR THERMO PREMIUM DOORS

- INSERTS **INOX** **BLACK**

## EXTRA CHARGES

CUSTOM HEIGHT (THERMO PRIME)	2150 - 2200 mm	✓
AVAILABLE COLOURS: FRP, FDE, FDW, FKG, FKF	2250 - 2300 mm	✓
	2350 - 2400 mm	✓
ALUTHERM PREMIUM DOOR FRAME (THERMO PREMIUM DOOR)	✓	HIDDEN SELF-CLOSING DEVICE (THERMO PREMIUM) ✓
TWO-COLOUR DOOR	✓	ELECTRIC STRIKE WITH DAY / NIGHT FEATURE ✓
CLASS 6 LOCK INSERTS, ONE KEY SYSTEM	✓	AMSTERDAM / MONTREAL HANDHOLD 1500 mm, RECOMMENDED ELECTRIC STRIKE ✓
UPPER ESCUTCHEON PROTECTION (THERMO PREMIUM)	✓	AMSTERDAM / MONTREAL HANDHOLD 1000 mm, RECOMMENDED ELECTRIC STRIKE ✓
KNOB-HANDLE	✓	AMSTERDAM / MONTREAL HANDHOLD 1500 mm WITH PUSHBUTTON, WITH DOOR LEAF ADJUSTMENT, ELECTRIC STRIKE REQUIRED ✓
REED SWITCH	✓	AMSTERDAM / MONTREAL HANDHOLD 1000 mm WITH PUSHBUTTON, WITH DOOR LEAF ADJUSTMENT, ELECTRIC STRIKE REQUIRED ✓
SIZE 100E	✓	TEDEE SET ✓
		DOOR SHORTENING (10, 20, 30, 40 mm) ✓

\* FIXED ALUMINUM ILLUMINATORS - PAGES 88-89, FULL EQUIPMENT LIST - PAGES 94-99

## GLASS



**MATTE**



**GRAPHITE**



**MIRA STAR (MIRROR GLASS)**

## DOOR COLOURS

### ALPINE WALNUT



**FRR**

### MAHOGANY



**FMA**

### BRAZILIAN WALNUT



**FRB**

### LIGHT WALNUT



**FRP**

### GOLD OAK



**FDE**

### WINCHESTER



**FDW**

### TURNER OAK



**FDT**

### LIGHT WENGE



**FEJ**

### WHITE



**FSB**

### STEEL GRAY



**FKZ**

### ANTHRACITE



**FKG**

### DARK ANTHRACITE



**FKF**

### BLACK



**FKC**





**KWN TREWIR 3**



**KWP TREWIR 4**



**KW7 TREWIR 7**

## THERMO PRIME 75 DOOR CONFIGURATION



**KWL TREWIR 1**



**INTERNAL SIDE**

### FITTINGS

#### HANDLE-HANDLE



**THERMO PRIME**



**THERMO PREMIUM**

#### HANDLE-KNOB



**THERMO PRIME**



**THERMO PREMIUM**

#### HANDHOLD



- AMSTERDAM
- MONTREAL

### FITTING COLOURS

#### PLATINUM ANODE



#### SILVER ANODE



#### BLACK ANODE



### DOOR COLOURS

#### ALPINE WALNUT



FRR

#### MAHOGANY



FMA

#### BRAZILIAN WALNUT



FRB

#### LIGHT WALNUT



FRP

#### GOLD OAK



FDE

#### WINCHESTER



FDW

#### TURNER OAK



FDT

#### LIGHT WENGE



FEJ

#### WHITE

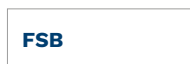

FSB

#### STEEL GRAY



FKZ

#### ANTHRACITE



FKG

#### DARK ANTHRACITE

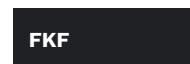

FKF

#### BLACK



FKC



**KWSB DORFEN B**

<b>SIZE</b>	80	90N	90E	100E
-------------	----	-----	-----	------

<b>MODEL</b>	<b>THERMO PREMIUM 60</b>	<b>THERMO PREMIUM 75</b>	<b>THERMO PRIME 75</b>
<b>KWS / KWSB DORFEN</b>	✓	✓	✓

## RC2 STANDARD EQUIPMENT

<ul style="list-style-type: none"> <li>GLAZED DOOR LEAF, COMPLIANT WITH THE "CLEAN AIR" PROGRAM TERMS</li> <li>4 DOOR LEAF UPSTANDS</li> <li>THERMO PREMIUM DUOTHERM / THERMO PRIME DOOR FRAME ALUTHERM PRIME DOOR FRAME</li> <li>3D-ADJUSTABLE HINGES WITH CAPS IN FITTING COLOURS</li> </ul>	<ul style="list-style-type: none"> <li>WARM SILL</li> <li>FITTINGS SET WITH INSERT PROTECTION</li> <li>BERGEN ESCUTCHEONS WITH ALEX HANDLES</li> <li>CLASS 5 LOCK INSERTS, ONE KEY SYSTEM FOR THERMO PREMIUM DOORS</li> </ul>
<ul style="list-style-type: none"> <li>INSERTS <b>INOX</b> <b>BLACK</b></li> </ul>	

## EXTRA CHARGES

CUSTOM HEIGHT (THERMO PRIME)	2150 - 2200 mm	✓
AVAILABLE COLOURS: FRP, FDE, FDW, FKG, FKF	2250 - 2300 mm	✓
	2350 - 2400 mm	✓
ALUTHERM PREMIUM DOOR FRAME (THERMO PREMIUM DOOR)	✓	HIDDEN SELF-CLOSING DEVICE (THERMO PREMIUM) ✓
TWO-COLOUR DOOR	✓	ELECTRIC STRIKE WITH DAY / NIGHT FEATURE ✓
CLASS 6 LOCK INSERTS, ONE KEY SYSTEM	✓	AMSTERDAM / MONTREAL HANDHOLD 1500 mm, RECOMMENDED ELECTRIC STRIKE ✓
UPPER ESCUTCHEON PROTECTION (THERMO PREMIUM)	✓	AMSTERDAM / MONTREAL HANDHOLD 1000 mm, RECOMMENDED ELECTRIC STRIKE ✓
KNOB-HANDLE	✓	AMSTERDAM / MONTREAL HANDHOLD 1500 mm WITH PUSHBUTTON, WITH DOOR LEAF ADJUSTMENT, ELECTRIC STRIKE REQUIRED ✓
REED SWITCH	✓	AMSTERDAM / MONTREAL HANDHOLD 1000 mm WITH PUSHBUTTON, WITH DOOR LEAF ADJUSTMENT, ELECTRIC STRIKE REQUIRED ✓
SIZE 100E	✓	TEDEE SET ✓
		DOOR SHORTENING (10, 20, 30, 40 mm) ✓

\* FIXED ALUMINUM ILLUMINATORS - PAGES 88-89, FULL EQUIPMENT LIST - PAGES 94-99

## GLASS



**MATTE**

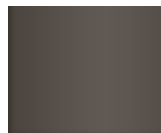

**GRAPHITE**



**MIRA STAR (MIRROR GLASS)**

## DOOR COLOURS

### ALPINE WALNUT



**FRR**

### MAHOGANY



**FMA**

### BRAZILIAN WALNUT



**FRB**

### LIGHT WALNUT



**FRP**

### GOLD OAK



**FDE**

### WINCHESTER



**FDW**

### TURNER OAK



**FDT**

### LIGHT WENGE



**FEJ**

### WHITE



**FSB**

### STEEL GRAY



**FKZ**

### ANTHRACITE



**FKG**

### DARK ANTHRACITE

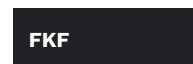

**FKF**

### BLACK



**FKC**



**KWS DORFEN**

## THERMO PRIME 75 DOOR CONFIGURATION



**INTERNAL SIDE**

## INTERNAL SIDE

### FITTINGS

HANDLE-HANDLE



**THERMO PRIME**



**THERMO PREMIUM**

HANDLE-KNOB



**THERMO PRIME**



**THERMO PREMIUM**

HANDHOLD



- AMSTERDAM**
- MONTREAL**

### FITTING COLOURS

**PLATINUM ANODE**



**SILVER ANODE**



**BLACK ANODE**



### DOOR COLOURS

**ALPINE WALNUT**



**FRR**

**MAHOGANY**



**FMA**

**BRAZILIAN WALNUT**



**FRB**

**LIGHT WALNUT**



**FRP**

**GOLD OAK**



**FDE**

**WINCHESTER**



**FDW**

**TURNER OAK**



**FDT**

**LIGHT WENGE**



**FEJ**

**WHITE**



**FSB**

**STEEL GRAY**



**FKZ**

**ANTHRACITE**



**FKG**

**DARK ANTHRACITE**



**FKF**

**BLACK**



**FKC**



**KWT KASSEL 1**



**KWXB KASSEL 2 B**

<b>SIZE</b>	80	90N	90E	100E
-------------	----	-----	-----	------

<b>MODEL</b>	<b>THERMO PREMIUM 60</b>	<b>THERMO PREMIUM 75</b>	<b>THERMO PRIME 75</b>
<b>KWT / KWTB KASSEL 1</b>	✓	✓	✓
<b>KWX / KWXB KASSEL 2</b>	✓	✓	✓

## RC2 STANDARD EQUIPMENT

- GLAZED DOOR LEAF, COMPLIANT WITH THE "CLEAN AIR" PROGRAM TERMS
- 4 DOOR LEAF UPSTANDS
- THERMO PREMIUM DUOTHERM / THERMO PRIME DOOR FRAME ALUTHERM PRIME DOOR FRAME
- 3D-ADJUSTABLE HINGES WITH CAPS IN FITTING COLOURS
- WARM SILL
- FITTINGS SET WITH INSERT PROTECTION
- BERGEN ESCUTCHEONS WITH ALEX HANDLES
- CLASS 5 LOCK INSERTS, ONE KEY SYSTEM FOR THERMO PREMIUM DOORS

- INSERTS **INOX** **BLACK**

## EXTRA CHARGES

CUSTOM HEIGHT (THERMO PRIME)	2150 - 2200 mm	✓
AVAILABLE COLOURS: FRP, FDE, FDW, FKG, FKF	2250 - 2300 mm	✓
	2350 - 2400 mm	✓
ALUTHERM PREMIUM DOOR FRAME (THERMO PREMIUM DOOR)	✓	HIDDEN SELF-CLOSING DEVICE (THERMO PREMIUM) ✓
TWO-COLOUR DOOR	✓	ELECTRIC STRIKE WITH DAY / NIGHT FEATURE ✓
CLASS 6 LOCK INSERTS, ONE KEY SYSTEM	✓	AMSTERDAM / MONTREAL HANDHOLD 1500 mm, RECOMMENDED ELECTRIC STRIKE ✓
UPPER ESCUTCHEON PROTECTION (THERMO PREMIUM)	✓	AMSTERDAM / MONTREAL HANDHOLD 1000 mm, RECOMMENDED ELECTRIC STRIKE ✓
KNOB-HANDLE	✓	AMSTERDAM / MONTREAL HANDHOLD 1500 mm WITH PUSHBUTTON, WITH DOOR LEAF ADJUSTMENT, ELECTRIC STRIKE REQUIRED ✓
REED SWITCH	✓	AMSTERDAM / MONTREAL HANDHOLD 1000 mm WITH PUSHBUTTON, WITH DOOR LEAF ADJUSTMENT, ELECTRIC STRIKE REQUIRED ✓
SIZE 100E	✓	TEDEE SET ✓
		DOOR SHORTENING (10, 20, 30, 40 mm) ✓

\* FIXED ALUMINUM ILLUMINATORS - PAGES 88-89, FULL EQUIPMENT LIST - PAGES 94-99

## GLASS



**MATTE**



**GRAPHITE**



**MIRA STAR (MIRROR GLASS)**

## DOOR COLOURS

### ALPINE WALNUT



**FRR**

### MAHOGANY



**FMA**

### BRAZILIAN WALNUT



**FRB**

### LIGHT WALNUT



**FRP**

### GOLD OAK



**FDE**

### WINCHESTER



**FDW**

### TURNER OAK



**FDT**

### LIGHT WENGE



**FEJ**

### WHITE



**FSB**

### STEEL GRAY



**FKZ**

### ANTHRACITE



**FKG**

### DARK ANTHRACITE



**FKF**

### BLACK



**FKC**



**KWT KASSEL 1**

## THERMO PRIME 75 DOOR CONFIGURATION



**INTERNAL SIDE**

## INTERNAL SIDE

### FITTINGS

HANDLE-HANDLE



**THERMO PRIME**

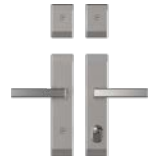

**THERMO PREMIUM**

HANDLE-KNOB



**THERMO PRIME**



**THERMO PREMIUM**

HANDHOLD



- AMSTERDAM**
- MONTREAL**

### FITTING COLOURS

**PLATINUM ANODE**



**SILVER ANODE**



**BLACK ANODE**



### DOOR COLOURS

**ALPINE WALNUT**



**FRR**

**MAHOGANY**



**FMA**

**BRAZILIAN WALNUT**



**FRB**

**LIGHT WALNUT**



**FRP**

**GOLD OAK**



**FDE**

**WINCHESTER**



**FDW**

**TURNER OAK**



**FDT**

**LIGHT WENGE**



**FEJ**

**WHITE**



**FSB**

**STEEL GRAY**



**FKZ**

**ANTHRACITE**



**FKG**

**DARK ANTHRACITE**

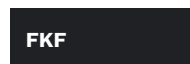

**FKF**

**BLACK**



**FKC**



**KPN KRONACH 1**



**KPPB KRONACH 2 B**

SIZE	80	90N	90E	100E
------	----	-----	-----	------

MODEL	THERMO PREMIUM 60	THERMO PREMIUM 75	THERMO PRIME 75
<b>KPN / KPNB KRONACH 1</b>	✓	✓	✓
<b>KPP / KPPB KRONACH 2</b>	✓	✓	✓
<b>KPT / KPTB KRONACH 3</b>	✓	✓	-
<b>KPZ / KPZB KRONACH 4</b>	✓	✓	-

## RC2 STANDARD EQUIPMENT

- DOOR LEAF, COMPLIANT WITH THE "CLEAN AIR" PROGRAM TERMS
- 4 DOOR LEAF UPSTANDS
- THERMO PREMIUM DUOTHERM / THERMO PRIME DOOR FRAME ALUTHERM PRIME DOOR FRAME
- 3D-ADJUSTABLE HINGES WITH CAPS IN FITTING COLOURS
- WARM SILL
- FITTINGS SET WITH INSERT PROTECTION
- BERGEN ESCUTCHEONS WITH ALEX HANDLES
- CLASS 5 LOCK INSERTS, ONE KEY SYSTEM FOR THERMO PREMIUM DOORS

- INSERTS **INOX** **BLACK**

## EXTRA CHARGES

CUSTOM HEIGHT (THERMO PRIME)	2150 - 2200 mm	✓
AVAILABLE COLOURS: FRP, FDE, FDW, FKG, FKF	2250 - 2300 mm	✓
	2350 - 2400 mm	✓
ALUTHERM PREMIUM DOOR FRAME (THERMO PREMIUM DOOR)	✓	HIDDEN SELF-CLOSING DEVICE (THERMO PREMIUM) ✓
TWO-COLOUR DOOR	✓	ELECTRIC STRIKE WITH DAY / NIGHT FEATURE ✓
RC3 PACKAGE	✓	AMSTERDAM / MONTREAL HANDHOLD 1500 mm, RECOMMENDED ELECTRIC STRIKE ✓
CLASS 6 LOCK INSERTS, ONE KEY SYSTEM	✓	AMSTERDAM / MONTREAL HANDHOLD 1000 mm, RECOMMENDED ELECTRIC STRIKE ✓
UPPER ESCUTCHEON PROTECTION (THERMO PREMIUM)	✓	AMSTERDAM / MONTREAL HANDHOLD 1500 mm WITH PUSHBUTTON, WITH DOOR LEAF ADJUSTMENT, ELECTRIC STRIKE REQUIRED ✓
KNOB-HANDLE	✓	AMSTERDAM / MONTREAL HANDHOLD 1000 mm WITH PUSHBUTTON, WITH DOOR LEAF ADJUSTMENT, ELECTRIC STRIKE REQUIRED ✓
REED SWITCH	✓	TEDEE SET ✓
INSERT AND APPLICATION - OPPOSITE SIDE	✓	DOOR SHORTENING (10, 20, 30, 40 mm) ✓
INSERT OTHER SIDE	✓	
SIZE 100E	✓	

\* FIXED ALUMINUM ILLUMINATORS - PAGES 88-89, FULL EQUIPMENT LIST - PAGES 94-99

## DOOR COLOURS

### ALPINE WALNUT



FRR

### MAHOGANY



FMA

### BRAZILIAN WALNUT



FRB

### LIGHT WALNUT



FRP

### GOLD OAK



FDE

### WINCHESTER



FDW

### TURNER OAK



FDT

### LIGHT WENGE



FEJ

### WHITE



FSB

### STEEL GRAY



FKZ

### ANTHRACITE



FKG

### DARK ANTHRACITE



FKF

### BLACK



FKC



**KPT KRONACH 3**



**KPZ KRONACH 4**



**INTERNAL SIDE**

## THERMO PRIME 75 DOOR CONFIGURATION



**KPN KRONACH 1**



**INTERNAL SIDE**

### FITTINGS

HANDLE-HANDLE



**THERMO PRIME**



**THERMO PREMIUM**

HANDLE-KNOB



**THERMO PRIME**



**THERMO PREMIUM**

HANDHOLD



□ AMSTERDAM  
○ MONTREAL

FITTING COLOURS

**PLATINUM ANODE**



**SILVER ANODE**



**BLACK ANODE**



## DOOR COLOURS

**ALPINE WALNUT**



**FRR**

**MAHOGANY**



**FMA**

**BRAZILIAN WALNUT**



**FRB**

**LIGHT WALNUT**



**FRP**

**GOLD OAK**



**FDE**

**WINCHESTER**



**FDW**

**TURNER OAK**



**FDT**

**LIGHT WENGE**



**FEJ**

**WHITE**



**FSB**

**STEEL GRAY**



**FKZ**

**ANTHRACITE**



**FKG**

**DARK ANTHRACITE**



**FKF**

**BLACK**



**FKC**



**KPJ REGEN 1**



**KPK REGEN 2**

<b>SIZE</b>	80	90N	90E	100E
-------------	----	-----	-----	------

<b>MODEL</b>	<b>THERMO PREMIUM 60</b>	<b>THERMO PREMIUM 75</b>	<b>THERMO PRIME 75</b>
<b>KPJ / KPJB REGEN 1</b>	✓	✓	✓
<b>KPK / KPKB REGEN 2</b>	✓	✓	✓
<b>KPL / KPLB REGEN 3</b>	✓	✓	✓
<b>KPS / KPSB REGEN 4</b>	✓	✓	✓
<b>KPM / KPMB REGEN 5</b>	✓	✓	✓
<b>KPR / KPRB REGEN 6</b>	✓	✓	✓

## RC2 STANDARD EQUIPMENT

- DOOR LEAF, COMPLIANT WITH THE "CLEAN AIR" PROGRAM TERMS
  - 4 DOOR LEAF UPSTANDS
  - THERMO PREMIUM DUOTHERM / THERMO PRIME DOOR FRAME ALUTHERM PRIME DOOR FRAME
  - 3D-ADJUSTABLE HINGES WITH CAPS IN FITTING COLOURS
  - WARM SILL
  - FITTINGS SET WITH INSERT PROTECTION
  - BERGEN ESCUTCHEONS WITH ALEX HANDLES
  - CLASS 5 LOCK INSERTS, ONE KEY SYSTEM FOR THERMO PREMIUM DOORS
- INSERTS **INOX** **BLACK**

## EXTRA CHARGES

CUSTOM HEIGHT (THERMO PRIME)	2150 - 2200 mm	✓
AVAILABLE COLOURS: FRP, FDE, FDW, FKG, FKF	2250 - 2300 mm	✓
	2350 - 2400 mm	✓
ALUTHERM PREMIUM DOOR FRAME (THERMO PREMIUM DOOR)	✓	HIDDEN SELF-CLOSING DEVICE (THERMO PREMIUM) ✓
TWO-COLOUR DOOR	✓	ELECTRIC STRIKE WITH DAY / NIGHT FEATURE ✓
RC3 PACKAGE	✓	AMSTERDAM / MONTREAL HANDHOLD 1500 mm, RECOMMENDED ELECTRIC STRIKE ✓
CLASS 6 LOCK INSERTS, ONE KEY SYSTEM	✓	AMSTERDAM / MONTREAL HANDHOLD 1000 mm, RECOMMENDED ELECTRIC STRIKE ✓
UPPER ESCUTCHEON PROTECTION (THERMO PREMIUM)	✓	AMSTERDAM / MONTREAL HANDHOLD 1500 mm WITH PUSHBUTTON, WITH DOOR LEAF ADJUSTMENT, ELECTRIC STRIKE REQUIRED ✓
KNOB-HANDLE	✓	AMSTERDAM / MONTREAL HANDHOLD 1000 mm WITH PUSHBUTTON, WITH DOOR LEAF ADJUSTMENT, ELECTRIC STRIKE REQUIRED ✓
REED SWITCH	✓	TEDEE SET ✓
INSERT AND APPLICATION - OPPOSITE SIDE	✓	DOOR SHORTENING (10, 20, 30, 40 mm) ✓
INSERT OTHER SIDE	✓	
SIZE 100E	✓	

\* FIXED ALUMINUM ILLUMINATORS - PAGES 88-89, FULL EQUIPMENT LIST - PAGES 94-99

## DOOR COLOURS

### ALPINE WALNUT



FRR

### MAHOGANY



FMA

### BRAZILIAN WALNUT



FRB

### LIGHT WALNUT



FRP

### GOLD OAK



FDE

### WINCHESTER



FDW

### TURNER OAK



FDT

### LIGHT WENGE



FEJ

### WHITE

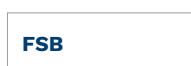

FSB

### STEEL GRAY



FKZ

### ANTHRACITE



FKG

### DARK ANTHRACITE



FKF

### BLACK



FKC





KPL REGEN 3



KPS REGEN 4



KPM REGEN 5

## THERMO PRIME 75 DOOR CONFIGURATION



KPRB REGEN 6 B



KPJ REGEN 1



INTERNAL SIDE

### FITTINGS

HANDLE-HANDLE



THERMO PRIME



THERMO PREMIUM

HANDLE-KNOB



THERMO PRIME



THERMO PREMIUM

HANDHOLD



□ AMSTERDAM  
○ MONTREAL

FITTING COLOURS

PLATINUM ANODE



SILVER ANODE



BLACK ANODE



### DOOR COLOURS

ALPINE WALNUT



MAHOGANY



BRAZILIAN WALNUT



LIGHT WALNUT



GOLD OAK



WINCHESTER



TURNER OAK



LIGHT WENGE



WHITE



STEEL GRAY



ANTHRACITE



DARK ANTHRACITE



BLACK





**KPE DREZNO 1**



**KPFB DREZNO 2 B**

SIZE	80	90N	90E	100E
------	----	-----	-----	------

MODEL	THERMO PREMIUM 60	THERMO PREMIUM 75	THERMO PRIME 75
<b>KPE / KPEB DREZNO 1</b>	✓	✓	-
<b>KPF / KPFB DREZNO 2</b>	✓	✓	-
<b>KPH / KPFB DREZNO 4</b>	✓	✓	✓

### RC2 STANDARD EQUIPMENT

- DOOR LEAF, COMPLIANT WITH THE "CLEAN AIR" PROGRAM TERMS
- 4 DOOR LEAF UPSTANDS
- THERMO PREMIUM DUOTHERM / THERMO PRIME DOOR FRAME ALUTHERM PRIME DOOR FRAME
- 3D-ADJUSTABLE HINGES WITH CAPS IN FITTING COLOURS
- WARM SILL
- FITTINGS SET WITH INSERT PROTECTION
- BERGEN ESCUTCHEONS WITH ALEX HANDLES
- CLASS 5 LOCK INSERTS, ONE KEY SYSTEM FOR THERMO PREMIUM DOORS

- INSERTS **INOX** **BLACK**

### EXTRA CHARGES

CUSTOM HEIGHT (THERMO PRIME)	2150 - 2200 mm	✓
AVAILABLE COLOURS: FRP, FDE, FDW, FKG, FKF	2250 - 2300 mm	✓
	2350 - 2400 mm	✓
ALUTHERM PREMIUM DOOR FRAME (THERMO PREMIUM DOOR)	✓	HIDDEN SELF-CLOSING DEVICE (THERMO PREMIUM) ✓
TWO-COLOUR DOOR	✓	ELECTRIC STRIKE WITH DAY / NIGHT FEATURE ✓
RC3 PACKAGE	✓	AMSTERDAM / MONTREAL HANDHOLD 1500 mm, RECOMMENDED ELECTRIC STRIKE ✓
CLASS 6 LOCK INSERTS, ONE KEY SYSTEM	✓	AMSTERDAM / MONTREAL HANDHOLD 1000 mm, RECOMMENDED ELECTRIC STRIKE ✓
UPPER ESCUTCHEON PROTECTION (THERMO PREMIUM)	✓	AMSTERDAM / MONTREAL HANDHOLD 1500 mm WITH PUSHBUTTON, WITH DOOR LEAF ADJUSTMENT, ELECTRIC STRIKE REQUIRED ✓
KNOB-HANDLE	✓	AMSTERDAM / MONTREAL HANDHOLD 1000 mm WITH PUSHBUTTON, WITH DOOR LEAF ADJUSTMENT, ELECTRIC STRIKE REQUIRED ✓
REED SWITCH	✓	TEDEE SET ✓
INSERT OTHER SIDE	✓	DOOR SHORTENING KPH (10, 20, 30, 40 mm), KPE, KPF, (10, 20, 30, 40, 60, 80, 100 mm) ✓
SIZE 100E	✓	

\* FIXED ALUMINUM ILLUMINATORS - PAGES 88-89, FULL EQUIPMENT LIST - PAGES 94-99

### DOOR COLOURS

ALPINE WALNUT



FRR

MAHOGANY



FMA

BRAZILIAN WALNUT



FRB

LIGHT WALNUT



FRP

GOLD OAK



FDE

WINCHESTER



FDW

TURNER OAK



FDT

LIGHT WENGE



FEJ

WHITE



FSB

STEEL GRAY



FKZ

ANTHRACITE



FKG

DARK ANTHRACITE



FKF

BLACK



FKC



**KPH DREZNO 4**



**INTERNAL SIDE**

### THERMO PRIME 75 DOOR CONFIGURATION



**KPE DREZNO 4**



**INTERNAL SIDE**

#### FITTINGS

HANDLE-HANDLE



**THERMO PRIME**



**THERMO PREMIUM**

HANDLE-KNOB



**THERMO PRIME**



**THERMO PREMIUM**

HANDHOLD



□ AMSTERDAM  
○ MONTREAL

FITTING COLOURS

**PLATINUM ANODE**



**SILVER ANODE**



**BLACK ANODE**



#### DOOR COLOURS

**ALPINE WALNUT**



**FRR**

**MAHOGANY**



**FMA**

**BRAZILIAN WALNUT**



**FRB**

**LIGHT WALNUT**



**FRP**

**GOLD OAK**



**FDE**

**WINCHESTER**



**FDW**

**TURNER OAK**



**FDT**

**LIGHT WENGE**



**FEJ**

**WHITE**



**FSB**

**STEEL GRAY**



**FKZ**

**ANTHRACITE**



**FKG**

**DARK ANTHRACITE**



**FKF**

**BLACK**



**FKC**



**KPAB ERFURT 1 B**



**KPB ERFURT 2**

SIZE	80	90N	90E	100E
------	----	-----	-----	------

MODEL	THERMO PREMIUM 60	THERMO PREMIUM 75	THERMO PRIME 75
<b>KPA / KPAB ERFURT 1</b>	✓	✓	✓
<b>KPB / KPBB ERFURT 2</b>	✓	✓	✓
<b>KPC / KPCB ERFURT 3</b>	✓	✓	✓

## RC2 STANDARD EQUIPMENT

- DOOR LEAF, COMPLIANT WITH THE "CLEAN AIR" PROGRAM TERMS
- 4 DOOR LEAF UPSTANDS
- THERMO PREMIUM DUOTHERM / THERMO PRIME DOOR FRAME ALUTHERM PRIME DOOR FRAME
- 3D-ADJUSTABLE HINGES WITH CAPS IN FITTING COLOURS
- INSERTS **INOX** **BLACK**
- WARM SILL
- FITTINGS SET WITH INSERT PROTECTION
- BERGEN ESCUTCHEONS WITH ALEX HANDLES
- CLASS 5 LOCK INSERTS, ONE KEY SYSTEM FOR THERMO PREMIUM DOORS

## EXTRA CHARGES

CUSTOM HEIGHT (THERMO PRIME)	2150 - 2200 mm	✓
AVAILABLE COLOURS: FRP, FDE, FDW, FKG, FKF	2250 - 2300 mm	✓
	2350 - 2400 mm	✓
ALUTHERM PREMIUM DOOR FRAME (THERMO PREMIUM DOOR)	✓	HIDDEN SELF-CLOSING DEVICE (THERMO PREMIUM) ✓
TWO-COLOUR DOOR	✓	ELECTRIC STRIKE WITH DAY / NIGHT FEATURE ✓
RC3 PACKAGE	✓	AMSTERDAM / MONTREAL HANDHOLD 1500 mm, RECOMMENDED ELECTRIC STRIKE ✓
CLASS 6 LOCK INSERTS, ONE KEY SYSTEM	✓	AMSTERDAM / MONTREAL HANDHOLD 1000 mm, RECOMMENDED ELECTRIC STRIKE ✓
UPPER ESCUTCHEON PROTECTION (THERMO PREMIUM)	✓	AMSTERDAM / MONTREAL HANDHOLD 1500 mm WITH PUSHBUTTON, WITH DOOR LEAF ADJUSTMENT, ELECTRIC STRIKE REQUIRED ✓
KNOB-HANDLE	✓	AMSTERDAM / MONTREAL HANDHOLD 1000 mm WITH PUSHBUTTON, WITH DOOR LEAF ADJUSTMENT, ELECTRIC STRIKE REQUIRED ✓
REED SWITCH	✓	TEDEE SET ✓
INSERT OTHER SIDE	✓	DOOR SHORTENING (10, 20, 30, 40 mm) ✓
SIZE 100E	✓	

\* FIXED ALUMINUM ILLUMINATORS - PAGES 88-89, FULL EQUIPMENT LIST - PAGES 94-99

## DOOR COLOURS

ALPINE WALNUT



FRR

MAHOGANY



FMA

BRAZILIAN WALNUT



FRB

LIGHT WALNUT



FRP

GOLD OAK



FDE

WINCHESTER



FDW

TURNER OAK



FDT

LIGHT WENGE



FEJ

WHITE



FSB

STEEL GRAY



FKZ

ANTHRACITE



FKG

DARK ANTHRACITE



FKF

BLACK



FKC



**KPC ERFURT 3**



**INTERNAL SIDE**

**THERMO PRIME 75 DOOR CONFIGURATION**



**KPA ERFURT 1**



**INTERNAL SIDE**

**FITTINGS**

HANDLE-HANDLE



**THERMO PRIME**



**THERMO PREMIUM**

HANDLE-KNOB



**THERMO PRIME**



**THERMO PREMIUM**

HANDHOLD



- AMSTERDAM**
- MONTREAL**

**FITTING COLOURS**

**PLATINUM ANODE**



**SILVER ANODE**



**BLACK ANODE**



**DOOR COLOURS**

**ALPINE WALNUT**



**MAHOGANY**



**BRAZILIAN WALNUT**



**LIGHT WALNUT**



**GOLD OAK**



**WINCHESTER**



**TURNER OAK**



**LIGHT WENGE**



**WHITE**



**STEEL GRAY**



**ANTHRACITE**



**DARK ANTHRACITE**



**BLACK**



# ELITE 3D

## BRIG / OLTEN / VISP / TRIN / BERNO



ELA BRIG



ELB OLTEN

SIZE	80	90N	90E	100E
------	----	-----	-----	------

MODEL	THERMO PREMIUM 60	THERMO PREMIUM 75	THERM PRIME 75
ELA BRIG	✓	✓	✓
ELB OLTEN	✓	✓	✓
ELC VISP	✓	✓	✓
ELD TRIN	✓	✓	✓
ELE BERNO	✓	✓	✓

### RC2 STANDARD EQUIPMENT

- DOOR LEAF, COMPLIANT WITH THE "CLEAN AIR" PROGRAM TERMS
- 4 DOOR LEAF UPSTANDS
- THERMO PREMIUM DUOTHERM / THERMO PRIME DOOR FRAME ALUTHERM PRIME DOOR FRAME
- 3D-ADJUSTABLE HINGES WITH CAPS IN FITTING COLOURS
- WARM SILL
- FITTINGS SET WITH INSERT PROTECTION
- BERGEN ESCUTCHEONS WITH ALEX HANDLES
- CLASS 5 LOCK INSERTS, ONE KEY SYSTEM FOR THERMO PREMIUM DOORS

### EXTRA CHARGES

CUSTOM HEIGHT (THERMO PRIME)		2150 - 2200 mm	✓
AVAILABLE COLOURS: FRP, FDE, FDW, FKG, FKF		2250 - 2300 mm	✓
		2350 - 2400 mm	✓
ALUTHERM PREMIUM DOOR FRAME (THERMO PREMIUM DOOR)	✓	HIDDEN SELF-CLOSING DEVICE (THERMO PREMIUM)	✓
SIZE 100E	✓	ELECTRIC STRIKE WITH DAY / NIGHT FEATURE	✓
TWO-COLOUR DOOR	✓	TEDEE SET	✓
RC3 PACKAGE	✓	DOOR SHORTENING (10, 20, 30, 40 mm)	✓
CLASS 6 LOCK INSERTS, ONE KEY SYSTEM	✓		
UPPER ESCUTCHEON PROTECTION	✓		
KNOB-HANDLE	✓		
REED SWITCH	✓		
FRAME OTHER SIDE	✓		

\* FIXED ALUMINUM ILLUMINATORS - PAGES 88-89, FULL EQUIPMENT LIST - PAGES 94-99

### INSERT



CLASSIC



MODERN



### DOOR COLOURS

#### ALPINE WALNUT



FRR

#### MAHOGANY



FMA

#### BRAZILIAN WALNUT



FRB

#### LIGHT WALNUT



FRP

#### GOLD OAK



FDE

#### WINCHESTER



FDW

#### TURNER OAK



FDT

#### LIGHT WENGE



FEJ

#### WHITE

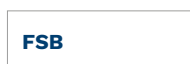

FSB

#### STEEL GRAY



FKZ

#### ANTHRACITE



FKG

#### DARK ANTHRACITE



FKF

#### BLACK



FKC

# GERDA® ELITE 3D BRIG / OLTEN / VISP / TRIN / BERNO



ELC VISP



ELD TRIN



ELE BERNO

## THERMO PRIME 75 DOOR CONFIGURATION



ELA BRIG



INTERNAL SIDE

### FITTINGS

HANDLE-HANDLE



THERMO PRIME



THERMO PREMIUM

HANDLE-KNOB



THERMO PRIME



THERMO PREMIUM

### FITTING COLOURS

PLATINUM ANODE



SILVER ANODE



BLACK ANODE



### DOOR COLOURS

ALPINE WALNUT



FRR

MAHOGANY



FMA

BRAZILIAN WALNUT



FRB

LIGHT WALNUT



FRP

GOLD OAK



FDE

WINCHESTER



FDW

TURNER OAK



FDT

LIGHT WENGE



FEJ

WHITE



FSB

STEEL GRAY



FKZ

ANTHRACITE



FKG

DARK ANTHRACITE



FKF

BLACK



FKC



NS1B MILANO 8 B



NS2 MILANO 9

SIZE (THERMO PRIME, THERMO PREMIUM)	-	80	90N	90E	100E
SIZE OPTIMA	80N	80	90N	90E	100E

MODEL	OPTIMA 60	THERMO PREMIUM 60	THERMO PREMIUM 75	THERMO PRIME 75
NS1/NS1B MILANO 8	✓	✓	✓	✓
NS2/NS2B MILANO 9	✓	✓	✓	✓
NS3/NS3B MILANO 10	✓	✓	✓	✓
NS4/NS4B MILANO 11	✓	✓	✓	✓
NS9/NS9B MILANO 12	✓	✓	✓	✓

## RC2 STANDARD EQUIPMENT

- GLAZED DOOR LEAF, COMPLIANT WITH THE "CLEAN AIR" PROGRAM TERMS
- ALUMINUM SILL
- 4 DOOR LEAF UPSTANDS THERMO PREMIUM AND THERMO PRIME, 3 DOOR LEAF UPSTANDS OPTIMA
- FITTINGS SET WITH INSERT PROTECTION
- THERMO PREMIUM DUOTHERM / THERMO PRIME DOOR FRAME ALUTHERM PRIME DOOR FRAME / OPTIMA ERFOOTHERM DOOR FRAME
- BERGEN THERMO PREMIUM LONG ESCUTCHEONS, BERGEN THERMO PRIME SPLIT ESCUTCHEONS, BLOK OPTIMA SPLIT ESCUTCHEON
- 3D-ADJUSTABLE HINGES WITH CAPS IN FITTING COLOURS THERMO PREMIUM AND THERMO PRIME, 2D HINGE WITH CAPS IN FITTING COLOURS OPTIMA
- CLASS 5 LOCK INSERTS, ONE KEY SYSTEM FOR THERMO PREMIUM AND OPTIMA DOORS
- DOUBLE-SIDED PATTERN

## EXTRA CHARGES

CUSTOM HEIGHT (THERMO PRIME)	2150 - 2200 mm	✓
AVAILABLE COLOURS: FRP, FDE, FDW, FKG, FKF	2250 - 2300 mm	✓
	2350 - 2400 mm	✓
ALUTHERM PREMIUM DOOR FRAME (THERMO PREMIUM DOOR) / ALUTHERM (OPTIMA 60)	✓	HIDDEN SELF-CLOSING DEVICE (THERMO PREMIUM) ✓
TWO-COLOUR DOOR	✓	ELECTRIC STRIKE WITH DAY / NIGHT FEATURE ✓
CLASS 6 LOCK INSERTS, ONE KEY SYSTEM	✓	AMSTERDAM / MONTREAL HANDHOLD 1500 mm, RECOMMENDED ELECTRIC STRIKE ✓
UPPER ESCUTCHEON PROTECTION (THERMO PREMIUM)	✓	AMSTERDAM / MONTREAL HANDHOLD 1000 mm, RECOMMENDED ELECTRIC STRIKE ✓
KNOB-HANDLE	✓	AMSTERDAM / MONTREAL HANDHOLD 1500 mm WITH PUSHBUTTON, WITH DOOR LEAF ADJUSTMENT, ELECTRIC STRIKE REQUIRED ✓
REED SWITCH	✓	AMSTERDAM / MONTREAL HANDHOLD 1000 mm WITH PUSHBUTTON, WITH DOOR LEAF ADJUSTMENT, ELECTRIC STRIKE REQUIRED ✓
SIZE 100E	✓	TEDEE SET ✓
	✓	DOOR SHORTENING NS1, NS2, NS3, NS9 (10, 20, 30, 40 mm), NS4 (10, 20, 30, 40, 60, 80, 100 mm) ✓

\* FIXED ALUMINUM ILLUMINATORS - PAGES 88-89, FULL EQUIPMENT LIST - PAGES 94-99

## GLASS



MATTE

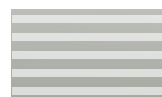

MATTE, SEE-THROUGH STRIPS



MIRA STAR (MIRROR GLASS)

## DOOR COLOURS

### ALPINE WALNUT



FRR

### MAHOGANY



FMA

### BRAZILIAN WALNUT



FRB

### LIGHT WALNUT



FRP

### GOLD OAK



FDE

### WINCHESTER



FDW

### TURNER OAK



FDT

### LIGHT WENGE



FEJ

### WHITE



FSB

### STEEL GRAY



FKZ

### ANTHRACITE



FKG

### DARK ANTHRACITE



FKF

### BLACK



FKC





NS3 MILANO 10



NS4 MILANO 11



NS9 MILANO 12

### THERMO PRIME 75 DOOR CONFIGURATION



NS1B MILANO 8 B



INTERNAL SIDE

#### FITTINGS

HANDLE-HANDLE



**THERMO PRIME**



**THERMO PREMIUM**



**OPTIMA**

HANDLE-KNOB



**THERMO PREMIUM**

HANDHOLD

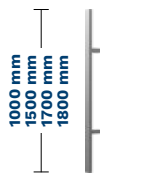

□ **AMSTERDAM**

○ **MONTREAL**

FITTING COLOURS

**PLATINUM ANODE**



**SILVER ANODE**



**BLACK ANODE**



### DOOR COLOURS

**ALPINE WALNUT**



FRR

**MAHOGANY**



FMA

**BRAZILIAN WALNUT**



FRB

**LIGHT WALNUT**



FRP

**GOLD OAK**



FDE

**WINCHESTER**



FDW

**TURNER OAK**



FDT

**LIGHT WENGE**



FEJ

**WHITE**



FSB

**STEEL GRAY**



FKZ

**ANTHRACITE**



FKG

**DARK ANTHRACITE**



FKF

**BLACK**



FKC

# TEMPO HANOVER / INNSBRUCK



NS5B HANOVER 5 B



NS6 HANOVER 6

SIZE (THERMO PRIME, THERMO PREMIUM)	-	80	90N	90E	100E
SIZE OPTIMA	80N	80	90N	90E	100E

MODEL	OPTIMA 60	THERMO PREMIUM 60	THERMO PREMIUM 75	THERMO PRIME 75
NS5 HANOVER 5 B	✓	✓	✓	✓
NS6 HANOVER 6	✓	✓	✓	✓
NS7 INNSBRUCK	✓	✓	✓	✓

## RC2 STANDARD EQUIPMENT

- GLAZED DOOR LEAF, COMPLIANT WITH THE "CLEAN AIR" PROGRAM TERMS
- 4 DOOR LEAF UPSTANDS THERMO PREMIUM AND THERMO PRIME, 3 DOOR LEAF UPSTANDS OPTIMA
- THERMO PREMIUM DUOTHERM / THERMO PRIME DOOR FRAME ALUTHERM PRIME DOOR FRAME / OPTIMA DOOR FRAME PERFOTHERM
- 3D-ADJUSTABLE HINGES WITH CAPS IN FITTING COLOURS THERMO PREMIUM AND THERMO PRIME, 2D HINGE WITH CAPS IN FITTING COLOURS OPTIMA
- DOUBLE-SIDED PATTERN
- ALUMINUM SILL
- FITTINGS SET WITH INSERT PROTECTION
- BERGEN THERMO PREMIUM LONG ESCUTCHEONS, BERGEN THERMO PRIME SPLIT ESCUTCHEONS, BLOK OPTIMA SPLIT ESCUTCHEON
- CLASS 5 LOCK INSERTS, ONE KEY SYSTEM FOR THERMO PREMIUM AND OPTIMA DOORS

## EXTRA CHARGES

CUSTOM HEIGHT (THERMO PRIME)	2150 - 2200 mm	✓
AVAILABLE COLOURS: FRP, FDE, FDW, FKG, FKF	2250 - 2300 mm	✓
	2350 - 2400 mm	✓
ALUTHERM PREMIUM DOOR FRAME (THERMO PREMIUM DOOR) / ALUTHERM (OPTIMA 60)	✓	HIDDEN SELF-CLOSING DEVICE (THERMO PREMIUM) ✓
TWO-COLOUR DOOR	✓	ELECTRIC STRIKE WITH DAY / NIGHT FEATURE ✓
CLASS 6 LOCK INSERTS, ONE KEY SYSTEM	✓	AMSTERDAM / MONTREAL HANDHOLD 1500 mm, RECOMMENDED ELECTRIC STRIKE ✓
UPPER ESCUTCHEON PROTECTION (THERMO PREMIUM)	✓	AMSTERDAM / MONTREAL HANDHOLD 1000 mm, RECOMMENDED ELECTRIC STRIKE ✓
KNOB-HANDLE	✓	AMSTERDAM / MONTREAL HANDHOLD 1500 mm WITH PUSHBUTTON, WITH DOOR LEAF ADJUSTMENT, ELECTRIC STRIKE REQUIRED ✓
REED SWITCH	✓	AMSTERDAM / MONTREAL HANDHOLD 1000 mm WITH PUSHBUTTON, WITH DOOR LEAF ADJUSTMENT, ELECTRIC STRIKE REQUIRED ✓
SIZE 100E	✓	TEDEE SET ✓
	✓	DOOR SHORTENING NS5 (10, 20, 30, 40, 60, 80, 100 mm), NS6 (10, 20, 30, 40 mm) ✓

\* FIXED ALUMINUM ILLUMINATORS - PAGES 88-89, FULL EQUIPMENT LIST - PAGES 94-99

## GLASS



MATTE



MIRA STAR (MIRROR GLASS)

## DOOR COLOURS

ALPINE WALNUT



FRR

MAHOGANY



FMA

BRAZILIAN WALNUT



FRB

LIGHT WALNUT



FRP

GOLD OAK



FDE

WINCHESTER



FDW

TURNER OAK



FDT

LIGHT WENGE



FEJ

WHITE

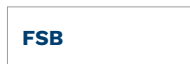

FSB

STEEL GRAY



FKZ

ANTHRACITE



FKG

DARK ANTHRACITE



FKF

BLACK



FKC



NS7 INNSBRUCK

### THERMO PRIME 75 DOOR CONFIGURATION



NS5B HANOVER 5 B



INTERNAL SIDE

#### FITTINGS

HANDLE-HANDLE



**THERMO PRIME**



**THERMO PREMIUM**



**OPTIMA**

HANDLE-KNOB



**THERMO PREMIUM**

HANDHOLD

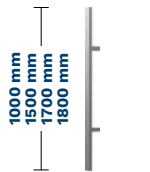

□ **AMSTERDAM**  
○ **MONTREAL**

FITTING COLOURS

**PLATINUM ANODE**



**SILVER ANODE**



**BLACK ANODE**



#### DOOR COLOURS

ALPINE WALNUT



MAHOGANY



BRAZILIAN WALNUT



LIGHT WALNUT



GOLD OAK



WINCHESTER



TURNER OAK



LIGHT WENGE



WHITE



STEEL GRAY



ANTHRACITE



DARK ANTHRACITE



BLACK





**W00 FLAT**

<b>SIZE (THERMO PRIME, THERMO PREMIUM)</b>	-	80	90N	90E	100E
<b>SIZE OPTIMA</b>	80N	80	90N	90E	100E

MODEL	OPTIMA 50	OPTIMA 60	THERMO PREMIUM 60	THERMO PREMIUM 75	THERMO PRIME 75
<b>W00 FLAT</b>	✓	✓	✓	✓	✓

## RC2 STANDARD EQUIPMENT

- DOOR LEAF COMPLIANT WITH THE "CLEAN AIR" PROGRAM TERMS
- ALUMINUM SILL
- 4 DOOR LEAF UPSTANDS THERMO PREMIUM AND THERMO PRIME, 3 DOOR LEAF UPSTANDS OPTIMA
- FITTINGS SET WITH INSERT PROTECTION
- THERMO PREMIUM DOOR FRAME DUOTHERM / THERMO PRIME DOOR FRAME ALUTHERM PRIME / OPTIMA 60 PERFOTHERM / OPTIMA 50 STEEL DOOR FRAME
- BERGEN THERMO PREMIUM LONG ESCUTCHEONS, BERGEN THERMO PRIME SPLIT ESCUTCHEONS, BLOK OPTIMA SPLIT ESCUTCHEON
- 3D-ADJUSTABLE HINGES WITH CAPS IN FITTING COLOURS THERMO PREMIUM AND THERMO PRIME, 2D HINGE WITH CAPS IN FITTING COLOURS OPTIMA
- CLASS 5 LOCK INSERTS, ONE KEY SYSTEM FOR THERMO PREMIUM AND OPTIMA DOORS

## EXTRA CHARGES

CUSTOM HEIGHT (THERMO PRIME)	2150 - 2200 mm	✓
AVAILABLE COLOURS: FRP, FDE, FDW, FKG, FKF	2250 - 2300 mm	✓
	2350 - 2400 mm	✓
ALUTHERM PREMIUM DOOR FRAME (THERMO PREMIUM DOOR) / ALUTHERM (OPTIMA 60)	✓	HIDDEN DOOR CLOSER (THERMO PRIME, THERMO PREMIUM) ✓
OPTIMA 50 PERFOTHERM DOOR FRAME	✓	ELECTRIC STRIKE WITH DAY / NIGHT FEATURE ✓
TWO-COLOUR DOOR	✓	AMSTERDAM / MONTREAL HANDHOLD 1500 mm ✓
RC3 PACKAGE	✓	AMSTERDAM / MONTREAL HANDHOLD 1000 mm ✓
CLASS 6 LOCK INSERTS, ONE KEY SYSTEM	✓	AMSTERDAM / MONTREAL HANDHOLD 1500 mm WITH PUSHBUTTON, WITH DOOR LEAF ADJUSTMENT ✓
UPPER ESCUTCHEON PROTECTION (THERMO PREMIUM, OPTIMA)	✓	AMSTERDAM / MONTREAL HANDHOLD 1000 mm WITH PUSHBUTTON, WITH DOOR LEAF ADJUSTMENT ✓
KNOB-HANDLE	✓	TEDEE SET ✓
REED SWITCH	✓	DOOR SHORTENING (10, 20, 30, 40, 60, 80, 100 mm) ✓
SIZE 100E	✓	

\* FIXED ALUMINUM ILLUMINATORS - PAGES 88-89, FULL EQUIPMENT LIST - PAGES 94-99

## DOOR COLOURS

### ALPINE WALNUT



FRR

### MAHOGANY



FMA

### BRAZILIAN WALNUT



FRB

### LIGHT WALNUT



FRP

### GOLD OAK



FDE

### WINCHESTER



FDW

### TURNER OAK



FDT

### LIGHT WENGE



FEJ

### WHITE



FSB

### STEEL GRAY



FKZ

### ANTHRACITE



FKG

### DARK ANTHRACITE



FKF

### BLACK



FKC



WOO FLAT



INTERNAL SIDE

### THERMO PRIME 75 DOOR CONFIGURATION



WOO FLAT



INTERNAL SIDE

#### FITTINGS

HANDLE-HANDLE



**THERMO PRIME**



**THERMO PREMIUM**



**OPTIMA**

HANDLE-KNOB



**THERMO PREMIUM**

HANDHOLD

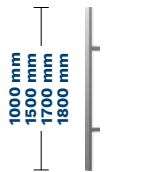

□ **AMSTERDAM**

○ **MONTREAL**

FITTING COLOURS

**PLATINUM ANODE**



**SILVER ANODE**



**BLACK ANODE**



### DOOR COLOURS

ALPINE WALNUT



FRR

MAHOGANY



FMA

BRAZILIAN WALNUT



FRB

LIGHT WALNUT



FRP

GOLD OAK



FDE

WINCHESTER



FDW

TURNER OAK



FDT

LIGHT WENGE



FEJ

WHITE



FSB

STEEL GRAY



FKZ

ANTHRACITE



FKG

DARK ANTHRACITE

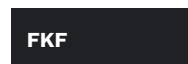

FKF

BLACK



FKC



**SNU MILANO 4**



**SNUA MILANO 4A**

SIZE (MILANO 4, MILANO 4A)	80N	80	90N	90E	100E
SIZE (MILANO 4B)	-	-	-	90E	-

MODEL	OPTIMA 50	OPTIMA 60
<b>SNU MILANO 4</b>	-	✓
<b>SNUA MILANO 4A</b>	-	✓
<b>SNUB MILANO 4B</b>	-	✓

## RC2 STANDARD EQUIPMENT

- GLAZED DOOR LEAF, COMPLIANT WITH THE "CLEAN AIR" PROGRAM TERMS
- 3 DOOR LEAF UPSTANDS
- OPTIMA 60 PERFOTHERM DOOR FRAME
- 2D HINGE WITH CAPS IN FITTING COLOURS
- DOUBLE-SIDED PATTERN
- ALUMINUM SILL
- FITTINGS SET WITH INSERT PROTECTION
- BERGEN AND BLOK SPLIT ESCUTCHEONS
- CLASS 5 LOCK INSERTS, ONE KEY SYSTEM

## EXTRA CHARGES

DOOR FRAME ALUTHERM OPTIMA	✓	ELECTRIC STRIKE WITH DAY / NIGHT FEATURE	✓
TWO-COLOUR DOOR	✓	AMSTERDAM / MONTREAL HANDHOLD 1500 mm, RECOMMENDED ELECTRIC STRIKE	✓
CLASS 6 LOCK INSERTS, ONE KEY SYSTEM	✓	AMSTERDAM / MONTREAL HANDHOLD 1000 mm, RECOMMENDED ELECTRIC STRIKE	✓
UPPER ESCUTCHEON PROTECTION	✓	AMSTERDAM / MONTREAL HANDHOLD 1500 mm WITH PUSHBUTTON, WITH DOOR LEAF ADJUSTMENT, ELECTRIC STRIKE REQUIRED	✓
KNOB-HANDLE	✓	AMSTERDAM / MONTREAL HANDHOLD 1000 mm WITH PUSHBUTTON, WITH DOOR LEAF ADJUSTMENT, ELECTRIC STRIKE REQUIRED	✓
REED SWITCH	✓	TEDEE SET	✓
SIZE 100E	✓	DOOR SHORTENING (10, 20, 30, 40, 60, 80, 100 mm)	✓

\* FIXED ALUMINUM ILLUMINATORS - PAGES 88-89, FULL EQUIPMENT LIST - PAGES 94-99

## GLASS



**MATTE**



**MATTE, SEE-THROUGH STRIPS**



**GRAPHITE**



**MIRA STAR (MIRROR GLASS)**

## DOOR COLOURS

### ALPINE WALNUT



**FRR**

### MAHOGANY



**FMA**

### BRAZILIAN WALNUT



**FRB**

### LIGHT WALNUT

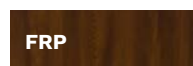

**FRP**

### GOLD OAK



**FDE**

### WINCHESTER



**FDW**

### TURNER OAK



**FDT**

### LIGHT WENGE



**FEJ**

### WHITE



**FSB**

### STEEL GRAY



**FKZ**

### ANTHRACITE



**FKG**

### DARK ANTHRACITE



**FKF**

### BLACK



**FKC**



**SNUB MILANO 4B**

### FITTINGS

#### HANDLE-HANDLE



#### HANDLE-KNOB

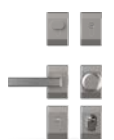

#### HANDHOLD



- AMSTERDAM**
- MONTREAL**

### FITTING COLOURS

#### PLATINUM ANODE



#### SILVER ANODE



#### BLACK ANODE



### DOOR COLOURS

#### ALPINE WALNUT



#### MAHOGANY



#### BRAZILIAN WALNUT



#### LIGHT WALNUT



#### GOLD OAK



#### WINCHESTER



#### TURNER OAK



#### LIGHT WENGE



#### WHITE



#### STEEL GRAY



#### ANTHRACITE



#### DARK ANTHRACITE



#### BLACK





**NT1 TURYN 1**



**NT1B TURYN 1B**

SIZE	80N	80	90N	90E	100E
------	-----	----	-----	-----	------

MODEL	OPTIMA 50	OPTIMA 60
<b>NT1 TURYN 1</b>	-	✓
<b>NT1B TURYN 1B</b>	-	✓
<b>NT2 TURYN 2</b>	-	✓
<b>NT2B TURYN 2B</b>	-	✓

### RC2 STANDARD EQUIPMENT

• GLAZED DOOR LEAF, COMPLIANT WITH THE "CLEAN AIR" PROGRAM TERMS	• ALUMINUM SILL
• 3 DOOR LEAF UPSTANDS	• FITTINGS SET WITH INSERT PROTECTION
• OPTIMA 60 PERFOTHERM DOOR FRAME	• BERGEN AND BLOK SPLIT ESCUTCHEONS
• 2D HINGE WITH CAPS IN FITTING COLOURS	• CLASS 5 LOCK INSERTS, ONE KEY SYSTEM
• DOUBLE-SIDED PATTERN	

### EXTRA CHARGES

DOOR FRAME ALUTHERM OPTIMA	✓	ELECTRIC STRIKE WITH DAY / NIGHT FEATURE	✓
TWO-COLOUR DOOR	✓	AMSTERDAM / MONTREAL HANDHOLD 1500 mm, RECOMMENDED ELECTRIC STRIKE	✓
CLASS 6 LOCK INSERTS, ONE KEY SYSTEM	✓	AMSTERDAM / MONTREAL HANDHOLD 1000 mm, RECOMMENDED ELECTRIC STRIKE	✓
UPPER ESCUTCHEON PROTECTION	✓	AMSTERDAM / MONTREAL HANDHOLD 1500 mm WITH PUSHBUTTON, WITH DOOR LEAF ADJUSTMENT, ELECTRIC STRIKE REQUIRED	✓
KNOB-HANDLE	✓	AMSTERDAM / MONTREAL HANDHOLD 1000 mm WITH PUSHBUTTON, WITH DOOR LEAF ADJUSTMENT, ELECTRIC STRIKE REQUIRED	✓
REED SWITCH	✓	TEDEE SET	✓
SIZE 100E	✓		✓

\* FIXED ALUMINUM ILLUMINATORS – PAGES 88–89, FULL EQUIPMENT LIST – PAGES 94–99

### GLASS



**MATTE**



**MATTE, SEE-THROUGH STRIPS**



**GRAPHITE**



### DOOR COLOURS

#### ALPINE WALNUT



**FRR**

#### MAHOGANY



**FMA**

#### BRAZILIAN WALNUT



**FRB**

#### LIGHT WALNUT



**FRP**

#### GOLD OAK



**FDE**

#### WINCHESTER



**FDW**

#### TURNER OAK



**FDT**

#### LIGHT WENGE



**FEJ**

#### WHITE



**FSB**

#### STEEL GRAY



**FKZ**

#### ANTHRACITE



**FKG**

#### DARK ANTHRACITE



**FKF**

#### BLACK



**FKC**





NT2 TURYN 2



NT2B TURYN 2B

### FITTINGS

#### HANDLE-HANDLE



#### HANDLE-KNOB



#### HANDHOLD



- AMSTERDAM
- MONTREAL

### FITTING COLOURS

#### PLATINUM ANODE



#### SILVER ANODE



#### BLACK ANODE



### DOOR COLOURS

#### ALPINE WALNUT



#### MAHOGANY



#### BRAZILIAN WALNUT



#### LIGHT WALNUT



#### GOLD OAK



#### WINCHESTER



#### TURNER OAK



#### LIGHT WENGE



#### WHITE



#### STEEL GRAY



#### ANTHRACITE



#### DARK ANTHRACITE



#### BLACK



# TEMPO

## BERGAMO / NICEA / BERLIN



SOJ BERGAMO 2



SJ9 NICEA 9

SIZE	80N	80	90N	90E	100E
------	-----	----	-----	-----	------

MODEL	OPTIMA 50	OPTIMA 60
SOJ BERGAMO 2	-	✓
SJ9 NICEA 9	-	✓
SBE BERLIN	-	✓

### RC2 STANDARD EQUIPMENT

- GLAZED DOOR LEAF, COMPLIANT WITH THE "CLEAN AIR" PROGRAM TERMS
- 3 DOOR LEAF UPSTANDS
- OPTIMA 60 PERFOTHERM DOOR FRAME
- 2D HINGE WITH CAPS IN FITTING COLOURS
- DOUBLE-SIDED PATTERN
- ALUMINUM SILL
- FITTINGS SET WITH INSERT PROTECTION
- BERGEN AND BLOK SPLIT ESCUTCHEONS
- CLASS 5 LOCK INSERTS, ONE KEY SYSTEM

### EXTRA CHARGES

DOOR FRAME ALUTHERM OPTIMA	✓	ELECTRIC STRIKE WITH DAY / NIGHT FEATURE	✓
TWO-COLOUR DOOR	✓	AMSTERDAM / MONTREAL HANDHOLD 1500 mm, RECOMMENDED ELECTRIC STRIKE	✓
CLASS 6 LOCK INSERTS, ONE KEY SYSTEM	✓	AMSTERDAM / MONTREAL HANDHOLD 1000 mm, RECOMMENDED ELECTRIC STRIKE	✓
UPPER ESCUTCHEON PROTECTION	✓	AMSTERDAM / MONTREAL HANDHOLD 1500 mm WITH PUSHBUTTON, WITH DOOR LEAF ADJUSTMENT, ELECTRIC STRIKE REQUIRED	✓
KNOB-HANDLE	✓	AMSTERDAM / MONTREAL HANDHOLD 1000 mm WITH PUSHBUTTON, WITH DOOR LEAF ADJUSTMENT, ELECTRIC STRIKE REQUIRED	✓
REED SWITCH	✓	TEDEE SET	✓
SIZE 100E	✓	DOOR SHORTENING SJ9 (10, 20, 30, 40 mm) SBE (10, 20, 30, 40, 60, 80, 100 mm)	✓

\* FIXED ALUMINUM ILLUMINATORS – PAGES 88–89, FULL EQUIPMENT LIST – PAGES 94–99

### GLASS (BERGAMO / NICEA)



MATTE

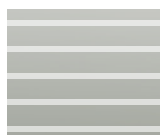

MATTE, SEE-THROUGH STRIPS



MIRA STAR (MIRROR GLASS)

### DOOR COLOURS

ALPINE WALNUT



FRR

MAHOGANY



FMA

BRAZILIAN WALNUT



FRB

LIGHT WALNUT



FRP

GOLD OAK



FDE

WINCHESTER



FDW

TURNER OAK



FDT

LIGHT WENGE



FEJ

WHITE

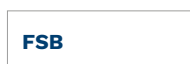

FSB

STEEL GRAY



FKZ

ANTHRACITE



FKG

DARK ANTHRACITE



FKF

BLACK



FKC



**SBE BERLIN**

### GLASS (BERLIN)



**MATTE**



**BROWN REFLECTIVE**

### DOOR COLOURS

**ALPINE WALNUT**



**FRR**

**MAHOGANY**



**FMA**

**BRAZILIAN WALNUT**



**FRB**

**LIGHT WALNUT**



**FRP**

**GOLD OAK**



**FDE**

**WINCHESTER**



**FDW**

**TURNER OAK**



**FDT**

**LIGHT WENGE**



**FEJ**

**WHITE**



**FSB**

**STEEL GRAY**



**FKZ**

**ANTHRACITE**



**FKG**

**DARK ANTHRACITE**



**FKF**

**BLACK**



**FKC**

### FITTINGS

HANDLE-HANDLE



HANDLE-KNOB



HANDHOLD



- AMSTERDAM**
- MONTREAL**

### FITTING COLOURS

**PLATINUM ANODE**



**SILVER ANODE**



**BLACK ANODE**





**ST4 UPPSALA 1**  
(pressed without inserts)



**ST4A UPPSALA 1A** (inox inserts)

SIZE	80N	80	90N	90E	100E
------	-----	----	-----	-----	------

MODEL	OPTIMA 50	OPTIMA 60
<b>ST4 UPPSALA 1</b>	✓	✓
<b>ST4A UPPSALA 1A</b>	✓	✓
<b>ST5 UPPSALA 2</b>	✓	✓
<b>ST5A UPPSALA 2A</b>	✓	✓

### RC2 STANDARD EQUIPMENT

- GLAZED DOOR LEAF, COMPLIANT WITH THE "CLEAN AIR" PROGRAM TERMS
- ALUMINUM SILL
- 3 DOOR LEAF UPSTANDS
- FITTINGS SET WITH INSERT PROTECTION
- OPTIMA 50 STEEL DORFRAME, OPTIMA 60 PERFOTHERM DOOR FRAME
- BERGEN AND BLOK SPLIT ESCUTCHEONS
- 2D HINGE WITH CAPS IN FITTING COLOURS
- CLASS 5 LOCK INSERTS, ONE KEY SYSTEM
- DOUBLE-SIDED PATTERN

### EXTRA CHARGES

ALUTHERM OPTIMA DOOR FRAME (OPTIMA 60)	✓	SIZE 100E	✓
PERFOTHERM STEEL DOOR FRAME (OPTIMA 50)	✓	AMSTERDAM / MONTREAL HANDHOLD 1500 mm, RECOMMENDED ELECTRIC STRIKE	✓
TWO-COLOUR DOOR	✓	AMSTERDAM / MONTREAL HANDHOLD 1000 mm, RECOMMENDED ELECTRIC STRIKE	✓
RC3 PACKAGE	✓	AMSTERDAM / MONTREAL HANDHOLD 1500 mm WITH PUSHBUTTON, WITH DOOR LEAF ADJUSTMENT, ELECTRIC STRIKE REQUIRED	✓
CLASS 6 LOCK INSERTS, ONE KEY SYSTEM	✓	AMSTERDAM / MONTREAL HANDHOLD 1000 mm WITH PUSHBUTTON, WITH DOOR LEAF ADJUSTMENT, ELECTRIC STRIKE REQUIRED	✓
UPPER ESCUTCHEON PROTECTION	✓	ELECTRIC STRIKE WITH DAY / NIGHT FEATURE	✓
KNOB-HANDLE	✓	TEDEE SET	✓
REED SWITCH	✓		

\* FIXED ALUMINUM ILLUMINATORS – PAGES 88–89, FULL EQUIPMENT LIST – PAGES 94–99

### DOOR COLOURS

ALPINE WALNUT



FRR

MAHOGANY



FMA

BRAZILIAN WALNUT



FRB

LIGHT WALNUT



FRP

GOLD OAK



FDE

WINCHESTER



FDW

TURNER OAK



FDT

LIGHT WENGE



FEJ

WHITE



FSB

STEEL GRAY



FKZ

ANTHRACITE



FKG

DARK ANTHRACITE



FKF

BLACK



FKC



**ST5 UPPSALA 2**  
(pressed without inserts)



**ST5A UPPSALA 2A** (inox inserts)

### FITTINGS

#### HANDLE-HANDLE



#### HANDLE-KNOB



#### HANDHOLD



- AMSTERDAM
- MONTREAL

### FITTING COLOURS

#### PLATINUM ANODE



#### SILVER ANODE



#### BLACK ANODE



### DOOR COLOURS

#### ALPINE WALNUT



#### MAHOGANY



#### BRAZILIAN WALNUT



#### LIGHT WALNUT



#### GOLD OAK



#### WINCHESTER



#### TURNER OAK



#### LIGHT WENGE



#### WHITE



#### STEEL GRAY



#### ANTHRACITE



#### DARK ANTHRACITE

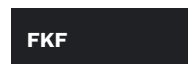

#### BLACK





**TML TOKIO 1**  
(pressed without inserts)



**TMLA TOKIO 1A** (inox inserts)

SIZE	80N	80	90N	90E	100E
------	-----	----	-----	-----	------

MODEL	OPTIMA 50	OPTIMA 60
<b>TML TOKIO 1</b>	✓	✓
<b>TMLA TOKIO 1A</b>	✓	✓
<b>TMm TOKIO 2</b>	✓	✓
<b>TMmA TOKIO 2A</b>	✓	✓

### RC2 STANDARD EQUIPMENT

- GLAZED DOOR LEAF, COMPLIANT WITH THE "CLEAN AIR" PROGRAM TERMS
- 3 DOOR LEAF UPSTANDS
- OPTIMA 50 STEEL DORFRAME, OPTIMA 60 PERFOTHERM DOOR FRAME
- 2D HINGE WITH CAPS IN FITTING COLOURS
- DOUBLE-SIDED PATTERN
- ALUMINUM SILL
- FITTINGS SET WITH INSERT PROTECTION
- BERGEN AND BLOK SPLIT ESCUTCHEONS
- CLASS 5 LOCK INSERTS, ONE KEY SYSTEM

### EXTRA CHARGES

ALUTHERM OPTIMA DOOR FRAME (OPTIMA 60)	✓	SIZE 100E	✓
PERFOTHERM STEEL DOOR FRAME (OPTIMA 50)	✓	AMSTERDAM / MONTREAL HANDHOLD 1500 mm, RECOMMENDED ELECTRIC STRIKE	✓
TWO-COLOUR DOOR	✓	AMSTERDAM / MONTREAL HANDHOLD 1000 mm, RECOMMENDED ELECTRIC STRIKE	✓
RC3 PACKAGE	✓	AMSTERDAM / MONTREAL HANDHOLD 1500 mm WITH PUSHBUTTON, WITH DOOR LEAF ADJUSTMENT, ELECTRIC STRIKE REQUIRED	✓
CLASS 6 LOCK INSERTS, ONE KEY SYSTEM	✓	AMSTERDAM / MONTREAL HANDHOLD 1000 mm WITH PUSHBUTTON, WITH DOOR LEAF ADJUSTMENT, ELECTRIC STRIKE REQUIRED	✓
UPPER ESCUTCHEON PROTECTION	✓	ELECTRIC STRIKE WITH DAY / NIGHT FEATURE	✓
KNOB-HANDLE	✓	TEDEE SET	✓
REED SWITCH	✓		

\* FIXED ALUMINUM ILLUMINATORS – PAGES 88–89, FULL EQUIPMENT LIST – PAGES 94–99

\* DOŚWIETLA ALUMINIOWE STAŁE STRONA (88 - 89), PEŁNA LISTA WYPOSAŻENIA STRONY (94 - 99)

### DOOR COLOURS

#### ALPINE WALNUT



FRR

#### MAHOGANY



FMA

#### BRAZILIAN WALNUT



FRB

#### LIGHT WALNUT



FRP

#### GOLD OAK



FDE

#### WINCHESTER



FDW

#### TURNER OAK



FDT

#### LIGHT WENGE



FEJ

#### WHITE

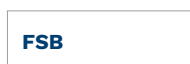

FSB

#### STEEL GRAY



FKZ

#### ANTHRACITE



FKG

#### DARK ANTHRACITE



FKF

#### BLACK



FKC



**TMM TOKIO 2**  
(pressed without inserts)



**TMM TOKIO 2A** (inox inserts)

### FITTINGS

#### HANDLE-HANDLE



#### HANDLE-KNOB



#### HANDHOLD



- AMSTERDAM
- MONTREAL

### FITTING COLOURS

#### PLATINUM ANODE



#### SILVER ANODE



#### BLACK ANODE



### DOOR COLOURS

#### ALPINE WALNUT



FRR

#### MAHOGANY



FMA

#### BRAZILIAN WALNUT



FRB

#### LIGHT WALNUT



FRP

#### GOLD OAK



FDE

#### WINCHESTER



FDW

#### TURNER OAK



FDT

#### LIGHT WENGE



FEJ

#### WHITE



FSB

#### STEEL GRAY



FKZ

#### ANTHRACITE



FKG

#### DARK ANTHRACITE

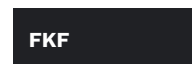

FKF

#### BLACK



FKC

# TEMPO RYGA / LUND / ASPEN



**ST8 RYGA**



**ST9 LUND**

SIZE	80N	80	90N	90E	100E
------	-----	----	-----	-----	------

MODEL	OPTIMA 50	OPTIMA 60
<b>ST8 RYGA</b>	✓	✓
<b>ST9 LUND</b>	✓	✓
<b>WBA ASPEN 1</b>	✓	✓
<b>TN7 ASPEN 2</b>	✓	✓
<b>TN7B ASPEN 2B</b>	✓	✓

## RC2 STANDARD EQUIPMENT

- DOOR LEAF COMPLIANT WITH THE "CLEAN AIR" PROGRAM TERMS
- 3 DOOR LEAF UPSTANDS
- OPTIMA 50 STEEL DOOR FRAME, OPTIMA 60 PERFOOTHERM DOOR FRAME
- 2D HINGE WITH CAPS IN FITTING COLOURS
- DOUBLE-SIDED PATTERN
- ALUMINUM SILL
- FITTINGS SET WITH INSERT PROTECTION
- BERGEN AND BLOK SPLIT ESCUTCHEONS
- CLASS 5 LOCK INSERTS, ONE KEY SYSTEM

## EXTRA CHARGES

ALUTHERM OPTIMA DOOR FRAME (OPTIMA 60)	✓	ELECTRIC STRIKE WITH DAY / NIGHT FEATURE	✓
PERFOOTHERM STEEL DOOR FRAME (OPTIMA 50)	✓	AMSTERDAM / MONTREAL HANDHOLD 1500 mm, RECOMMENDED ELECTRIC STRIKE	✓
TWO-COLOUR DOOR	✓	AMSTERDAM / MONTREAL HANDHOLD 1000 mm, RECOMMENDED ELECTRIC STRIKE	✓
RC3 PACKAGE	✓	AMSTERDAM / MONTREAL HANDHOLD 1500 mm WITH PUSHBUTTON, WITH DOOR LEAF ADJUSTMENT, ELECTRIC STRIKE REQUIRED	✓
CLASS 6 LOCK INSERTS, ONE KEY SYSTEM	✓	AMSTERDAM / MONTREAL HANDHOLD 1000 mm WITH PUSHBUTTON, WITH DOOR LEAF ADJUSTMENT, ELECTRIC STRIKE REQUIRED	✓
UPPER ESCUTCHEON PROTECTION	✓	TEDEE SET	✓
KNOB-HANDLE	✓	DOOR SHORTENING WBA, TN7, TN7B (10, 20, 30, 40, 60, 80, 100 mm)	✓
REED SWITCH	✓		
SIZE 100E	✓		

\* FIXED ALUMINUM ILLUMINATORS – PAGES 88–89, FULL EQUIPMENT LIST – PAGES 94–99

## DOOR COLOURS

### ALPINE WALNUT



FRR

### MAHOGANY



FMA

### BRAZILIAN WALNUT



FRB

### LIGHT WALNUT



FRP

### GOLD OAK



FDE

### WINCHESTER



FDW

### TURNER OAK



FDT

### LIGHT WENGE



FEJ

### WHITE

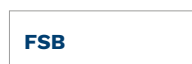

FSB

### STEEL GRAY



FKZ

### ANTHRACITE



FKG

### DARK ANTHRACITE



FKF

### BLACK



FKC





WBA ASPEN 1



TN7 ASPEN 2



TN7B ASPEN 2B

### FITTINGS

#### HANDLE-HANDLE



#### HANDLE-KNOB

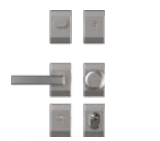

#### HANDHOLD



- AMSTERDAM
- MONTREAL

### FITTING COLOURS

#### PLATINUM ANODE



#### SILVER ANODE



#### BLACK ANODE



### DOOR COLOURS

#### ALPINE WALNUT



#### MAHOGANY



#### BRAZILIAN WALNUT



#### LIGHT WALNUT



#### GOLD OAK



#### WINCHESTER



#### TURNER OAK



#### LIGHT WENGE



#### WHITE



#### STEEL GRAY



#### ANTHRACITE



#### DARK ANTHRACITE

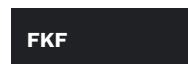

#### BLACK





**SR3 TROMSO**



**SR4 TROMSO 1**

SIZE	80N	80	90N	90E	100E
------	-----	----	-----	-----	------

MODEL	OPTIMA 50	OPTIMA 60
<b>SR3 TROMSO</b>	✓	✓
<b>SR4 TROMSO 1</b>	✓	✓
<b>SR5 TROMSO 2</b>	✓	✓

### RC2 STANDARD EQUIPMENT

- DOOR LEAF COMPLIANT WITH THE "CLEAN AIR" PROGRAM TERMS
- 3 DOOR LEAF UPSTANDS
- OPTIMA 50 STEEL DOOR FRAME, OPTIMA 60 PERFOOTHERM DOOR FRAME
- 2D HINGE WITH CAPS IN FITTING COLOURS
- DOUBLE-SIDED PATTERN
- ALUMINUM SILL
- FITTINGS SET WITH INSERT PROTECTION
- BERGEN AND BLOK SPLIT ESCUTCHEONS
- CLASS 5 LOCK INSERTS, ONE KEY SYSTEM

### EXTRA CHARGES

ALUTHERM OPTIMA DOOR FRAME (OPTIMA 60)	✓	ELECTRIC STRIKE WITH DAY / NIGHT FEATURE	✓
PERFOOTHERM STEEL DOOR FRAME (OPTIMA 50)	✓	AMSTERDAM / MONTREAL HANDHOLD 1500 mm, RECOMMENDED ELECTRIC STRIKE	✓
TWO-COLOUR DOOR	✓	AMSTERDAM / MONTREAL HANDHOLD 1000 mm, RECOMMENDED ELECTRIC STRIKE	✓
RC3 PACKAGE	✓	AMSTERDAM / MONTREAL HANDHOLD 1500 mm WITH PUSHBUTTON, WITH DOOR LEAF ADJUSTMENT, ELECTRIC STRIKE REQUIRED	✓
CLASS 6 LOCK INSERTS, ONE KEY SYSTEM	✓	AMSTERDAM / MONTREAL HANDHOLD 1000 mm WITH PUSHBUTTON, WITH DOOR LEAF ADJUSTMENT, ELECTRIC STRIKE REQUIRED	✓
UPPER ESCUTCHEON PROTECTION	✓	TEDEE SET	✓
KNOB-HANDLE	✓	DOOR SHORTENING SR4 (10, 20, 30, 40 mm)	✓
REED SWITCH	✓		
SIZE 100E	✓		

\* FIXED ALUMINUM ILLUMINATORS – PAGES 88–89, FULL EQUIPMENT LIST – PAGES 94–99

### DOOR COLOURS

#### ALPINE WALNUT



FRR

#### MAHOGANY



FMA

#### BRAZILIAN WALNUT



FRB

#### LIGHT WALNUT



FRP

#### GOLD OAK



FDE

#### WINCHESTER



FDW

#### TURNER OAK



FDT

#### LIGHT WENGE



FEJ

#### WHITE

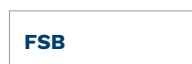

FSB

#### STEEL GRAY



FKZ

#### ANTHRACITE



FKG

#### DARK ANTHRACITE



FKF

#### BLACK



FKC



SR5 TROMSO 2

### FITTINGS

#### HANDLE-HANDLE



#### HANDLE-KNOB



#### HANDHOLD



- AMSTERDAM
- MONTREAL

### FITTING COLOURS

#### PLATINUM ANODE



#### SILVER ANODE



#### BLACK ANODE



### DOOR COLOURS

#### ALPINE WALNUT



#### MAHOGANY



#### BRAZILIAN WALNUT



#### LIGHT WALNUT



#### GOLD OAK



#### WINCHESTER



#### TURNER OAK



#### LIGHT WENGE



#### WHITE



#### STEEL GRAY



#### ANTHRACITE



#### DARK ANTHRACITE



#### BLACK



# CLASSIC MODENA / RAVENA

# GERDA®



**W76 MODENA**



**W77 MODENA 2**

SIZE	80	90N	90E
------	----	-----	-----

MODEL	OPTIMA 50	OPTIMA 60
<b>W76 MODENA</b>	-	✓
<b>W77 MODENA 2</b>	-	✓
<b>W78 MODENA 3</b>	-	✓
<b>WDR RAVENA</b>	✓	✓

## RC2 STANDARD EQUIPMENT

- |  |  |
|--|--|
| • GLAZED DOOR LEAF, COMPLIANT WITH THE "CLEAN AIR" PROGRAM TERMS | • ALUMINUM SILL                        |
| • 3 DOOR LEAF UPSTANDS   | • FITTINGS SET WITH INSERT PROTECTION  |
| • OPTIMA 50 STEEL DOOR FRAME, OPTIMA 60 PERFOTHERM DOOR FRAME    | • BERGEN AND BLOK SPLIT ESCUTCHEONS    |
| • 2D HINGE WITH CAPS IN FITTING COLOURS                          | • CLASS 5 LOCK INSERTS, ONE KEY SYSTEM |
| • DOUBLE-SIDED PATTERN   | • DEEP STAMPING                        |

## EXTRA CHARGES

ALUTHERM OPTIMA DOOR FRAME (OPTIMA 60)	✓	ELECTRIC STRIKE WITH DAY / NIGHT FEATURE	✓
PERFOTHERM STEEL DOOR FRAME (OPTIMA 50)	✓	TEDEE SET	✓
TWO-COLOUR DOOR	✓	DOOR SHORTENING (10, 20, 30, 40, 60, 80, 100 mm)	✓
RC3 PACKAGE (OPTIMA 60 DESIGN WDR)	✓		
CLASS 6 LOCK INSERTS, ONE KEY SYSTEM	✓		
UPPER ESCUTCHEON PROTECTION	✓		
KNOB-HANDLE	✓		
REED SWITCH	✓		

\* FIXED ALUMINUM ILLUMINATORS – PAGES 88-89, FULL EQUIPMENT LIST – PAGES 94-99

## GLASS



**MATTE**



**BROWN REFLECTIVE**



**MIRA STAR (MIRROR GLASS)**

## DOOR COLOURS

**ALPINE WALNUT**



**FRR**

**MAHOGANY**



**FMA**

**BRAZILIAN WALNUT**



**FRB**

**LIGHT WALNUT**



**FRP**

**GOLD OAK**



**FDE**

**WINCHESTER**



**FDW**

**WHITE**



**FSB**

**STEEL GRAY**



**FKZ**

**ANTHRACITE**



**FKG**

**DARK ANTHRACITE**



**FKF**



**W78 MODENA 3**



**WDR RAVENA**

## FITTINGS

### HANDLE-HANDLE



### HANDLE-KNOB

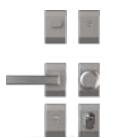

## FITTING COLOURS

### PLATINUM ANODE



### SILVER ANODE



### BLACK ANODE



## DOOR COLOURS

### ALPINE WALNUT



**FRR**

### MAHOGANY



**FMA**

### BRAZILIAN WALNUT



**FRB**

### LIGHT WALNUT



**FRP**

### GOLD OAK



**FDE**

### WINCHESTER



**FDW**

### WHITE



**FSB**

### STEEL GRAY



**FKZ**

### ANTHRACITE



**FKG**

### DARK ANTHRACITE



**FKF**

# CLASSIC NICEA / OLYMPIA



**WJ1 NICEA 5**

SIZE	80	90N	90E
------	----	-----	-----

MODEL	OPTIMA 50	OPTIMA 60
<b>WJ1 NICEA 5</b>	-	✓
<b>W23 OLYMPIA</b>	-	✓

## RC2 STANDARD EQUIPMENT

- GLAZED DOOR LEAF, COMPLIANT WITH THE "CLEAN AIR" PROGRAM TERMS
- ALUMINUM SILL
- 3 DOOR LEAF UPSTANDS
- FITTINGS SET WITH INSERT PROTECTION
- OPTIMA 60 PERFOTHERM DOOR FRAME
- BERGEN AND BLOK SPLIT ESCUTCHEONS
- 2D HINGE WITH CAPS IN FITTING COLOURS
- CLASS 5 LOCK INSERTS, ONE KEY SYSTEM
- DOUBLE-SIDED PATTERN
- DEEP STAMPING

## EXTRA CHARGES

ALUTHERM OPTIMA DOOR FRAME (OPTIMA 60)	✓	ELECTRIC STRIKE WITH DAY / NIGHT FEATURE	✓
PERFOTHERM STEEL DOOR FRAME (OPTIMA 50)	✓	TEDEE SET	✓
TWO-COLOUR DOOR	✓	DOOR SHORTENING (10, 20, 30, 40, 60, 80, 100 mm)	✓
SIZE 100E (DESIGN W23)	✓		
CLASS 6 LOCK INSERTS, ONE KEY SYSTEM	✓		
UPPER ESCUTCHEON PROTECTION	✓		
KNOB-HANDLE	✓		
REED SWITCH	✓		

\* FIXED ALUMINUM ILLUMINATORS – PAGES 88–89, FULL EQUIPMENT LIST – PAGES 94–99

## GLASS



**MATTE**



**GRAPHITE**



**MIRA STAR (MIRROR GLASS)**

## DOOR COLOURS

### ALPINE WALNUT



**FRR**

### MAHOGANY



**FMA**

### BRAZILIAN WALNUT



**FRB**

### LIGHT WALNUT



**FRP**

### GOLD OAK



**FDE**

### WINCHESTER



**FDW**

### WHITE



**FSB**

### STEEL GRAY



**FKZ**

### ANTHRACITE



**FKG**

### DARK ANTHRACITE



**FKF**



**W23 OLYMPIA**

## FITTINGS

### HANDLE-HANDLE



### HANDLE-KNOB



## FITTING COLOURS

### PLATINUM ANODE



### SILVER ANODE



### BLACK ANODE



## DOOR COLOURS

### ALPINE WALNUT



### MAHOGANY



### BRAZILIAN WALNUT



### LIGHT WALNUT



### GOLD OAK



### WINCHESTER



### WHITE



### STEEL GRAY



### ANTHRACITE



### DARK ANTHRACITE





**W91 WERONA**



**W94 WERONA 1**

SIZE	80	90N	90E
------	----	-----	-----

MODEL	OPTIMA 50	OPTIMA 60
<b>W91 WERONA</b>	✓	✓
<b>W94 WERONA 1</b>	-	✓
<b>W93 WERONA 3</b>	-	✓
<b>W6A WERONA 4</b>	-	✓
<b>WQA WERONA 5</b>	-	✓

## RC2 STANDARD EQUIPMENT

- GLAZED DOOR LEAF, COMPLIANT WITH THE "CLEAN AIR" PROGRAM TERMS
- 3 DOOR LEAF UPSTANDS
- OPTIMA 50 STEEL DOOR FRAME, OPTIMA 60 PERFOOTHERM DOOR FRAME
- 2D HINGE WITH CAPS IN FITTING COLOURS
- DOUBLE-SIDED PATTERN
- ALUMINUM SILL
- FITTINGS SET WITH INSERT PROTECTION
- BERGEN AND BLOK SPLIT ESCUTCHEONS
- CLASS 5 LOCK INSERTS, ONE KEY SYSTEM
- DEEP STAMPING

## EXTRA CHARGES

ALUTHERM OPTIMA DOOR FRAME (OPTIMA 60)	✓	ELECTRIC STRIKE WITH DAY / NIGHT FEATURE	✓
PERFOOTHERM STEEL DOOR FRAME (OPTIMA 50)	✓	TEDEE SET	✓
TWO-COLOUR DOOR	✓	DOOR SHORTENING (10, 20, 30, 40, 60, 80, 100 mm)	✓
RC3 PACKAGE (OPTIMA 60 DESIGN W91)	✓		
CLASS 6 LOCK INSERTS, ONE KEY SYSTEM	✓		
UPPER ESCUTCHEON PROTECTION	✓		
KNOB-HANDLE	✓		
REED SWITCH	✓		

\* FIXED ALUMINUM ILLUMINATORS – PAGES 88–89, FULL EQUIPMENT LIST – PAGES 94–99

## GLASS



**MATTE**



**BROWN REFLECTIVE**



**MIRA STAR (MIRROR GLASS)**

## DOOR COLOURS

### ALPINE WALNUT



**FRR**

### MAHOGANY



**FMA**

### BRAZILIAN WALNUT



**FRB**

### LIGHT WALNUT



**FRP**

### GOLD OAK



**FDE**

### WINCHESTER



**FDW**

### WHITE



**FSB**

### STEEL GRAY



**FKZ**

### ANTHRACITE



**FKG**

### DARK ANTHRACITE



**FKF**





**W93 WERONA 3**



**W6A WERONA 4**



**WQA WERONA 5**

## FITTINGS

### HANDLE-HANDLE



### HANDLE-KNOB

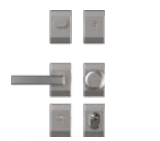

## FITTING COLOURS

### PLATINUM ANODE



### SILVER ANODE



### BLACK ANODE



## DOOR COLOURS

### ALPINE WALNUT



### MAHOGANY



### BRAZILIAN WALNUT



### LIGHT WALNUT



### GOLD OAK



### WINCHESTER



### WHITE



### STEEL GRAY



### ANTHRACITE



### DARK ANTHRACITE



# CLASSIC

## LIZBONA / WENECJA / LONDYN



**W24 LIZBONA**



**W9N WENECJA**

SIZE	80	90N	90E
------	----	-----	-----

MODEL	OPTIMA 50	OPTIMA 60
<b>W24 LIZBONA</b>	✓	✓
<b>W9N WENECJA</b>	✓	✓
<b>W13 LONDYN</b>	✓	✓
<b>W5L LONDYN 1</b>	-	✓

### RC2 STANDARD EQUIPMENT

- |  |  |
|--|--|
| • GLAZED DOOR LEAF, COMPLIANT WITH THE "CLEAN AIR" PROGRAM TERMS | • ALUMINUM SILL                        |
| • 3 DOOR LEAF UPSTANDS   | • FITTINGS SET WITH INSERT PROTECTION  |
| • OPTIMA 50 STEEL DOOR FRAME, OPTIMA 60 PERFOOTHERM DOOR FRAME   | • BERGEN AND BLOK SPLIT ESCUTCHEONS    |
| • 2D HINGE WITH CAPS IN FITTING COLOURS                          | • CLASS 5 LOCK INSERTS, ONE KEY SYSTEM |
| • DOUBLE-SIDED PATTERN   | • DEEP STAMPING                        |

### EXTRA CHARGES

ALUTHERM OPTIMA DOOR FRAME (OPTIMA 60)	✓	ELECTRIC STRIKE WITH DAY / NIGHT FEATURE	✓
PERFOOTHERM STEEL DOOR FRAME (OPTIMA 50)	✓	TEDEE SET	✓
TWO-COLOUR DOOR	✓	DOOR SHORTENING (10, 20, 30, 40, 60, 80, 100 mm)	✓
RC3 PACKAGE (OPTIMA 60 DESIGN W24, W9N, W13)	✓		
CLASS 6 LOCK INSERTS, ONE KEY SYSTEM	✓		
UPPER ESCUTCHEON PROTECTION	✓		
KNOB-HANDLE	✓		
REED SWITCH	✓		

\* FIXED ALUMINUM ILLUMINATORS – PAGES 88–89, FULL EQUIPMENT LIST – PAGES 94–99

### GLASS



**MATTE**



**BROWN REFLECTIVE**



**MIRA STAR (MIRROR GLASS)**

### DOOR COLOURS

#### ALPINE WALNUT



**FRR**

#### MAHOGANY



**FMA**

#### BRAZILIAN WALNUT



**FRB**

#### LIGHT WALNUT



**FRP**

#### GOLD OAK



**FDE**

#### WINCHESTER



**FDW**

#### WHITE



**FSB**

#### STEEL GRAY



**FKZ**

#### ANTHRACITE



**FKG**

#### DARK ANTHRACITE



**FKF**

# GERDA CLASSIC

## LIZBONA / WENECJA / LONDYN



W13 LONDYN



W5L LONDYN 1

### FITTINGS

#### HANDLE-HANDLE



#### HANDLE-KNOB

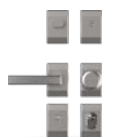

### FITTING COLOURS

#### PLATINUM ANODE



#### SILVER ANODE



#### BLACK ANODE



### DOOR COLOURS

#### ALPINE WALNUT



#### MAHOGANY



#### BRAZILIAN WALNUT



#### LIGHT WALNUT



#### GOLD OAK



#### WINCHESTER



#### WHITE



#### STEEL GRAY



#### ANTHRACITE



#### DARK ANTHRACITE



# CLASSIC BARCELONA / GENEWA



**W54 BARCELONA**



**W53 BARCELONA 1**

SIZE	80	90N	90E
------	----	-----	-----

MODEL	OPTIMA 50	OPTIMA 60
<b>W54 BARCELONA</b>	✓	✓
<b>W53 BARCELONA 1</b>	-	✓
<b>G76 GENEWA 1</b>	-	✓
<b>G75 GENEWA 2</b>	-	✓
<b>D75 GENEWA 3</b>	✓	✓

## RC2 STANDARD EQUIPMENT

- GLAZED DOOR LEAF, COMPLIANT WITH THE "CLEAN AIR" PROGRAM TERMS
- 3 DOOR LEAF UPSTANDS
- OPTIMA 50 STEEL DOOR FRAME, OPTIMA 60 PERFOOTHERM DOOR FRAME
- 2D HINGE WITH CAPS IN FITTING COLOURS
- DOUBLE-SIDED PATTERN
- ALUMINUM SILL
- FITTINGS SET WITH INSERT PROTECTION
- BERGEN AND BLOK SPLIT ESCUTCHEONS
- CLASS 5 LOCK INSERTS, ONE KEY SYSTEM
- DEEP STAMPING (BARCELONA)

## EXTRA CHARGES

ALUTHERM OPTIMA DOOR FRAME (OPTIMA 60)	✓	ELECTRIC STRIKE WITH DAY / NIGHT FEATURE	✓
PERFOOTHERM STEEL DOOR FRAME (OPTIMA 50)	✓	TEDEE SET	✓
TWO-COLOUR DOOR	✓	DOOR SHORTENING (10, 20, 30, 40, 60, 80, 100 mm)	✓
RC3 PACKAGE (OPTIMA 60 DESIGN W54, D75)	✓		
CLASS 6 LOCK INSERTS, ONE KEY SYSTEM	✓		
UPPER ESCUTCHEON PROTECTION	✓		
KNOB-HANDLE	✓		
REED SWITCH	✓		

\* FIXED ALUMINUM ILLUMINATORS – PAGES 88–89, FULL EQUIPMENT LIST – PAGES 94–99

## GLASS



**MATTE**



**BROWN REFLECTIVE**



**MIRA STAR (MIRROR GLASS)**

## DOOR COLOURS

### ALPINE WALNUT



**FRR**

### MAHOGANY



**FMA**

### BRAZILIAN WALNUT



**FRB**

### LIGHT WALNUT



**FRP**

### GOLD OAK



**FDE**

### WINCHESTER



**FDW**

### WHITE



**FSB**

### STEEL GRAY



**FKZ**

### ANTHRACITE



**FKG**

### DARK ANTHRACITE



**FKF**



**G76 GENEWA 1**



**G75 GENEWA 2**



**D75 GENEWA 3**

## FITTINGS

### HANDLE-HANDLE



### HANDLE-KNOB



## FITTING COLOURS

### PLATINUM ANODE



### SILVER ANODE



### BLACK ANODE



## DOOR COLOURS

### ALPINE WALNUT



### MAHOGANY



### BRAZILIAN WALNUT



### LIGHT WALNUT



### GOLD OAK



### WINCHESTER



### WHITE



### STEEL GRAY



### ANTHRACITE



### DARK ANTHRACITE



# OPTIMA 60 DUO DOOR



OPTIMA DUO 60 have been designed for people looking for a custom-size door. A passive door leaf enables a broader passage. Passive door leaves are available both with and without glass, serving as illuminators at the same time.

## PARAMETERS

- ✓ SINGLE- AND MULTI-FAMILY BUILDING ENTRANCE DOOR
- ✓ STEEL DOOR LEAVES 60 MM THICK, FILLED WITH EXPANDED GRAPHITE POLYSTYRENE
- ✓ AVAILABLE WITH PERFOTHERM DOOR FRAME AND ALUMINUM SILL
- ✓ OPTIONALLY, WITH A EXTRA CHARGE, ALUTHERM OPTIMA ALUMINUM DOOR FRAME
- ✓ PASSIVE DOOR LEAVES IN SOLID AND GLAZED DESIGN, IN SIZES 30, 40, 50
- ✓ DOOR AVAILABLE IN 12 COLOURS

DOOR FRAME EXTERNAL DIMENSIONS AND MOUNTING HOLES – SEE PAGES 104–105

## PASSIVE DOOR DESIGNS

The passive door leaf price includes attachment price, as well as sill and door frame EXTRA CHARGE.

NAME	Size
P00	30 40 50
PD4	40
GHI	40 50
GC2	40 50
GN5	30 40 50
GPD	30 40 50
DN3 / DN3B	30 40 50
DN6 / DN6B	30 40 50
DT8 / DT8B	30 40 50
DW9 / DW9B	30 40 50
DW8 / DW8B	30 40 50
DPE / DPEB	30 40 50
PD5	30 40 50
PD5A	30 40 50
PD5B	30 40 50
NMB	30 40 50
NMBA	30 40 50
NMBB	30 40 50
NMA	30 40 50
NMAA	30 40 50
NMAB	30 40 50

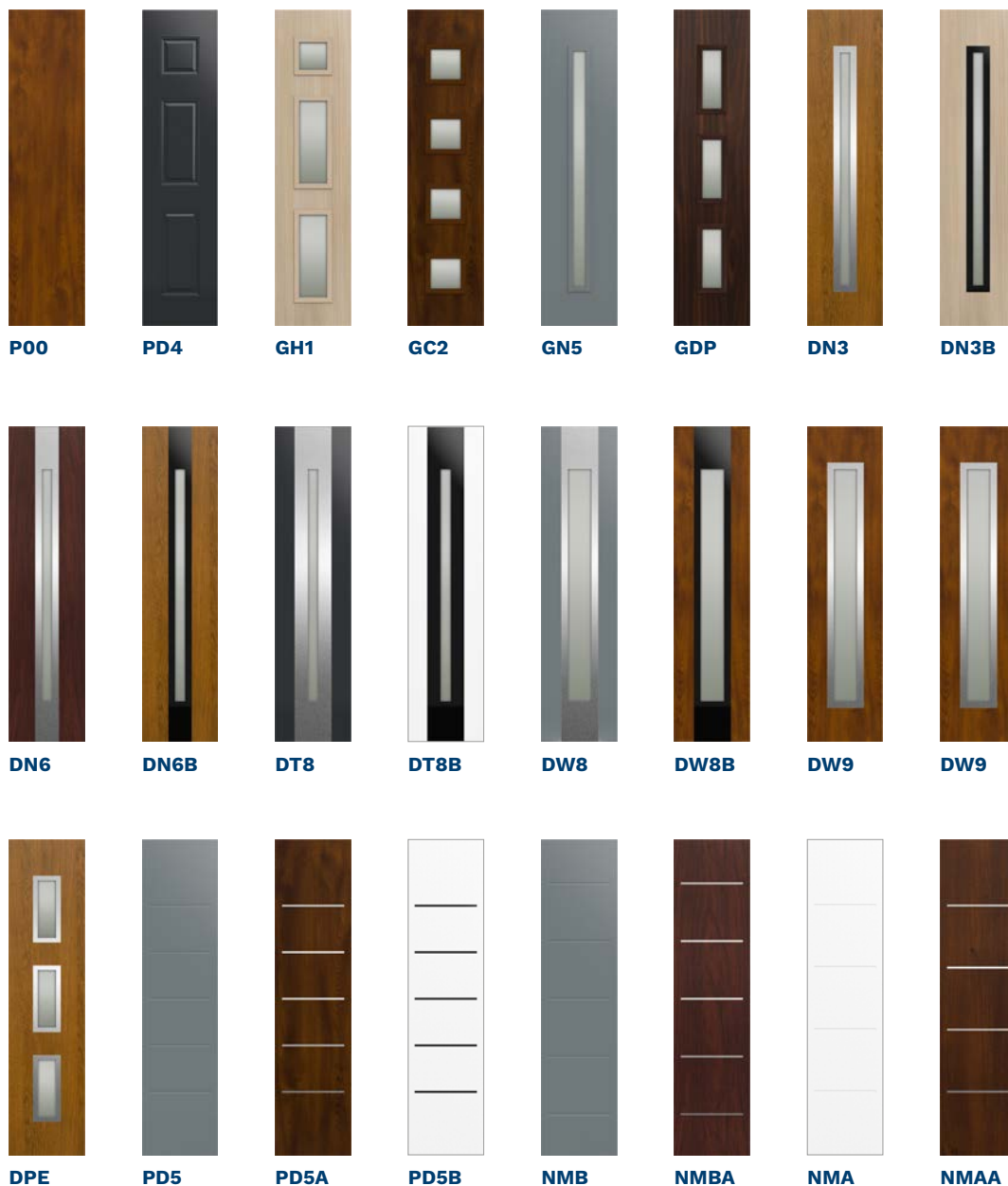



**SOJ BERGAMO2 + NMBA**



**NS5 HANOVER 5 + DW9**



**ST8 RYGA + P00**



**TMMA TOKIO 2A + P00**



**NS9 MILANO 12 + DW8**



**SNUA MILANO 4A + PD5A**



**NT2B TURYN 2B + DT8**



**ST4A UPPSALA 1A + NMAA**



**NS6 HANOVER 6 + DW8**

# ALUMINUM ILLUMINATORS



GL SET



G SET



GP SET



L SET

## ALUMINUM ILLUMINATORS THERMO PRIME 75 DOORS

### ALUTHERM PRIME DOOR FRAME

SIZE	HEIGHT Hz	WIDTH Sc
80	standard 2087 mm custom: 2150 mm	918 mm
90N		988 mm
90E		1031 mm
100E	2200 mm 2250 mm 2300 mm 2350 mm 2400 mm	1131 mm

### SIDE ILLUMINATORS

HEIGHT Hz	ILLUMINATOR / GLASS TYPE	WIDTH Ld/Pd						
		up to 300 mm	up to 400 mm	up to 500 mm	up to 600 mm	up to 700 mm	up to 800 mm	up to 900 mm
2087 mm	ILLUMINATORS WITH SAFETY GLASS	✓	✓	✓	✓	✓	✓	✓
	ANTI-BURGLARY RC2 ILLUMINATORS WITH P4 GLASS	✓	✓	✓	✓	✓	✓	✓
up to 2200 mm	ILLUMINATORS WITH SAFETY GLASS	✓	✓	✓	✓	✓	✓	✓
	ANTI-BURGLARY RC2 ILLUMINATORS WITH P4 GLASS	✓	✓	✓	✓	✓	✓	✓
up to 2300 mm	ILLUMINATORS WITH SAFETY GLASS	✓	✓	✓	✓	✓	✓	✓
	ANTI-BURGLARY RC2 ILLUMINATORS WITH P4 GLASS	✓	✓	✓	✓	✓	✓	✓
up to 2400 mm	ILLUMINATORS WITH SAFETY GLASS	✓	✓	✓	✓	✓	✓	✓
	ANTI-BURGLARY RC2 ILLUMINATORS WITH P4 GLASS	✓	✓	✓	✓	✓	✓	✓

\* SIDE ILLUMINATORS STANDARD WIDTH IN 50 mm INCREMENTS. FOR 10 mm INCREMENTS – 25% EXTRA CHARGE

### TOP ILLUMINATORS

HEIGHT Hd	ILLUMINATOR / GLASS TYPE	WIDTH Ld/B/Pd				
		up to 1150 mm	up to 1550 mm	up to 1950 mm	up to 2350 mm	up to 2950 mm
300 mm	ILLUMINATORS WITH SAFETY GLASS	✓	✓	✓	✓	✓
400 mm		✓	✓	✓	✓	✓
500 mm		✓	✓	✓	✓	✓
300 mm	ANTI-BURGLARY RC2 ILLUMINATORS WITH P4 GLASS	✓	✓	✓	✓	✓
400 mm		✓	✓	✓	✓	✓
500 mm		✓	✓	✓	✓	✓

\* TOP ILLUMINATORS STANDARD WIDTH IN 50 mm INCREMENTS. FOR 10 mm INCREMENTS – 25% EXTRA CHARGE





**P SET**



**LP SET**



**LGP SET**

ALUMINUM ILLUMINATORS FOR THERMO PREMIUM 75, THERMO PREMIUM 60 AND OPTIMA 60 DOORS

### ALUTHERM PREMIUM DOOR FRAME, OPTIMA

SIZE	HEIGHT Hz	WIDTH Sc
<b>80N</b>	2087 mm	888 mm
<b>80</b>		918 mm
<b>90N</b>		988 mm
<b>90E</b>		1031 mm
<b>100E</b>		1131 mm

### SIDE ILLUMINATORS

HEIGHT Hz	ILLUMINATOR / GLASS TYPE	WIDTH Ld/Pd						
		up to 300 mm	up to 400 mm	up to 500 mm	up to 600 mm	up to 700 mm	up to 800 mm	up to 900 mm
2087 mm	ILLUMINATORS WITH SAFETY GLASS	✓	✓	✓	✓	✓	✓	✓
	ANTI-BURGLARY RC2 ILLUMINATORS WITH P4 GLASS	✓	✓	✓	✓	✓	✓	✓

\* SIDE ILLUMINATORS STANDARD WIDTH IN 50 mm INCREMENTS. FOR 10 mm INCREMENTS – 25% EXTRA CHARGE

### TOP ILLUMINATORS

HEIGHT Hc	HEIGHT Hd	ILLUMINATOR / GLASS TYPE	WIDTH Ld/B/Pd				
			up to 1150 mm	up to 1550 mm	up to 1950 mm	up to 2350 mm	up to 2950 mm
2387 mm - 2587 mm	300 mm	ILLUMINATORS WITH SAFETY GLASS	✓	✓	✓	✓	✓
	400 mm		✓	✓	✓	✓	✓
	500 mm		✓	✓	✓	✓	✓
2387 mm - 2587 mm	300 mm	ANTI-BURGLARY RC2 ILLUMINATORS WITH P4 GLASS	✓	✓	✓	✓	✓
	400 mm		✓	✓	✓	✓	✓
	500 mm		✓	✓	✓	✓	✓

\* TOP ILLUMINATORS STANDARD WIDTH IN 50 mm INCREMENTS. FOR 10 mm INCREMENTS – 25% EXTRA CHARGE

# A VARIETY OF COLOURS

# GERDA®

CHOOSE YOUR DOOR COLOUR

ALPINE WALNUT



MAHOGANY



BRAZILIAN WALNUT



LIGHT WALNUT



WHITE

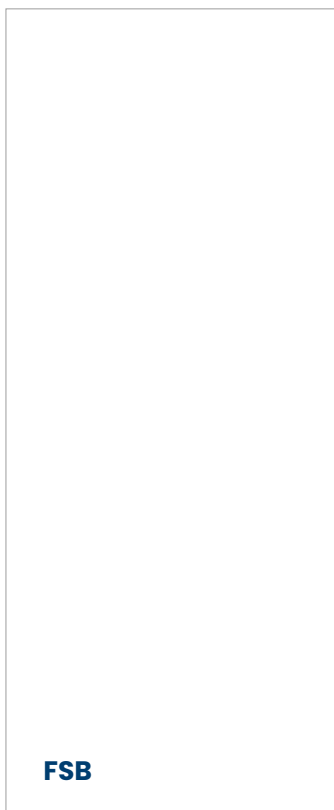

STEEL GRAY

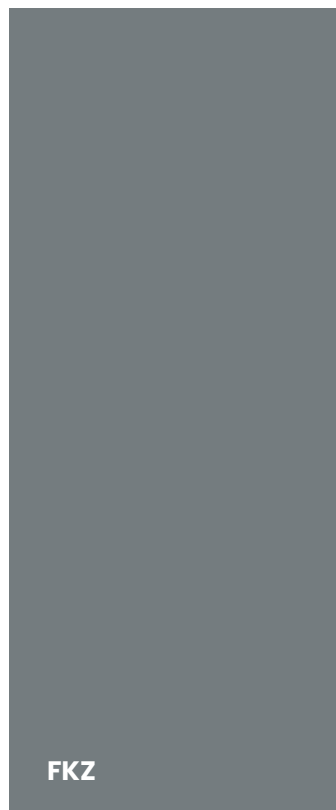

ANTHRACITE

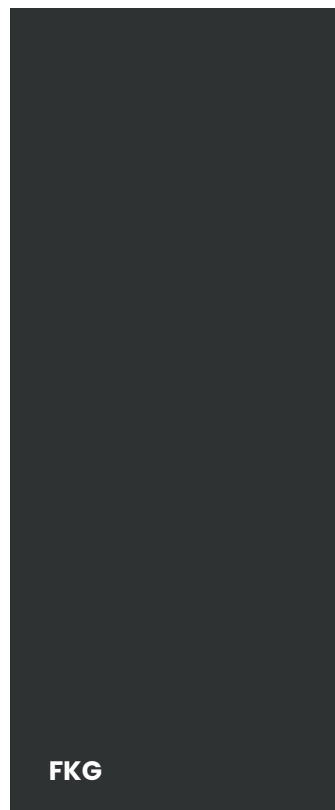

DARK ANTHRACITE

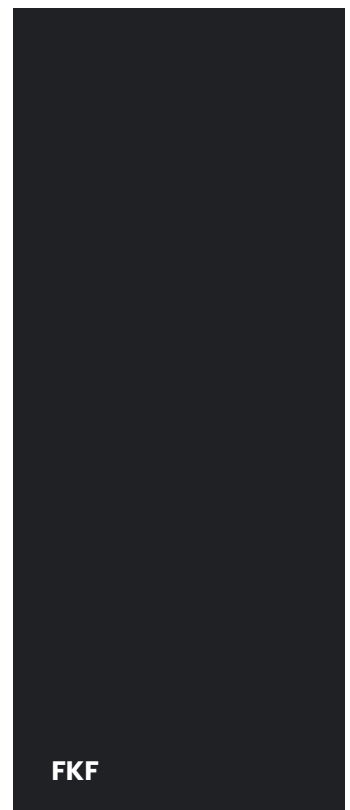

CHOOSE YOUR DOOR COLOUR

GOLD OAK



WINCHESTER



TURNER OAK



LIGHT WENGE



BLACK

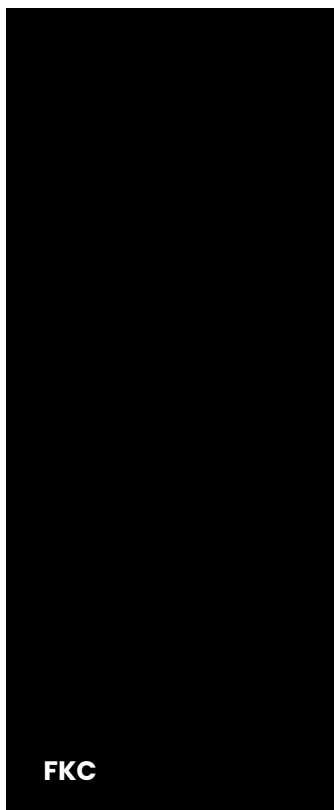

# ACCESSORIES SET

# GERDA®

## THERMO PRIME / THERMO PREMIUM (CONFIGURATION EXAMPLE)

**TW300 BERGEN  
(ALEX HANDLES)  
THERMO PRIME**



**RING ESCUTCHEON  
(ALEX HANDLE ON  
SINGLE-SIDED), HANDHOLD**

AMSTERDAM  MONTREAL



**TD200 BERGEN  
(BETA HANDLES)**



**TD200 BERGEN  
(ALEX KNOB-HANDLE)**



## ESCUTCHEON COLOURS

**PLATINUM ANODE**



**SILVER ANODE**



**BLACK ANODE**



## THERMO PRIME/PREMIUM STANDARD ACCESSORIES SET



THERMO PRIME CLASS 5 INSERT / THERMO PREMIUM CLASS 5 INSERTS IN ONE KEY SYSTEM

**5 KEYS + INSTALLATION**

MAIN LOCK ESCUTCHEON WITH PROTECTION

ADDITIONAL LOCK ESCUTCHEON WITHOUT PROTECTION THERMO PREMIUM

HINGE CAPS IN ESCUTCHEON COLOUR

## EXTRA CHARGES

ESCUTCHEON FOR ADDITIONAL LOCK WITH PROTECTION (THERMO PREMIUM)



KNOB-AND-HANDLE SET



CLASS 6 LOCK CYLINDERS IN A SINGLE KEY SYSTEM



CLASS 5 MAIN LOCK CYLINDER / CLASS 2 ADDITIONAL LOCK CYLINDER (THERMO PREMIUM)



ADJUSTMENT FOR HANDHOLD WITH A BUTTON



AMSTERDAM / MONTREAL HANDHOLD 1800 mm, RECOMMENDED ELECTRIC STRIKE



AMSTERDAM / MONTREAL HANDHOLD 1700 mm, RECOMMENDED ELECTRIC STRIKE



AMSTERDAM / MONTREAL HANDHOLD 1500 mm, RECOMMENDED ELECTRIC STRIKE



AMSTERDAM / MONTREAL HANDHOLD 1000 mm, RECOMMENDED ELECTRIC STRIKE



AMSTERDAM / MONTREAL 1800 mm HANDHOLD WITH A BUTTON, WITH LEAF ADJUSTMENT, RECOMMENDED ELECTRIC STRIKE



AMSTERDAM / MONTREAL 1700 mm HANDHOLD WITH A BUTTON, WITH LEAF ADJUSTMENT, RECOMMENDED ELECTRIC STRIKE



AMSTERDAM / MONTREAL 1500 mm HANDHOLD WITH A BUTTON, WITH LEAF ADJUSTMENT, RECOMMENDED ELECTRIC STRIKE



AMSTERDAM / MONTREAL 1000 mm HANDHOLD WITH A BUTTON, WITH LEAF ADJUSTMENT, RECOMMENDED ELECTRIC STRIKE



TEDEE SET



\*DECORATIVE RING FOR DOORS WITH HANDLE PULLS

### OPTIMA (CONFIGURATION EXAMPLE)

**TW200 BLOK  
(BETA HANDLES)**

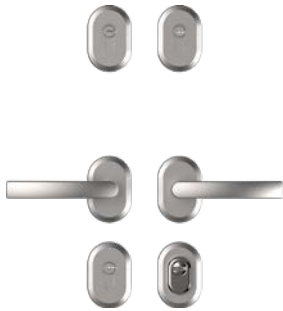

**TW200 BLOK  
(BETA KNOB-HANDLE)**

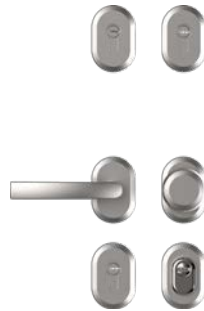

**TW300 BERGEN  
(ALEX HANDLE-HANDLE)**

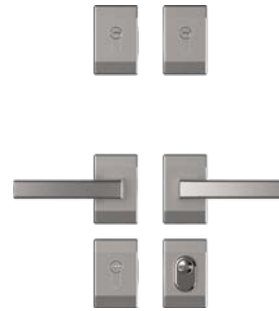

**TW200 BLOK  
(BETA SINGLE-SIDED ON  
SINGLE-SIDED), HANDHOLD**

□ AMSTERDAM ○ MONTREAL



### ESCUTCHEON COLOURS

**PLATINUM ANODE**



**SILVER ANODE**



**BLACK ANODE**



### OPTIMA STANDARD ACCESSORIES SET



CLASS 5 INSERTS IN ONE KEY SYSTEM

**5 KEYS + INSTALLATION**

MAIN LOCK ESCUTCHEON WITH PROTECTION

ADDITIONAL LOCK ESCUTCHEON WITHOUT PROTECTION

HINGE CAPS IN ESCUTCHEON COLOUR

### EXTRA CHARGES

ESCUTCHEON FOR ADDITIONAL LOCK WITH PROTECTION (THERMO PREMIUM)



KNOB-AND-HANDLE SET



CLASS 6 LOCK CYLINDERS IN A SINGLE KEY SYSTEM



CLASS 5 MAIN LOCK CYLINDER / CLASS 2 ADDITIONAL LOCK CYLINDER (THERMO PREMIUM)



ADJUSTMENT FOR HANDHOLD WITH A BUTTON



AMSTERDAM / MONTREAL HANDHOLD 1800 mm, RECOMMENDED ELECTRIC STRIKE



AMSTERDAM / MONTREAL HANDHOLD 1700 mm, RECOMMENDED ELECTRIC STRIKE



AMSTERDAM / MONTREAL HANDHOLD 1500 mm, RECOMMENDED ELECTRIC STRIKE



AMSTERDAM / MONTREAL HANDHOLD 1000 mm, RECOMMENDED ELECTRIC STRIKE



AMSTERDAM / MONTREAL 1800 mm HANDHOLD WITH A BUTTON, WITH LEAF ADJUSTMENT, RECOMMENDED ELECTRIC STRIKE



AMSTERDAM / MONTREAL 1700 mm HANDHOLD WITH A BUTTON, WITH LEAF ADJUSTMENT, RECOMMENDED ELECTRIC STRIKE



AMSTERDAM / MONTREAL 1500 mm HANDHOLD WITH A BUTTON, WITH LEAF ADJUSTMENT, RECOMMENDED ELECTRIC STRIKE



AMSTERDAM / MONTREAL 1000 mm HANDHOLD WITH A BUTTON, WITH LEAF ADJUSTMENT, RECOMMENDED ELECTRIC STRIKE



TEDEE SET



# OPTIONAL EQUIPMENT











# GERDA®

## DOOR SURCHARGES

	OPTIMA 50	OPTIMA 60	THERMO PREMIUM 60	THERMO PREMIUM 75	THERMO PRIME 75
ELECTRIC STRIKE WITH DAY/NIGHT FEATURE, FACTORY-FITTED IN DOOR FRAME (DOOR PRICE SURCHARGE); RECOMMENDED FOR DOORS WITH HANDHOLD; POWER SUPPLY UNIT RECOMMENDED – ADDITIONAL ACCESSORIES, P. 97	✓	✓	✓	✓	✓
ELECTRIC STRIKE WITH DAY/NIGHT FEATURE, FITTED IN ATTACHMENT, RECOMMENDED FOR DOORS WITH HANDHOLDS	-	✓	-	-	-
REED SWITCH FACTORY-FITTED IN DOOR FRAME	✓	✓	✓	✓	✓
DOOR SHORTENING WITHIN THE 0–100 RANGE (FOR SELECTED DESIGNS)	✓	✓	✓	✓	✓
TALLER DOOR; TOTAL HEIGHT UP TO 2400	-	-	-	-	2150 mm; 2200 mm; 2250 mm; 2300 mm; 2350 mm; 2400 mm
TWO-COLOUR DOOR LEAF	✓	✓	✓	✓	✓
INNER DOOR LEAF REINFORCEMENT FOR SURFACE DOOR CLOSER (DOOR PRICE SURCHARGE)	✓	✓	✓	✓	✓
HIDDEN DOOR CLOSER	-	-	✓	✓	-
DRIP EDGE (RECOMMENDED FOR INWARD OPENED DOORS)	✓	✓	✓	✓	✓
ADJUSTMENT FOR HANDHOLD WITH PUSHBUTTON	-	✓	✓	✓	✓

## HANDLES AND ESCUTCHEONS

OPTIMA 50    OPTIMA 60    THERMO PREMIUM 60    THERMO PREMIUM 75    THERMO PRIME 75

	BERGEN – DOUBLE-SIDED HANDLES ON TD200 LONG ESCUTCHEON	-	-	✓	✓	-
	BERGEN – DOUBLE-SIDED HANDLES ON TD1000 LONG ESCUTCHEON	-	-	✓	✓	-
	BERGEN – SINGLE-SIDED HANDLE ON LONG ESCUTCHEON	-	-	✓	✓	-
	BERGEN – HANDLE-KNOB ON TD200 LONG ESCUTCHEON	-	-	✓	✓	-
	BERGEN – HANDLE-KNOB ON TD1000 LONG ESCUTCHEON	-	-	✓	✓	-
	BERGEN – DOUBLE-SIDED HANDLES ON SPLIT ESCUTCHEON	✓	✓	-	-	✓
	BERGEN – SINGLE-SIDED HANDLE ON SPLIT ESCUTCHEON	✓	✓	-	-	✓
	BERGEN – HANDLE-KNOB ON SPLIT ESCUTCHEON	✓	✓	-	-	✓
	BERGEN – SPLIT ESCUTCHEON WITH TW300 KNOB PROTECTION	✓	✓	✓	✓	✓
	BERGEN – SPLIT ESCUTCHEON WITHOUT KNOB PROTECTION	✓	✓	✓	✓	✓

# OPTIONAL EQUIPMENT **GERDA**<sup>®</sup>

## HANDLES AND ESCUTCHEONS

		OPTIMA 50	OPTIMA 60	THERMO PREMIUM 60	THERMO PREMIUM 75	THERMO PRIME 75
	BLOK – DOUBLE-SIDED HANDLES ON SPLIT ESCUTCHEON	✓	✓	-	-	-
	BLOK – SINGLE-SIDED HANDLE ON SPLIT ESCUTCHEON	✓	✓	-	-	-
	BLOK – HANDLE-KNOB ON SPLIT ESCUTCHEON	✓	✓	-	-	-
	BLOK – SPLIT ESCUTCHEON WITH TW200 KNOB PROTECTION	✓	✓	-	-	-
	BLOK – SPLIT ESCUTCHEON WITH TW1000 KNOB PROTECTION	✓	✓	-	-	-
	BLOK – SPLIT ESCUTCHEON WITHOUT KNOB PROTECTION	✓	✓	-	-	-

## HANDHOLDS

		OPTIMA 50	OPTIMA 60	THERMO PREMIUM 60	THERMO PREMIUM 75	THERMO PRIME 75
	AMSTERDAM RECTANGULAR HANDHOLD 1800 (CROSS SECTION 40 x 20 mm)	✓	✓	✓	✓	✓
	AMSTERDAM RECTANGULAR HANDHOLD 1700 (CROSS SECTION 40 x 20 mm)	✓	✓	✓	✓	✓
	AMSTERDAM RECTANGULAR HANDHOLD 1500 (CROSS SECTION 40 x 20 mm)	✓	✓	✓	✓	✓
	AMSTERDAM RECTANGULAR HANDHOLD 1000 (CROSS SECTION 40 x 20 mm)	✓	✓	✓	✓	✓
	AMSTERDAM RECTANGULAR HANDHOLD WITH A BUTTON 1800 (40 x 20 mm SECTION), ELECTRIC DOOR STRIKE REQUIRED	✓	✓	✓	✓	✓
	AMSTERDAM RECTANGULAR HANDHOLD WITH A BUTTON 1700 (40 x 20 mm SECTION), ELECTRIC DOOR STRIKE REQUIRED	✓	✓	✓	✓	✓
	AMSTERDAM RECTANGULAR HANDHOLD WITH A BUTTON 1500 (40 x 20 mm SECTION), ELECTRIC DOOR STRIKE REQUIRED	✓	✓	✓	✓	✓
	AMSTERDAM RECTANGULAR HANDHOLD WITH A BUTTON 1000 (40 x 20 mm SECTION), ELECTRIC DOOR STRIKE REQUIRED	✓	✓	✓	✓	✓
	MONTREAL CIRCULAR HANDHOLD 1800 (Ø 35 mm AXIS)	✓	✓	✓	✓	✓
	MONTREAL CIRCULAR HANDHOLD 1700 (Ø 35 mm AXIS)	✓	✓	✓	✓	✓
	MONTREAL CIRCULAR HANDHOLD 1500 (Ø 35 mm AXIS)	✓	✓	✓	✓	✓
	MONTREAL CIRCULAR HANDHOLD 1000 (Ø 35 mm AXIS)	✓	✓	✓	✓	✓
	MONTREAL CIRCULAR HANDHOLD WITH A BUTTON 1800 (Ø 35 mm AXIS), ELECTRIC DOOR STRIKE REQUIRED	✓	✓	✓	✓	✓
	MONTREAL CIRCULAR HANDHOLD WITH A BUTTON 1700 (Ø 35 mm AXIS), ELECTRIC DOOR STRIKE REQUIRED	✓	✓	✓	✓	✓
	MONTREAL CIRCULAR HANDHOLD WITH A BUTTON 1500 (Ø 35 mm AXIS), ELECTRIC DOOR STRIKE REQUIRED	✓	✓	✓	✓	✓
	MONTREAL CIRCULAR HANDHOLD WITH A BUTTON 1000 (Ø 35 mm AXIS), ELECTRIC DOOR STRIKE REQUIRED	✓	✓	✓	✓	✓



## ACCESSORIES

		OPTIMA 50	OPTIMA 60	THERMO PREMIUM 60	THERMO PREMIUM 75	THERMO PRIME 75
	WIDE-ANGLE VIEWER 50/80	✓	✓	✓	✓	✓
	ELECTRONIC VIEWER 4,3"	✓	✓	✓	✓	✓
	ELECTRONIC VIEWER 2,4"	✓	✓	✓	✓	✓
	ACCESS CONTROL NUMERIC KEYPAD	✓	✓	✓	✓	✓
	BUFFER POWER SUPPLY UNIT AWZG2 – 12V; RECOMMENDED FOR DOORS WITH ELECTRIC STRIKE	✓	✓	✓	✓	✓
	SWITCHING POWER SUPPLY PSC12015; RECOMMENDED FOR DOORS WITH ELECTRIC STRIKE	✓	✓	✓	✓	✓
	LOWER LOCKING PLATE	✓	✓	-	-	-
	HIDDEN DOOR CLOSER	-	-	✓	✓	✓
	DOOR CLOSER GT 1500 STANDARD	✓	✓	✓	✓	✓
	DOOR CLOSER GT 1500 INTERLOCK	✓	✓	✓	✓	✓
	ALUMINIUM DECORATIVE CAPS FOR HINGES	✓	✓	✓	✓	✓
	ALUMINIUM THRESHOLD FOR OPTIMA DOORS 20 mm	✓	✓	-	-	-
	WARM ALUMINIUM THRESHOLD FOR THERMO PRIME, THERMO PREMIUM 20 mm	-	-	✓	✓	✓
	WARM PVC THRESHOLD FOR THERMO PREMIUM 20 mm	-	-	✓	✓	✓
	WOODEN THRESHOLD 19 mm	✓	✓	-	-	-
	DRIP CAP IN THE SAME COLOUR AS THE LEAF	✓	✓	✓	✓	✓

# OPTIONAL EQUIPMENT

# GERDA®

## ACCESSORIES

		OPTIMA 50	OPTIMA 60	THERMO PREMIUM 60	THERMO PREMIUM 75	THERMO PRIME 75
	STEEL-WOODEN SIDE EXTENSION 30 mm (FOR PERFOTHERM, DUOTHERM DOOR FRAMES)	✓	✓	✓	✓	-
	STEEL-WOODEN SIDE EXTENSION 60 mm (FOR PERFOTHERM, DUOTHERM DOOR FRAMES)	✓	✓	✓	✓	-
	ALUMINUM SIDE EXTENSION 28 mm (FOR ALUTHERM DOOR FRAME AND ALUMINUM ILLUMINATOR)	-	✓	✓	✓	-
	ALUMINUM SIDE EXTENSION 52 mm (FOR ALUTHERM DOOR FRAME AND ALUMINUM ILLUMINATOR)	-	✓	✓	✓	-
	ALUMINUM SIDE EXTENSION 114 mm (FOR ALUTHERM DOOR FRAME AND ALUMINUM ILLUMINATOR)	-	✓	✓	✓	-
	ALUMINUM SIDE EXTENSION 25 mm (FOR ALUTHERM PRIME DOOR FRAME)	-	-	-	-	✓
	ALUMINUM SIDE EXTENSION 33 mm (FOR ALUTHERM PRIME DOOR FRAME)	-	-	-	-	✓
	ALUMINUM SIDE EXTENSION 44 mm (FOR ALUTHERM PRIME DOOR FRAME)	-	-	-	-	✓
	ALUMINUM SIDE EXTENSION 55 mm (FOR ALUTHERM PRIME DOOR FRAME)	-	-	-	-	✓
	ALUMINUM SIDE EXTENSION 108 mm (FOR ALUTHERM PRIME DOOR FRAME)	-	-	-	-	✓
	UNDER SILL EXTENSION 30 mm	✓	✓	✓	✓	✓
	SUB SILLS (EXTENSIONS) OF HARDENED EXPANDED POLYSTYRENE. (THERMO PRIME)	-	-	-	-	
						<b>70 mm, 100 mm, 130 mm, 160 mm, 190 mm, 220 mm, 250 mm</b>
	DOOR MAINTENANCE AGENT	✓	✓	✓	✓	✓
	LOCKS AND INSERTS MAINTENANCE AGENT 25 ml	✓	✓	✓	✓	✓
	LOCKS AND INSERTS MAINTENANCE AGENT 100 ml	✓	✓	✓	✓	✓
	LOCKS AND INSERTS MAINTENANCE AGENT 400 ml	✓	✓	✓	✓	✓
	GERDA INOX-1, INOX-2 STAINLESS STEEL CLEANING AGENTS SET	✓	✓	✓	✓	✓
	GERDA RESIST ULTRA DUO TAPES FOR WARM INSTALLATION	✓	✓	✓	✓	✓

### OPTIMA 50 RC2

SIZE	MAIN LOCK	ADDITIONAL LOCK	NUMBER OF KEYS	CYLINDER CLASS
30/45	DRIVER	-	5	2
30/45 ; 45/30	-	DRIVER	5	2
30/45 ; 45/30	DRIVER	DRIVER	5+INSTALLATION	5
30/45 ; 45/30	DRIVER	DRIVER	5+INSTALLATION	6

### OPTIMA 60 RC2

SIZE	MAIN LOCK	ADDITIONAL LOCK	NUMBER OF KEYS	CYLINDER CLASS
35/50	DRIVER	-	5	2
35/50 ; 50/35	-	DRIVER	5	2
35/50 ; 50/35	DRIVER	DRIVER	5+INSTALLATION	5
35/50 ; 50/35	DRIVER	DRIVER	5+INSTALLATION	6

### OPTIMA 60 RC3

SIZE	MAIN LOCK	ADDITIONAL LOCK	NUMBER OF KEYS	CYLINDER CLASS
35/50 ; 50/35	GEAR	DRIVER	5+INSTALLATION	5
35/50 ; 50/35	GEAR	DRIVER	5+INSTALLATION	6

### THERMO PREMIUM 60 RC2

SIZE	MAIN LOCK	ADDITIONAL LOCK	NUMBER OF KEYS	CYLINDER CLASS
35/50	DRIVER	-	5+INSTALLATION	5
35/50 ; 50/35	-	DRIVER	5	2
35/50 ; 50/35	DRIVER	DRIVER	5+INSTALLATION	5
35/50 ; 50/35	DRIVER	DRIVER	5+INSTALLATION	6

### THERMO PREMIUM 60 RC3\*

SIZE	MAIN LOCK	ADDITIONAL LOCK	NUMBER OF KEYS	CYLINDER CLASS
35/50	GEAR	-	5+INSTALLATION	5
35/50 ; 50/35	-	DRIVER	5	2
35/50 ; 50/35	GEAR	DRIVER	5+INSTALLATION	5
35/50 ; 50/35	GEAR	DRIVER	5+INSTALLATION	6

### THERMO PREMIUM 75 RC2/RC3\*

SIZE	MAIN LOCK	ADDITIONAL LOCK	NUMBER OF KEYS	CYLINDER CLASS
45/55	GEAR	-	5+INSTALLATION	5
45/55 ; 55/45	-	DRIVER	5	2
45/55 ; 55/45	GEAR	DRIVER	5+INSTALLATION	5
45/55 ; 55/45	GEAR	DRIVER	5+INSTALLATION	6

### THERMO PRIME 75 RC2

SIZE	MAIN LOCK	ADDITIONAL LOCK	NUMBER OF KEYS	CYLINDER CLASS
45/55	DRIVER	HANDLE / HANDLE INWARDS	5+INSTALLATION	5
30/55	DRIVER	HANDLE / HANDHOLD INWARDS	5+INSTALLATION	5
45/55	DRIVER	HANDLE / HANDLE OUTSIDE	5+INSTALLATION	5
30/45	DRIVER	HANDLE / HANDHOLD OUTSIDE	5+INSTALLATION	5
G55/45	DRIVER	HANDLE / HANDLE INWARDS	5+INSTALLATION	5
G55/35	DRIVER	HANDLE / HANDHOLD INWARDS	5+INSTALLATION	5
G50/50	DRIVER	HANDLE / HANDLE OUTSIDE	5+INSTALLATION	5
G50/35	DRIVER	HANDLE / HANDHOLD OUTSIDE	5+INSTALLATION	5

DOUBLE LOCK DOORS: MAIN LOCK – KEY/KEY INSERT; ADDITIONAL LOCK – KEY/KNOB INSERT.  
SINGLE LOCK DOORS: MAIN LOCK – KEY/KEY OR KEY/KNOB INSERT

# DOOR AND DOOR FRAME DIMENSIONS



## THERMO PRIME DOORS / THERMO PREMIUM LEAF SIZE [mm]

### WIDTH

SIZE	DOOR MODEL	DOOR LEAF WIDTH, NARROW SIDE (Sp)	DOOR LEAF WIDTH, BROAD SIDE (Ss)
80	THERMO PRIME / THERMO PREMIUM	812	842
90N		882	912
90E		925	955
100E		1025	1055

### HEIGHT

DOOR MODEL	HEIGHT	DOOR LEAF HEIGHT, NARROW SIDE (Hs)	DOOR LEAF HEIGHT, BROAD SIDE (Hp)
T. PRIME / T.PREMIUM	2087	2009	2039
THERMO PRIME	2100	2022	2052
	2150	2072	2102
	2200	2122	2152
	2250	2172	2202
	2300	2222	2252
	2350	2272	2302
	2400	2322	2352

## ALUTHERM PRIME / ALUTHERM PREMIUM / DUOTHERM DOOR FRAME SIZE [mm]

SIZE	DOOR FRAME MODEL	TOTAL DOOR FRAME WIDTH (Sc)	RECOMMENDED MOUNTING CUT-OUT WIDTH (Sm)*	TOTAL DOOR FRAME HEIGHT (Hc)	RECOMMENDED MOUNTING CUT-OUT HEIGHT FROM "0" (Hm)
80	DUOTHERM	896	916	2076	2086
90 N		966	986		
90 E		1009	1029		
100 E		1109	1129		
80	ALUTHERM	918	938	STANDARD 2087 CUSTOM**	STANDARD 2097 CUSTOM**
90 N		988	1008		
90 E		1031	1051		
100 E		1131	1151		

\* INCLUDES 10 mm INSTALLATION PLAY

\*\* THERMO PRIME ONLY

# DOOR AND DOOR FRAME DIMENSIONS

## THERMO PRIME 75 / THERMO PREMIUM 75

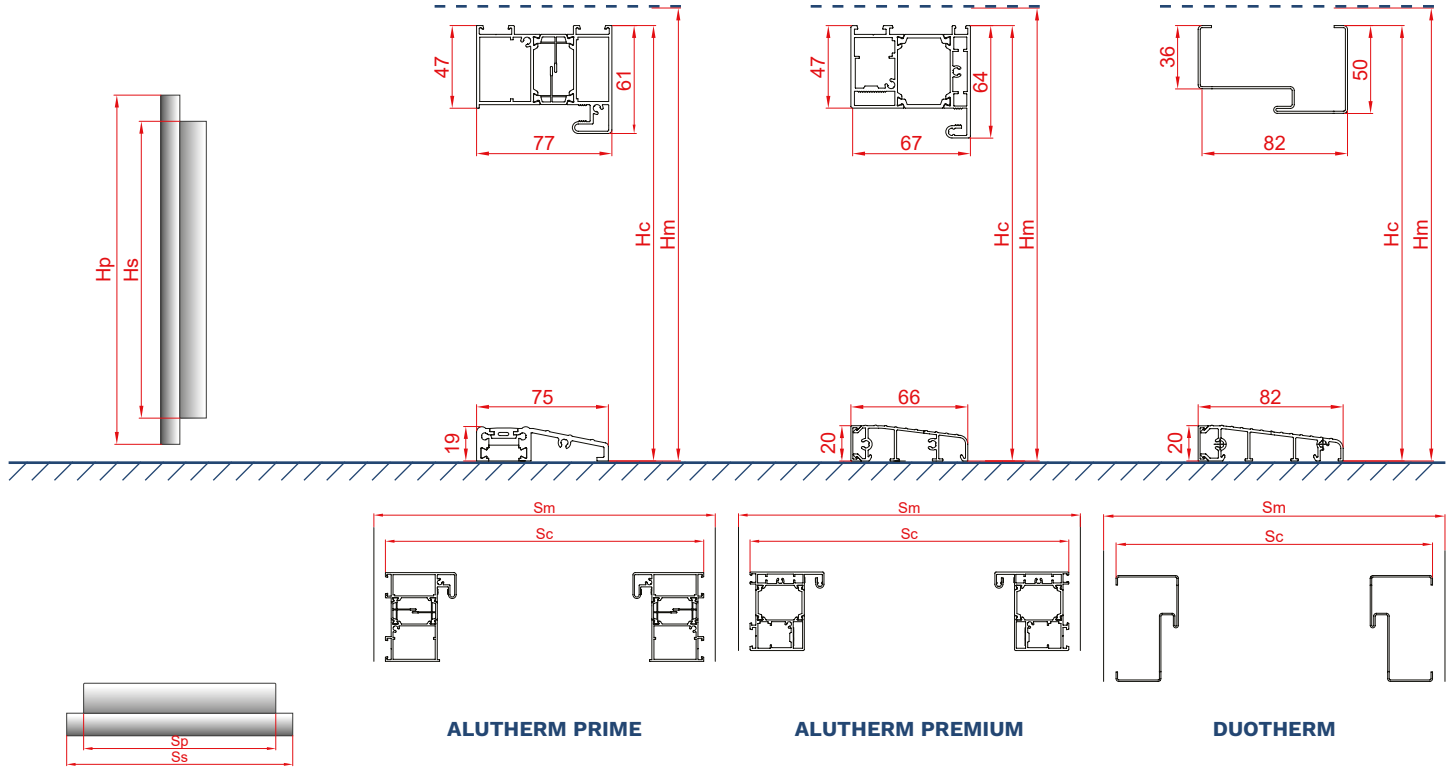

## THERMO PREMIUM 60

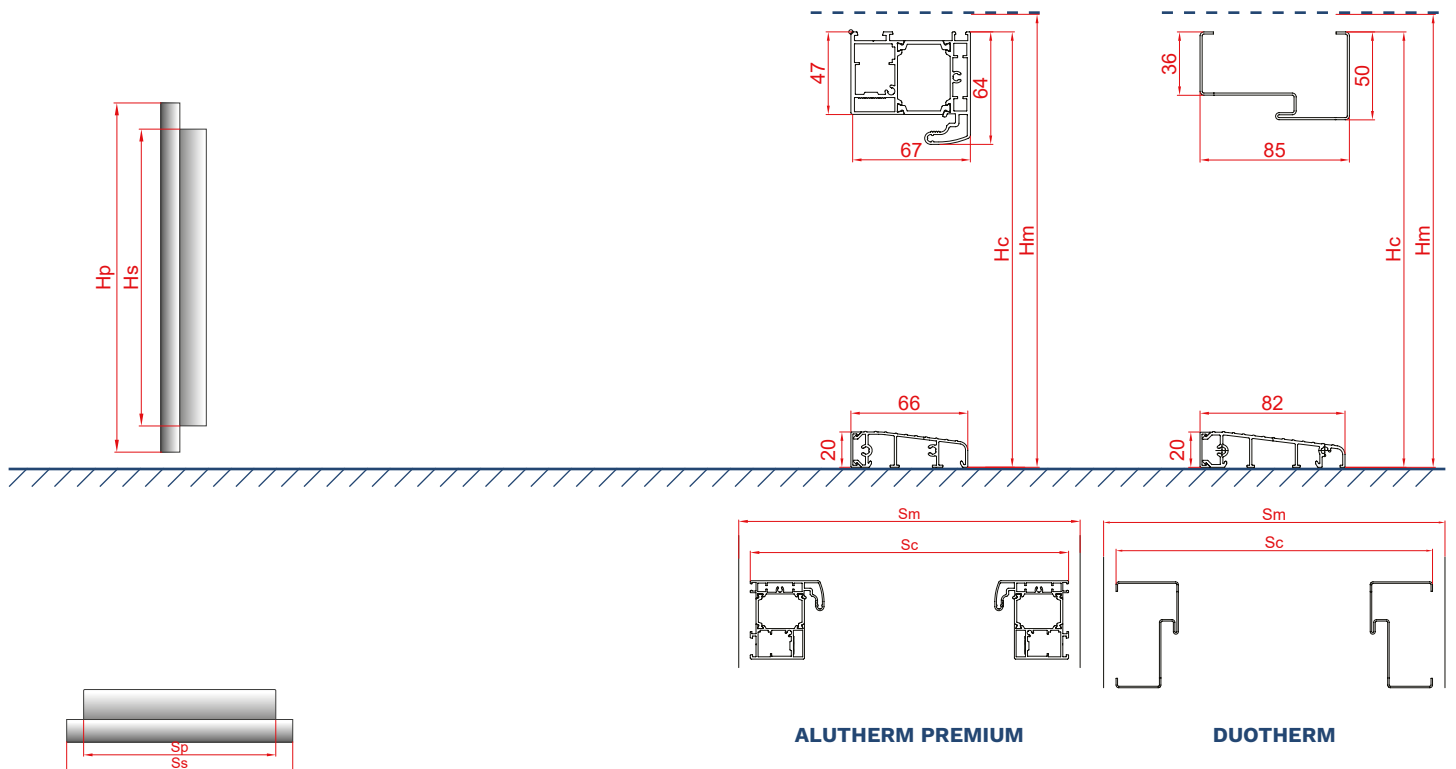

\* AVOID INSTALLING DARK COLOUR DOORS IN AREAS EXPOSED TO DIRECT AND LONG-TERM SUNLIGHT. DOOR INSTALLED AS EXTERIOR ENTRANCE DOOR AT SITES DIRECTLY EXPOSED TO WEATHER CONDITIONS (RAIN, WIND, ETC.) SHOULD OPEN OUTWARDS. IF MOUNTED AS AN EXTERIOR ENTRANCE DOOR, A ROOFING IS REQUIRED.

# DOOR AND DOOR FRAME DIMENSIONS



## OPTIMA DOORS LEAF SIZE [mm]

SIZE	MODEL DRZWI	DOOR LEAF WIDTH, NARROW SIDE (Sp)	DOOR LEAF WIDTH, BROAD SIDE (Ss)	DOOR LEAF HEIGHT, NARROW SIDE (Hs)	DOOR LEAF HEIGHT, BROAD SIDE (Hp)
80N	OPTIMA	782	812	2023	2038,5
80		812	842		
90N		882	912		
90E		925	955		
100E		1025	1055		
30	OPTIMA DUO 60	257	287		
40		357	387		
50		457	487		

## ALUTHERM OPTIMA, PERFOTHERM, FB FRAME SIZE [mm]

SIZE	DOOR FRAME MODEL	TOTAL DOOR FRAME WIDTH (Sc)	RECOMMENDED MOUNTING CUT-OUT WIDTH (Sm)*	TOTAL DOOR FRAME HEIGHT (Hc)	RECOMMENDED MOUNTING CUT-OUT HEIGHT FROM "0" (Hm)
80N	PERFOTHERM, FB	866	886	2076	2086
80		896	916		
90 N		966	986		
90 E		1009	1029		
100 E		1109	1129		
80	ALUTHERM	918	938	2087	2097
90 N		988	1008		
90 E		1031	1051		
100 E		1131	1151		

\* INCLUDES 10 mm INSTALLATION PLAY

# DOOR AND DOOR FRAME DIMENSIONS

## OPTIMA 60

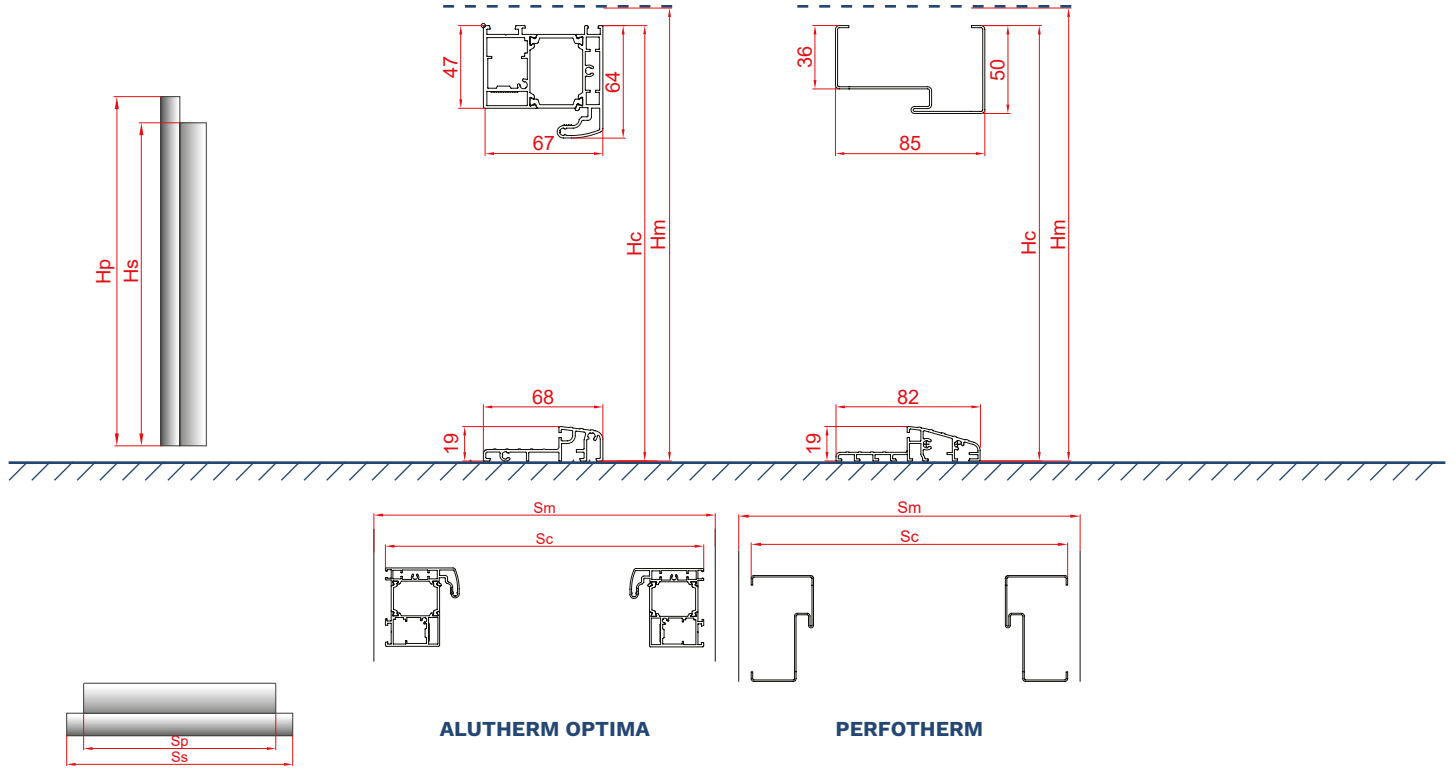

## OPTIMA 50

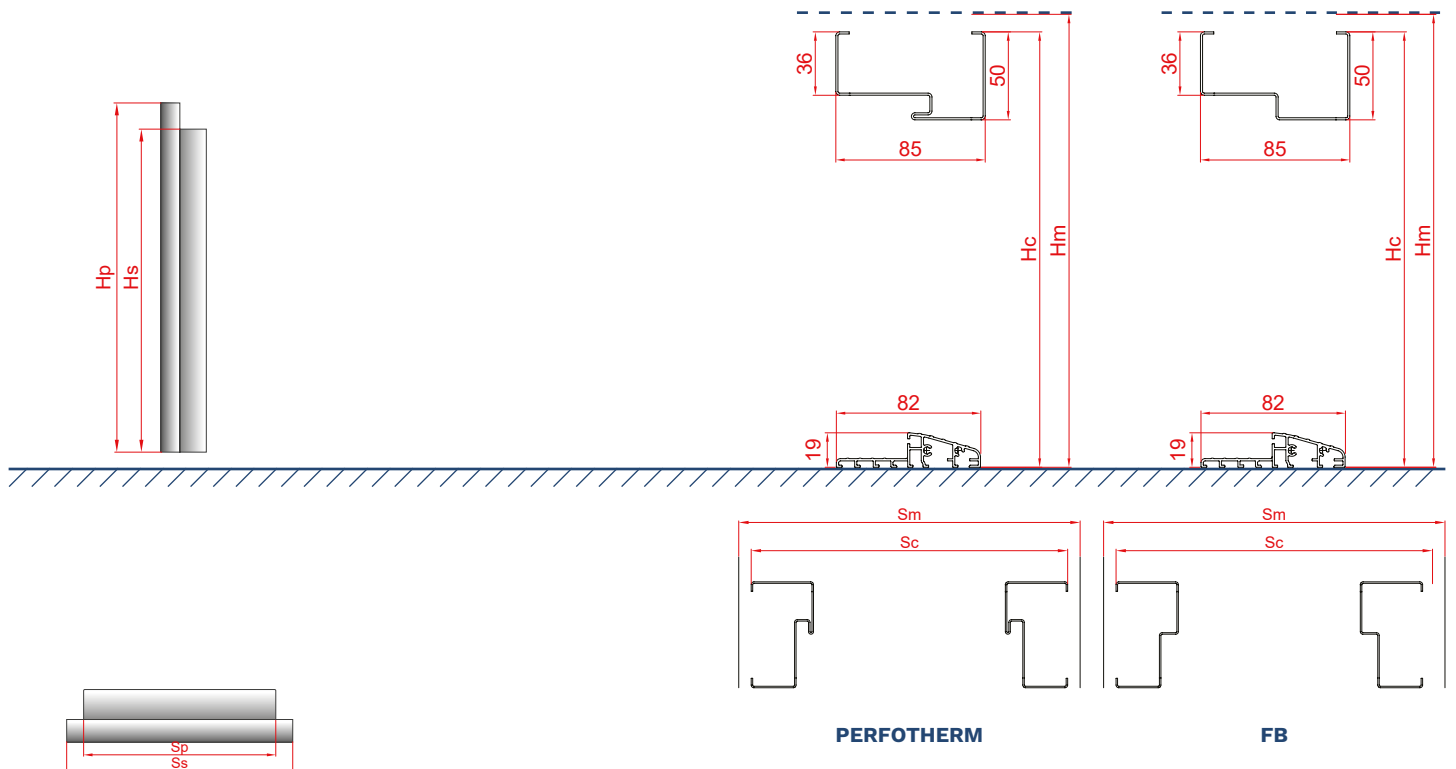

\* AVOID INSTALLING DARK COLOUR DOORS IN AREAS EXPOSED TO DIRECT AND LONG-TERM SUNLIGHT. DOOR INSTALLED AS EXTERIOR ENTRANCE DOOR AT SITES DIRECTLY EXPOSED TO WEATHER CONDITIONS (RAIN, WIND, ETC.) SHOULD OPEN OUTWARDS. IF MOUNTED AS AN EXTERIOR ENTRANCE DOOR, A ROOFING IS REQUIRED.

# DOOR AND DOOR FRAME DIMENSIONS

## FN DOOR FRAME SIZE FOR OPTIMA DOOR [mm]

SIZE	DOOR FRAME MODEL	TOTAL DOOR FRAME WIDTH (Sc1)	TOTAL DOOR FRAME WIDTH (Sc2)	RECOMMENDED MOUNTING CUT-OUT WIDTH (Sm)	TOTAL DOOR FRAME HEIGHT (Hc1)	TOTAL DOOR FRAME HEIGHT (Hc2)	RECOMMENDED MOUNTING CUT-OUT HEIGHT FROM "0" (Hm)
80N	FN	862	797	817	2075	2041	2051
80		892	827	847			
90N		962	897	917			
90E		1005	940	960			
100E		1105	1040	1060			

## ALUTHERM OPTIMA, PERFOTHERM DOOR FRAME SIZE FOR OPTIMA DUO 60 DOORS [mm]

SIZE	ALUTHERM		PERFOTHERM		ALUTHERM		PERFOTHERM	
	TOTAL DOOR FRAME WIDTH (Sc)	RECOMMENDED MOUNTING CUT-OUT WIDTH (Sm)	TOTAL DOOR FRAME WIDTH (Sc)	RECOMMENDED MOUNTING CUT-OUT WIDTH (Sm)*	TOTAL DOOR FRAME HEIGHT (Hc)	RECOMMENDED MOUNTING CUT-OUT HEIGHT FROM "0" (Hm)	TOTAL DOOR FRAME HEIGHT (Hc)	RECOMMENDED MOUNTING CUT-OUT HEIGHT FROM "0" (Hm)
80	918	938	896	916	2087	2097	2076	2086
80+30	1209	1229	1187	1207				
80+40	1309	1329	1287	1307				
80+50	1409	1429	1387	1407				
90 E	1031	1051	1009	1029				
90 E +30	1322	1342	1300	1320				
90 E +40	1422	1442	1400	1420				
90 E +50	1522	1542	1500	1520				
100 E	1131	1151	1109	1129				
100 E +30	1422	1442	1400	1420				
100 E +40	1522	1542	1500	1520				
100 E +50	1622	1642	1600	1620				

\* INCLUDES 10 mm INSTALLATION PLAY

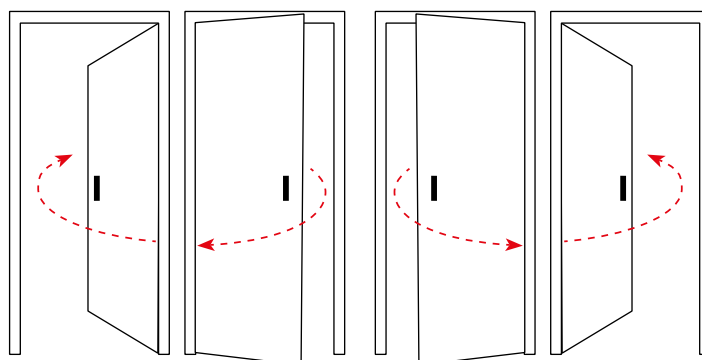

LEFT-HAND DOOR

RIGHT-HAND DOOR



# GERDA® DOOR AND DOOR FRAME DIMENSIONS

## OPTIMA 50

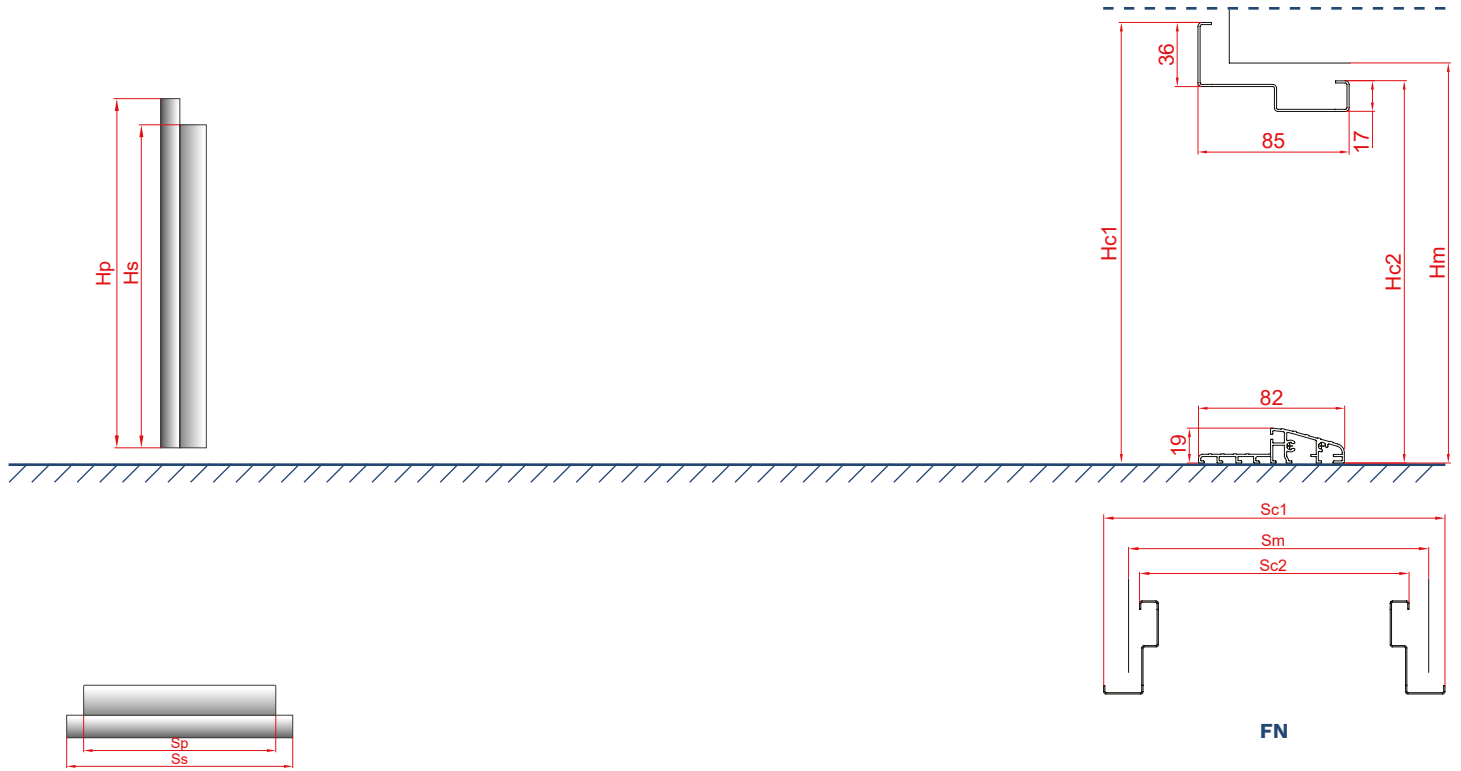

## DUO

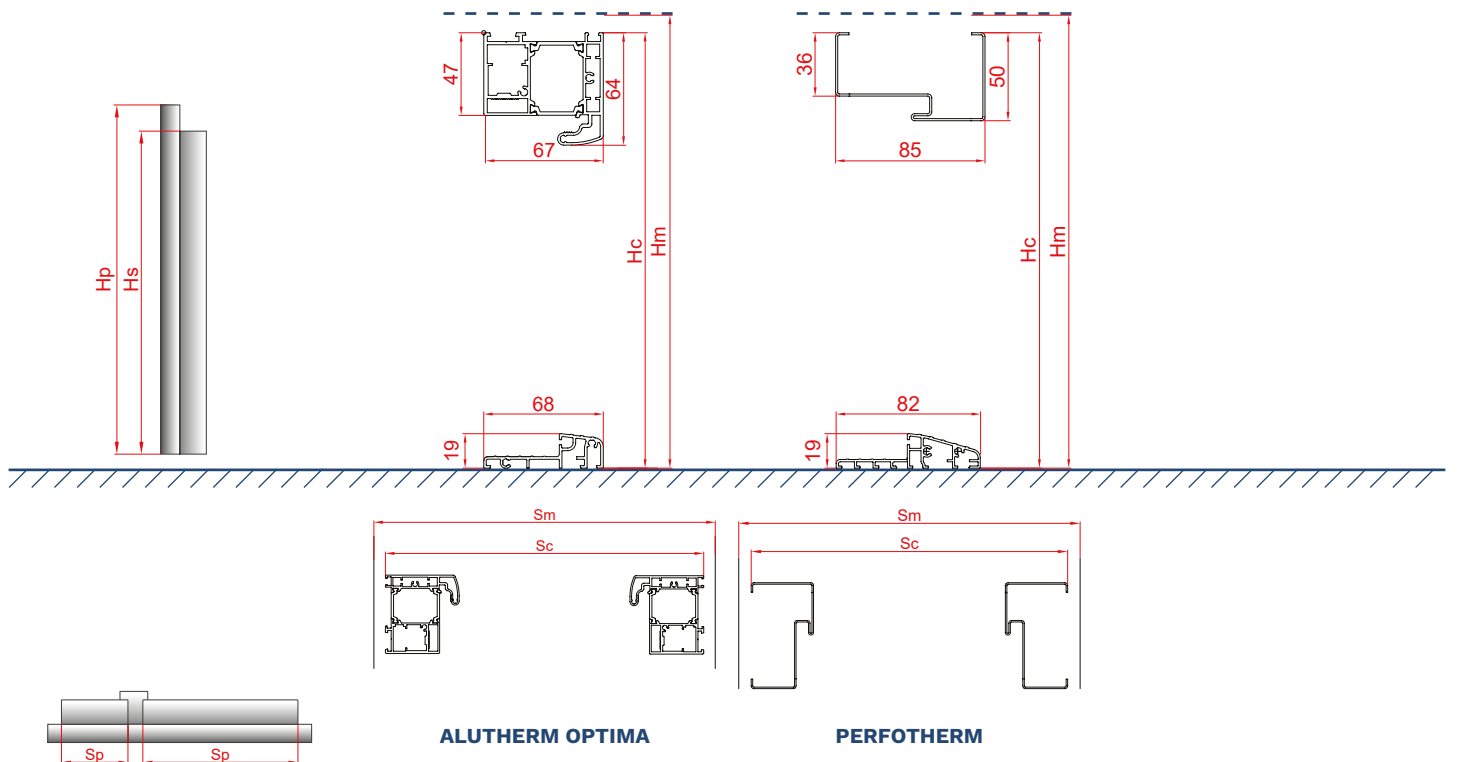

\* AVOID INSTALLING DARK COLOUR DOORS IN AREAS EXPOSED TO DIRECT AND LONG-TERM SUNLIGHT. DOOR INSTALLED AS EXTERIOR ENTRANCE DOOR AT SITES DIRECTLY EXPOSED TO WEATHER CONDITIONS (RAIN, WIND, ETC.) SHOULD OPEN OUTWARDS. IF MOUNTED AS AN EXTERIOR ENTRANCE DOOR, A ROOFING IS REQUIRED.

# INSPIRATIONS HIDDEN IN COMPLETED PROJECTS



# GERDA<sup>®</sup> INSPIRATIONS HIDDEN IN COMPLETED PROJECTS





**Gerda Sp. z o.o.**

Sokołów, ul. Sokołowska 49

05-806 Komorów

Tel.: (+48 22) 329 10 30

[www.gerda.pl](http://www.gerda.pl)

**Distributor:**

This catalogue does not constitute an offer under the provisions of law and is merely informational.

Gerda, committed to continuously improving its products and services, reserves the right (without prior notice) to introduce changes to products that, due to the printing material preparation process, may not be included in this material.

Despite all the effort and care in controlling the presented content, substantial or printing errors may occur.

Colours presented herein may differ from the original due to different colour reproduction technique in the printing process. The owner of the copyright for this catalogue, as well as Gerda logotypes and graphics, is Gerda Sp. z o.o.

It is prohibited to copy or distribute any content and material without the prior consent of Gerda Sp. z o.o.